

Agilent 4287A RF LCR Meter

Programming Manual

Eighth Edition

FIRMWARE REVISIONS/SERIAL NUMBERS

This manual applies directly to instruments that have the firmware revision 2.x and serial number prefix MY433. For additional important information on firmware revisions and serial numbers, see Appendix A.

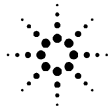

Agilent Technologies

Agilent Part No. 04287-90081

December 2004

Printed in Japan

Notices

The information contained in this document is subject to change without notice.

This document contains proprietary information that is protected by copyright. All rights are reserved. No part of this document may be photocopied, reproduced, or translated to another language without the prior written consent of Agilent Technologies.

Agilent Technologies Japan, Ltd.

Component Test PGU-Kobe

1-3-2 Murotani, Nishi-ku, Kobe, Hyogo, 651-2241 Japan

MS-DOS, Windows, Windows 95, Windows NT, Visual C++, Visual Basic, and Excel are U.S. registered trademarks of Microsoft Corporation.

UNIX is a registered trademark in the United States and other countries, licensed exclusively through X/Open Company Limited.

© Copyright 2000, 2001, 2002, 2003, 2004 Agilent Technologies Japan, Ltd.

Manual Printing History

The manual's printing date and part number indicate its current edition. The printing date changes when a new edition is printed. (Minor corrections and updates that are incorporated at reprint do not cause the date to change.) The manual part number changes when extensive technical changes are incorporated.

January 2000	Preliminary (Agilent P/N: 04287-90001)
February 2000	First Edition (Agilent P/N: 04287-90011)
March 2000	Second Edition (Agilent P/N: 04287-90021)
April 2000	Third Edition (Agilent P/N: 04287-90031)
August 2000	Fourth Edition (Agilent P/N: 04287-90041)
January 2001	Fifth Edition (Agilent P/N: 04287-90051)
November 2002	Sixth Edition (Agilent P/N: 04287-90061)
May 2003	Seventh Edition (Agilent P/N: 04287-90071)
December 2004	Eighth Edition (Agilent P/N: 04287-90081)

Typeface Conventions

Bold	Boldface type is used for terms that are defined. For example: icons are symbols.
<i>Italic</i>	Italic type is used for emphasis and for titles of manuals and other publications.
[Hardkey]	Indicates a hardkey labeled “Hardkey.”
Softkey	Indicates a softkey labeled “Softkey.”
[Hardkey] - Softkey1 - Softkey2	Indicates keystrokes [Hardkey] - Softkey1 - Softkey2 .

Sample Program Disk

A sample program disk (Agilent Part Number 04287-18030) is furnished with this manual. The disk contains the sample programs used in this manual.

The customer shall have the personal, non-transferable rights to use, copy, or modify SAMPLE PROGRAMS in this manual for the Customer’s internal operations. The customer shall use the SAMPLE PROGRAMS solely and exclusively for their own purposes and shall not license, lease, market, or distribute the SAMPLE PROGRAMS or modification of any part thereof.

Agilent Technologies shall not be liable for the quality, performance, or behavior of the SAMPLE PROGRAMS. Agilent Technologies especially disclaims any responsibility for the operation of the SAMPLE PROGRAMS to be uninterrupted or error-free. The SAMPLE PROGRAMS are provided AS IS.

AGILENT TECHNOLOGIES DISCLAIMS ANY IMPLIED WARRANTY OF MERCHANTABILITY AND FITNESS FOR A PARTICULAR PURPOSE.

Agilent Technologies shall not be liable for any infringement of any patent, trademark, copyright, or other proprietary right by the SAMPLE PROGRAMS or their use. Agilent Technologies does not warrant that the SAMPLE PROGRAMS are free from infringements of such rights of third parties. However, Agilent Technologies will not knowingly infringe or deliver software that infringes the patent, trademark, copyright, or other proprietary right of a third party.

4287A Documentation Map

The following manuals are available for the 4287A.

- ***Operation Manual (Agilent P/N: 04287-900x4)***

Basic information needed for using the 4287A is given in this manual. It includes guidelines for installation, preparation, and measurement operations, including calibration, performances (specifications), key definitions, and error messages. For GPIB programming, see the *Programming Manual*.

- ***Programming Manual (Agilent P/N: 04287-900x1)***

The Programming Manual shows how to write and use BASIC programs to control the 4287A.

1. To Make Effective Use of This Manual	
Contents of This Manual	14
How To Use This Manual	17
Looking up GPIB commands	17
Using sample programs	17
2. Overview of Remote Control	
Setting Up a GPIB Remote Control System	20
What is GPIB?	20
How to set up a GPIB remote control system	20
Device selector	21
Sending GPIB Command Messages	22
Types and structure of GPIB commands	22
Message syntax	23
Remote mode	24
3. Specifying Measurement Conditions	
Setting Measurement Parameters	26
Setting Measurement Point Setup Tables (Signal Source and Averaging Factor)	27
Choosing Whether to Measure the DUT at a Single Point or Multiple Points	28
Configuring the Instrument for Rdc Measurement	28
Turning on/off the Rdc measurement function	28
Turning on/off the offset cancel function	28
Setting the limit range for Rdc measurement	28
Setting How the Instrument Displays Measurement Results (Enabling/Disabling Deviation Measurement Mode)	29
Configuring Screen Display	30
Configuring the display of measurement results	30
Setting the display items on the list measurement screen	31
Turning on/off the display	31
Turning on/off the update of the display	31
Turning on/off the backlight of the LCD screen	31
Showing or hiding the title	31
Turning on/off the date display	31
Sample Program	32
4. Preparing for Accurate Measurement	
Performing Calibration	38
Setting calibration kit values	38
Measuring data for calculating calibration coefficients and turning on calibration function	38
Preventing operational errors when measuring data for calculating calibration coefficients	40
Saving or recalling calibrated state (retrieving or writing calibration coefficients)	41
Sample program	42
Selecting a Test Fixture (Port Extension Compensation)	51
Using port extension compensation function	51
Configuring the instrument to use your custom test fixture	51
Running the Compensation Process	52
Setting compensation kit values	52

Measuring data for calculating compensation coefficients	52
Calculating compensation coefficients and turning on/off compensation function	54
Preventing operational errors when measuring data for calculating compensation coefficients	54
Saving or recalling compensated state (retrieving or writing compensation coefficients).	55
Sample program	56
5. Starting Measurement Cycle (Triggering) and Detecting End of Measurement	
Starting a New Measurement Cycle (Triggering)	66
Trigger system.	66
Starting a measurement cycle (Triggering the instrument).	69
Waiting for (Detecting) End of Measurement.	70
Sample program	71
6. Retrieving Measurement Results	
Data Transfer Format	74
ASCII format	75
Binary format	76
Internal Data Processing.	77
Data flow.	77
Internal data arrays	78
Retrieving the Measurement Results for Measurement Parameters 1 through 4.	85
Using the *TRG command to retrieve measurement results	86
Using the :FETC? or :DATA:FDAT{1-4}? command to retrieve measurement results	90
Using the :READ? command to retrieve measurement results	96
Retrieving the Monitored Values of Test Signal Levels.	99
Retrieving the Results of Rdc Measurement	101
Retrieving measurement results	101
Retrieving limit test results.	101
Sample program	102
7. Sorting DUTs Based on Measurement Results	
Setting Up the Bin Sorting Function	106
Turning on/off the bin sorting function (comparator).	106
Setting the beep condition.	106
Setting the sorting conditions for each bin	106
Retrieving the Results of Bin Sorting.	110
Retrieving the Number of the DUTs Sorted into Each Bin (Using the Bin Count Function)	111
Sample Program	112
8. Statistical Analysis of Measurement Results	
Capturing the Measurement Data for Statistical Analysis	118
Setting the number of data segments to capture	118
Starting data capture	118
Completion of data capture.	118
Saving the captured data.	118
Performing Statistical Analysis	119
Sample Program	120

9. Saving and Recalling Files	
Saving and Recalling Files	126
Specifying the file	126
Saving data to a file	126
Recalling a file	127
Automatically recalling a file	127
Managing a file	127
Sample Program	128
10. Error Handling	
Using the Error Queue	134
Using the Status Reporting System.	135
Sample Program	136
11. Shutting Down the Instrument	
Shutdown Procedure	140
12. Connecting the Instrument to a Handler with the Handler Interface	
Input/Output Signal Pin Layout	142
Outputting Bin Sort Results	144
Timing Chart.	146
Electrical Characteristics	147
Output signals	147
Input signals	149
Output signal pull-up/input signal drive voltage.	150
Modification of the Handler Interface	151
Setting the drive/pull-up power supply	151
Setting the pull-up resistors.	152
Procedure for removing the handler interface board	154
13. Using LAN	
Advantages of LAN Connections	158
Preparing to Use a LAN	159
Setting up LAN connections.	159
Connecting to a LAN	160
Transferring Files	161
File transfer procedure using ftp	161
File transfer procedure using a file transfer application	162
Interactive Control by Telnet	164
14. Sample Application Programs	
Measuring the DUT with a Test Fixture	168
Using an Auto-sorting System	176
Measuring Array (Multi-Element) Components.	186
Sample Program	187
15. Command Reference	

Contents

Notational Conventions in this Command Reference	196
Syntax	196
Description	196
Parameters	196
Query response	197
See also	197
Equivalent key sequence	197
IEEE Common Commands	198
*CLS	198
*ESE	198
*ESR?	199
*IDN?	199
*OPC	199
*OPC?	199
*RST	200
*SRE	201
*STB?	201
*TRG	202
*TST?	202
*WAI	202
4287A GPIB Commands	203
:ABOR	203
:AVER:COUN	204
:CALC:COMP	205
:CALC:COMP:BEEP:COND	205
:CALC:COMP:BIN{1-13}	206
:CALC:COMP:BIN{1-13}:COND{1-4}:LIM	207
:CALC:COMP:BIN{1-13}:COND{1-4}:LTY	208
:CALC:COMP:CLE	208
:CALC:COMP:COND{1-4}:MODE	209
:CALC:COMP:COND{1-4}:NOM	210
:CALC:COMP:COND{1-4}:PAR	211
:CALC:COMP:COND{1-4}:SNUM	212
:CALC:COMP:COUN	213
:CALC:COMP:COUN:CLE	213
:CALC:COMP:DATA:BCOU?	214
:CALC:COMP:DATA:BIN?	215
:CALC:COMP:DATA:RDC?	216
:CALC:COMP:OGB	217
:CALC:COMP:RDC:LIM	218
:CALC:EXAM:GET?	219
:CALC:EXAM:POIN?	220
:CALC:EXAM:SIZE	221
:CALC:EXAM:STAR	222
:CALC:PAR{1-4}:EXPR:CENT	222
:CALC:PAR{1-4}:EXPR:NAME	223
:CALC:PAR{1-4}:EXPR:STAT	223
:CALC:PAR{1-4}:FORM	224
:CORR1?	225

:CORR1:CKIT	225
:CORR1:CKIT:LIST	226
:CORR1:CKIT:STAN1:DC	227
:CORR1:CKIT:STAN1:EDEL	228
:CORR1:CKIT:STAN1:LIST	229
:CORR1:CKIT:STAN2:DC	230
:CORR1:CKIT:STAN2:EDEL	231
:CORR1:CKIT:STAN2:LIST	232
:CORR1:CKIT:STAN3:DC	233
:CORR1:CKIT:STAN3:EDEL	234
:CORR1:CKIT:STAN3:FORM	235
:CORR1:CKIT:STAN3:LIST	236
:CORR1:COLL	238
:CORR1:COLL:DC	239
:CORR1:COLL:RF	240
:CORR1:COLL:SAVE	240
:CORR2:CKIT	241
:CORR2:CKIT:LIST	241
:CORR2:CKIT:STAN1:DC	242
:CORR2:CKIT:STAN1:LIST	243
:CORR2:CKIT:STAN2:DC	244
:CORR2:CKIT:STAN2:LIST	245
:CORR2:COLL	246
:CORR2:COLL:DC	247
:CORR2:COLL:OPEN	248
:CORR2:COLL:RF	248
:CORR2:COLL:SAVE	249
:CORR2:COLL:SHOR	249
:CORR2:FIXT	250
:CORR2:FIXT:EDEL:DIST	251
:CORR2:FIXT:LAB	252
:DATA:CAD{1-8}?	253
:DATA:CCO{1-6}	254
:DATA:CMD{1-2}?	255
:DATA:CMP{1-3}	256
:DATA:FDAT{1-4}?	257
:DATA:IMON?	257
:DATA:RAW?	258
:DATA:RCAD{1-3}?	259
:DATA:RCCO{1-3}	259
:DATA:RCMD{1-2}?	260
:DATA:RCMP{1-3}	260
:DATA:RDC?	261
:DATA:VMON?	261
:DISP	262
:DISP:BACK	262
:DISP:CCL	263
:DISP:TEXT1	263
:DISP:TEXT1:CALC{1-4}	264

Contents

:DISP:TEXT1:CALC{1-4}:DIG	264
:DISP:TEXT1:CALC{1-4}:FIX	265
:DISP:TEXT1:CALC{1-4}:MSD	265
:DISP:TEXT1:CALC{11-12}	266
:DISP:TEXT1:CALC{11-12}:DIG	266
:DISP:TEXT1:CALC{11-12}:FIX	267
:DISP:TEXT1:CALC{11-12}:MSD	267
:DISP:TEXT1:CALC13:DIG	268
:DISP:TEXT1:CALC13:FIX	268
:DISP:TEXT1:CALC13:MSD	269
:DISP:TEXT10	270
:DISP:TEXT10:DATA	270
:DISP:TEXT11	271
:DISP:TEXT11:MODE	271
:DISP:TEXT2:LAB{1-4}	272
:DISP:UPD	273
:FETC?	274
:FORM	276
:FORM:BORD	277
:HCOP	278
:HCOP:ABOR	278
:HCOP:CONT	278
:HCOP:DPR	279
:HCOP:IMAG	280
:HCOP:PRIN?	280
:INIT	281
:INIT:CONT	281
:MMEM:CAT?	282
:MMEM:COPY	283
:MMEM:CRE:DIR	283
:MMEM:DEL	284
:MMEM:LOAD	284
:MMEM:STOR	285
:READ?	287
:SOUR:LIST	288
:SOUR:LIST:CLE	289
:SOUR:LIST:POIN	289
:SOUR:LIST:RDC	290
:SOUR:LIST:RDC:OFSC	290
:SOUR:LIST:SIZE?	290
:SOUR:LIST:STAT	291
:SOUR:LIST:TABL	291
:SOUR:UNIT	292
:STAT:OPER?	293
:STAT:OPER:COND?	293
:STAT:OPER:ENAB	293
:STAT:OPER:NTR	294
:STAT:OPER:PTR	294
:STAT:PRES	295

:STAT:QUES?	295
:STAT:QUES:ENAB	295
:SYST:BEEP1	296
:SYST:BEEP1:STAT	296
:SYST:BEEP2	296
:SYST:BEEP2:STAT	297
:SYST:DATE	297
:SYST:ERR?	298
:SYST:ERR:COUN?	298
:SYST:EXTR?	298
:SYST:KLOC	299
:SYST:KLOC:KBD	299
:SYST:KLOC:MOUS	300
:SYST:POFF	300
:SYST:PRES	300
:SYST:TIME	301
:SYST:VERS?	301
:TRIG	302
:TRIG:DEL	302
:TRIG:SEQ2:DEL	303
:TRIG:SLOP	303
:TRIG:SOUR	304
Service command	305
A. Manual Changes	
Manual Changes	308
Change 1	309
Change 2	309
Change 3	309
B. Status Reporting System	
General Status Register Model	312
Event register	313
Enable register	313
Status byte register	313
Condition register and transition filter	314
Status Register Structure	315
Using the Status Reporting System	319
C. GPIB Command Table	
GPIB Command Table	322
D. GPIB Command Tree	
Command Tree	332
E. 4286A vs. 4287A GPIB Commands Correspondence Table	
4286A vs. 4287A GPIB Commands Correspondence Table	338

F. List of Responses to Measurement Failure	
Responses to Measurement Failure	350
G. Initial Settings	
Initial Settings, Settings that can be Saved/Recalled, Settings that can be Backed Up	352
H. Using Printer	
Printer Support	360
Preparation for Printing	361
Checking supported printers	361
Selecting a printer	361
Outputting the Data to the Printer	362
Selecting what to output	362
Selecting the color scheme	362
Starting a print operation	362
Canceling the print operating	362
Sample Program	363
I. Error messages	
Order of error number	368

1 To Make Effective Use of This Manual

This chapter provides an overview of this manual as well as useful information to help you navigate through the manual. It also briefly describes how to use this manual, focusing on how you can look up particular commands.

Contents of This Manual

This manual is a programming guide for the Agilent 4287A RF LCR meter. In addition to explanations of how to remotely control the 4287A from BASIC programs, it provides listings and in-depth descriptions of sample HP BASIC programs. The chapter-by-chapter contents of this manual are as follows.

Chapter 1 “To Make Effective Use of This Manual”

This chapter provides an overview of this manual as well as useful information to help you navigate through the manual. It also briefly describes how to use this manual, focusing on how you can look up particular commands.

Chapter 2 “Overview of Remote Control”

This chapter gives an overview of the GPIB remote control system and GPIB commands.

Chapter 3 “Specifying Measurement Conditions”

This chapter explains how to set measurement conditions and configure the instrument’s display of measurement results.

Chapter 4 “Preparing for Accurate Measurement”

This chapter explains how to carry out calibration, compensation, and test fixture selection (port extension compensation).

Chapter 5 “Starting Measurement Cycle (Triggering) and Detecting End of Measurement”

This chapter explains how to trigger the instrument to start a new measurement cycle and how to detect the end of a measurement cycle.

Chapter 6 “Retrieving Measurement Results”

This chapter explains how to retrieve the results of impedance measurement, test signal level monitoring, and Rdc measurement. It also describes how the Agilent 4287A internally processes the data.

Chapter 7 “Sorting DUTs Based on Measurement Results”

This chapter explains how to use the bin sorting function to sort DUTs into a number of configured bins based on measurement results.

Chapter 8 “Statistical Analysis of Measurement Results”

This chapter explains how to use the statistical analysis function.

Chapter 9 “Saving and Recalling Files”

This chapter explains how to save or recall instrument settings and measurement results to or from a file.

Chapter 10 “Error Handling”

This chapter explains how to handle errors that may occur in the Agilent 4287A while running a program.

Chapter 11 “Shutting Down the Instrument”

This chapter explains how to shut down the Agilent 4287A.

Chapter 12 “Connecting the Instrument to a Handler with the Handler Interface”

You can use the handler interface of the Agilent 4287A to communicate with an external handler; for example, the 4287A can send end-of-measurement signals or bin-sorting results and receive external trigger or key lock signals. This chapter provides the information needed to set up an auto-sorting system that combines the 4287A with a handler by taking advantage of the handler interface and bin sorting.

Chapter 13 “Using LAN”

This chapter describes LAN (Local Area Network)-based file transfer and remote control.

Chapter 14 “Sample Application Programs”

This chapter provides sample measurements (sample programs).

Chapter 15 “Command Reference”

This chapter provides a GPIB command reference for the Agilent 4287A. The shorthand names of the commands, without the parts that are normally omitted, appear in alphabetical order in this chapter. If you want to search for commands by their full names, see “GPIB commands” in the index. If you want to search for commands by their functionality, see Appendix C, “GPIB Command Table.”

Appendix A “Manual Changes”

This appendix contains the information required to adapt this manual to earlier versions or configurations of the Agilent 4287A than that indicated by the current printing date of this manual. The information in this manual applies directly to the 4287A model that has the serial number prefix listed on the title page of this manual.

Appendix B “Status Reporting System”

This appendix describes the status reporting system of the Agilent 4287A.

Appendix C “GPIB Command Table”

This appendix provides the Agilent 4287A GPIB command list sorted according to function.

Appendix D “GPIB Command Tree”

This appendix provides the Agilent 4287A GPIB command tree.

Appendix E “4286A vs. 4287A GPIB Commands Correspondence Table.”

This appendix gives the correspondence between the Agilent 4287A GPIB commands and those of the Agilent 4286A.

To Make Effective Use of This Manual
Contents of This Manual

Appendix F “List of Responses to Measurement Failure”

This appendix summarizes how the Agilent 4287A responds when a measurement fails (an overloading or exceeding the Rdc limit range is detected).

Appendix G “Initial Settings”

This appendix provides initial settings, settings that can be saved/recalled, and settings that can be backed up.

Chapter H “Using Printer”

This chapter explains how to use a printer to produce hard copies of your measurement results and images displayed on the LCD screen.

Appendix I “Error messages”

The Agilent 4287A provides error messages to indicate its operating status. This appendix describes the error messages of the 4287A in order of error number. To search error messages alphabetically, refer to the Operation Manual.

How To Use This Manual

Chapters 3 to 11 provide task-based descriptions of GPIB commands that are useful for programming and explain how you can utilize them. These chapters contain explanations and sample program listings that you can use to develop your custom programs. For more information on individual commands, see Chapter 15 “Command Reference.”

Looking up GPIB commands

Chapter 15, “Command Reference,” contains a complete reference of GPIB commands. You can look up a particular GPIB command in any of the following ways:

Lookup by Abbreviated Command Name

The command reference is organized alphabetically according to the abbreviated name used as the title of each command.

Lookup by Full Command Name

You can use the index at the end of the manual to find full command names along with the page numbers where they appear.

Lookup by Command Function

Appendix C, “GPIB Command Table,” provides a complete list of commands by function and indicates the page numbers where the commands appear in the command reference.

NOTE

Some GPIB commands supported by the 4287A have optional syntax elements. In the command reference conventions, these elements are enclosed between square brackets ([]) or printed in lowercase letters. See “Syntax” on page 196 for more information.

Using sample programs

This manual comes with a sample program disk, which contains the source files of sample programs used in the manual. The disk is DOS-formatted and the files are saved in the ASCII format.

Loading a sample program

To load a sample program into the HP BASIC interpreter, use the GET command. For example, you can load setup.bas, one of the sample programs, by the following procedure:

In the HP BASIC screen, type the following command and press the Return key.

```
GET "setup.bas"
```

Looking up a sample program

To look up the description of a sample program you are interested in, see “Sample program” in the index.

To Make Effective Use of This Manual
How To Use This Manual

2 Overview of Remote Control

This chapter gives an overview of the GPIB remote control system and GPIB commands.

Setting Up a GPIB Remote Control System

This section describes how to set up a GPIB remote control system.

What is GPIB?

GPIB (General Purpose Interface Bus) is an interface standard for connecting a computer with peripherals. It complies with these international standards: IEEE 488.1, IEC-625, IEEE 488.2, and JIS-C1901. With the GPIB interface, you can set up a GPIB remote control system in which an external computer remotely controls the Agilent 4287A by sending commands to and receiving data from the unit through the GPIB bus.

How to set up a GPIB remote control system

Use GPIB cables to connect the 4287A to an external controller (computer) and any necessary peripherals. Figure 2-1 shows a typical GPIB remote control system.

Figure 2-1

Setting up a GPIB remote control system

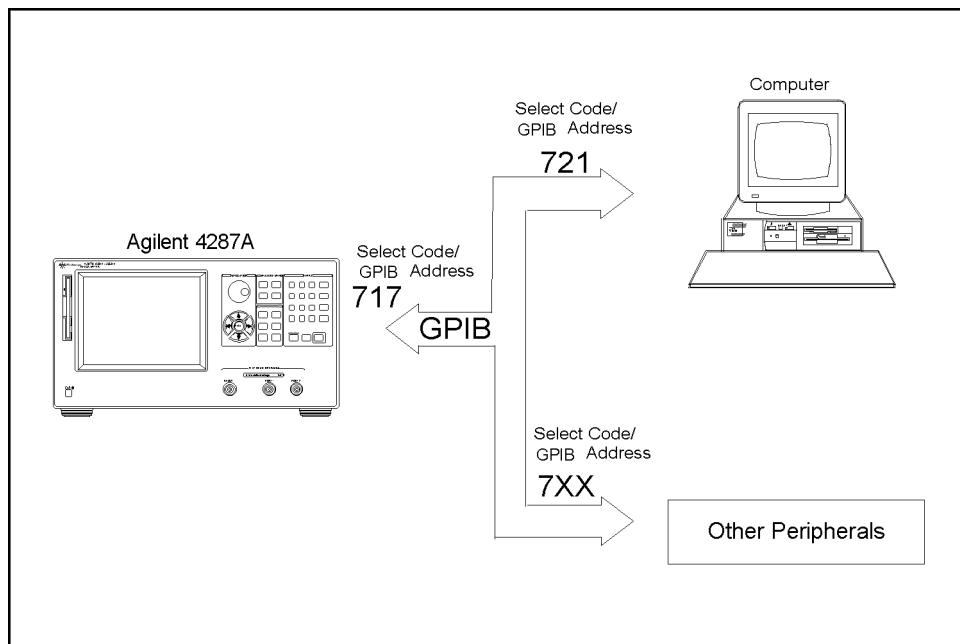

4287ape019

Required equipment

1. 4287A with accessories for measuring DUTs
2. External controller (computer)
The external controller can be any personal computer or workstation with a GPIB interface card and the appropriate software (such as HP BASIC for Windows) for controlling the instrument via the GPIB interface.
3. Other hardware as needed (extra instruments and/or peripherals)
4. GPIB cables for connecting the 4287A to the external controller and other hardware

Possible sizes and configurations of your remote control system

- One GPIB system can host up to 15 devices.
- Device-to-device cables should be no longer than 4 m. The total length of connection cables used in one GPIB system should not exceed $2\text{ m} \times N$, where N is the number of connected devices (including controller). In any case, do not construct a system whose total cable length exceeds 20 m.
- Do not connect any single device with more than four connectors. Doing so exposes the connectors to excessive strain, possibly causing a failure.
- The topology of device connections can be star, linear, or a combination of them. Loop connections are not supported.

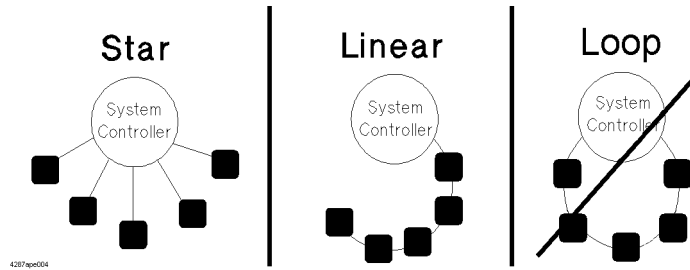





Device selector

Each device is assigned a unique identifier called the “device selector.” When the controller attempts to control (communicate messages with) one of the devices connected over the GPIB remote control system, it selects that device with the appropriate device selector.

A device selector consists of a select code (normally 7) and a GPIB address. For example, when the select code is 7 and the GPIB address is 17, the device selector is 717. The select code is system-global. Each device in the same system is assigned a GPIB address that uniquely identifies it. When this document refers to a device selector in descriptive text or sample programs, it is always assumed to be 717. Use the following procedure to set the GPIB address of the 4287A.

Setting the GPIB address (17) for the Agilent 4287A

- Step 1.** Press the [System] key on the front panel.
- Step 2.** From the softkey menu along the right-hand edge of the screen, select the softkey labeled **GPIB ADDR [XX]** (where **XX** indicates the current address) by pressing the  or  key. Then, press the  key.
- Step 3.** When you see the GPIB address entry screen, enter the address (17) by pressing **[1]** and **[7]** on the numeric keypad. Then press the **[x1]** key or the  key.

Sending GPIB Command Messages

Types and structure of GPIB commands

GPIB commands available with the 4287A can be divided into two groups:

4287A specific commands

These commands are specific to the 4287A. They provide access to all measurement features and some generic features built into the 4287A. Commands in this group have a hierarchical (multi-level) structure called the “command tree” (see Appendix D, “GPIB Command Tree”). Each command consists of multi-level strings (mnemonics) and colons (:) that delimit the levels of the hierarchy.

IEEE common commands

These are commands that provide access to generic features defined by IEEE488.2. They are accepted by any instrument that complies with IEEE488.2. Each command in this group is prefixed with an asterisk (*). These commands have no hierarchical levels.

Command tree concept

The topmost command in the command tree is referred to as the “root command,” or simply the “root.” To access a lower-level command in the command tree, you must specify the appropriate path, which looks like a directory path in the DOS file system. Turning on the power or resetting the instrument changes the current path to the root. Also, different path settings are used depending on the special symbols contained in messages:

Message terminators

When a message terminator such as <new line> is detected, the current path is set to the root.

Colons (:) When a colon is detected between two command mnemonics, the current path is changed to the next lower level. When a colon is detected at the beginning of a command, the command mnemonic that follows is specified as the root level command.

Semicolons (;) A semicolon is used to delimit two commands contained in the same message without changing the current path.

Figure 2-2 illustrates how colons and semicolons can be used to efficiently access various commands in the command tree.

Figure 2-2

Using colons and semicolons

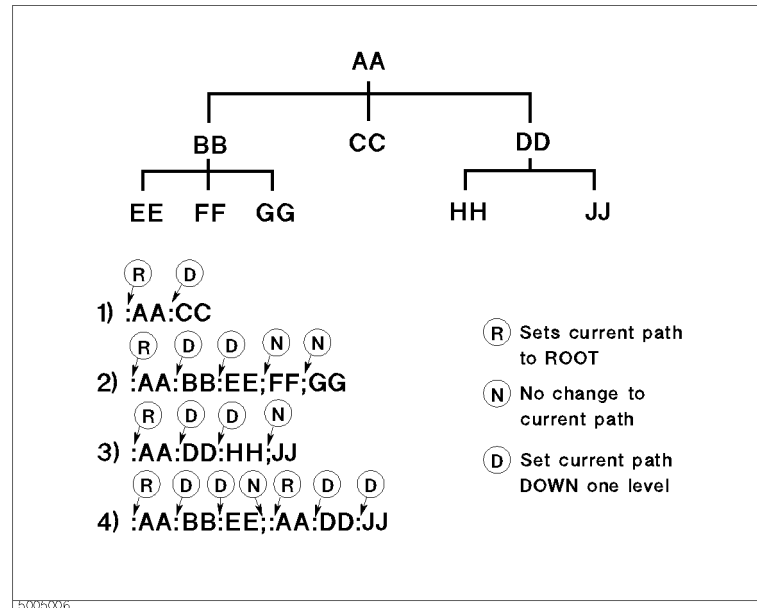

Message syntax

This section describes the syntax for sending program messages via GPIB. Program messages are sent by the user from an external controller to the instrument to control the instrument. A program message contains one or more commands along with any required parameters.

Case sensitivity

Program messages are not case sensitive.

Program message terminators

A program message must be terminated with one of three program message terminators: <new line>, <^END>, or <new line><^END>. The <^END> terminator ensures that the immediately preceding data byte is sent out and that EOI is set to the active level on the GPIB interface. For example, the OUTPUT command (HP BASIC) automatically sends a message terminator following the last data byte.

Parameters

You must put a space character (ASCII code 32) between the command and the first parameter. When you send a command with two or more parameters, you must delimit the parameters with commas (.).

Multi-command messages

When you send a message that contains two or more commands, you must delimit the commands with semicolons (;). The following HP BASIC example shows how to send a message that contains *CLS and :INIT commands.

```
OUTPUT 717; " *CLS; :INIT"
```

Remote mode

The 4287A does not have a remote mode. Therefore, the 4287A is not automatically set to the remote mode when it receives a GPIB command. Furthermore, there is no local key to clear the remote mode on the 4287A's front panel.

Use the key lock function to prevent mis-input from the front panel keys. To lock the front panel, the keyboard or the mouse, use the following commands.

- :SYST:KLOC on page 299
- :SYST:KLOC:KBD on page 299
- :SYST:KLOC:MOUS on page 300

3

Specifying Measurement Conditions

This chapter explains how to set measurement conditions and configure the instrument's display of measurement results.

Setting Measurement Parameters

You can assign measurement parameters 1 through 4 (:PAR1, :PAR2, :PAR3, and :PAR4) independently of the other parameter settings. To set measurement parameters, use the following command:

- :CALC:PAR{1-4}:FORM on page 224

You can configure the instrument to measure the parameters shown in the table below:

Parameter	Parameter label on screen	Description
Z	Z	Impedance amplitude (absolute value)
Y	Y	Admittance amplitude (absolute value)
LS	Ls	Equivalent series inductance
LP	Lp	Equivalent parallel inductance
CS	Cs	Equivalent series capacitance
CP	Cp	Equivalent parallel capacitance
RS	Rs	Equivalent series resistance
RP	Rp	Equivalent parallel resistance
Q	Q	Q value (inverse of dissipation factor)
D	D	Dissipation factor
X	X	Equivalent series reactance
G	G	Equivalent parallel conductance
B	B	Equivalent parallel susceptance
TZR	θ_z (rad)	Impedance phase (in radians)
TZD	θ_z (deg)	Impedance phase (in degrees)
TYR	θ_y (rad)	Admittance phase (in radians)
TYD	θ_y (deg)	Admittance phase (in degrees)

Setting Measurement Point Setup Tables (Signal Source and Averaging Factor)

You can use up to eight measurement point setup tables (Tables 1 through 8) to define the signal source frequency and averaging factor for each measurement point. Each measurement point setup table can contain up to 32 measurement points.

When you set measurement points, new settings are applied to the active table. To configure the active table, use the following command:

- `:SOUR:LIST:TABL` on page 291

When you manually configure a measurement point setup table, you must add each measurement point to the table and define the various conditions that apply to the specific measurement point. On the other hand, when you use an external controller to configure a measurement point setup table, you can use the following command to define all the measurement points in the active table at once:

- `:SOUR:LIST` on page 288

You can use the following command to set the unit for the signal source level:

- `:SOUR:UNIT` on page 292

To change only the averaging factor after completion of calibration/compensation, you may execute the `:SOUR:LIST` command by specifying the parameter so that only the averaging factor will change with the frequency and signal source level identical to the current settings. In this case, calibration and compensation will be turned off automatically; you will need to rerun calibration and compensation.

If you need to change only the averaging factor after completion of calibration or compensation, use the following command:

- `:AVER:COUN` on page 204

Execution of the `:AVER:COUN` command does not turn off calibration or compensation automatically.

To delete all entries from each table, issue the following command:

- `:SOUR:LIST:CLE` on page 289

NOTE

Issuing this command initializes all of the tables (Tables 1 through 8), regardless of which table is currently active.

To check the number of measurement points defined in the active table, use the following command:

- `:SOUR:LIST:SIZE?` on page 290

Choosing Whether to Measure the DUT at a Single Point or Multiple Points

Before starting a measurement session with the 4287A, you need to choose whether to measure the DUT at all points defined in the table or at a single point, that is, list measurement versus single-point measurement. To make this selection, use the following command:

- :SOUR:LIST:STAT on page 291

When you choose single-point measurement, you must specify the measurement point, which must be one of the measurement points defined in the active table. To specify the single measurement point, use the following command:

- :SOUR:LIST:POIN on page 289
-

Configuring the Instrument for R_{dc} Measurement

Turning on/off the R_{dc} measurement function

To specify whether to perform R_{dc} measurement, use the following command:

- :SOUR:LIST:RDC on page 290

When the bin sorting function is enabled, turning on R_{dc} measurement enables the test function that determines whether the result of R_{dc} measurement falls within the limit range.

Turning on/off the offset cancel function

You can instruct the instrument to turn on or off the offset cancel function by using the following command:

- :SOUR:LIST:RDC:OFSC on page 290

NOTE

To use the offset cancel function, turn ON the offset cancel function before measuring calibration/compensation data.

Setting the limit range for R_{dc} measurement

To set a limit range for R_{dc} measurement, use the following command:

- :CALC:COMP:RDC:LIM on page 218

Setting How the Instrument Displays Measurement Results (Enabling/Disabling Deviation Measurement Mode)

You can have the instrument display measurement results as absolute values or as deviations relative to the reference value (deviation measurement mode). You can change this setting for each of the measurement parameters 1 through 4 (:PAR1 through :PAR4). To make this selection, use the following command:

- :CALC:PAR{1-4}:EXPR:STAT on page 223

In deviation mode, you can set the instrument to display deviations as they are or as percentages relative to the reference value. To make this selection, use the following command:

- :CALC:PAR{1-4}:EXPR:NAME on page 223

To set the reference value for deviation mode, use the following command:

- :CALC:PAR{1-4}:EXPR:CENT on page 222

How the instrument displays measurement results differs according to the settings made with the above two commands, as summarized in the table below.

Setting with the :CALC:PAR{1-4}:EXPR:STAT command	OFF or 0	ON or 1	
Setting with the :CALC:PAR{1-4}:EXPR:NAME command	——	DEV	PCNT
How measurement results are displayed	<i>Meas</i>	<i>Meas - Ref</i>	$\frac{Meas - Ref}{Ref} \times 100$

where *Meas* and *Ref* mean the following:

Meas : Measured value

Ref : Reference value (set with the :CALC:PAR{1-4}:EXPR:CENT command)

NOTE

When you use a GIPB command, such as the :FETC? command on page 274, to retrieve measurement values, the above settings are applied to the values displayed on screen.

When you are testing DUTs while using the bin sorting function, the instrument always displays measurement results as they are, regardless of the above settings. See Figure 6-5, “4287A’s data processing flow,” on page 77.

Configuring Screen Display

Configuring the display of measurement results

Showing/hiding all measurement results

You can instruct the instrument to show or hide the entire set of measurement results, which includes the measurement results for measurement parameters 1 through 4, test signal level monitoring, and R_{dc} measurement). To do so, use the following command:

- :DISP:TEXT1 on page 263

Configuring the display of Individual values

You can set the following display attributes for each value:

- Number of digits
- Whether to fix the decimal point
- Most significant digit when the value is displayed with the decimal point fixed
- Whether to show or hide the value

To set the above display attributes, use the commands listed in the table below.

	Results for measurement parameters :CALC1: parameter 1 :CALC2: parameter 2 :CALC3: parameter 3 :CALC4: parameter 4	Result of test signal level monitoring :CALC11: current level :CALC12: voltage level	Result of R_{dc} measurement
Number of digits	:DISP:TEXT1:CALC{1-4}:DIG on page 264	:DISP:TEXT1:CALC{11-12}:DIG on page 266	:DISP:TEXT1:CALC13:DIG on page 268
Whether to fix decimal point	:DISP:TEXT1:CALC{1-4}:FIX on page 265	:DISP:TEXT1:CALC{11-12}:FIX on page 267	:DISP:TEXT1:CALC13:FIX on page 268
Most significant digit when decimal point is fixed	:DISP:TEXT1:CALC{1-4}:MSD on page 265	:DISP:TEXT1:CALC{11-12}:MSD on page 267	:DISP:TEXT1:CALC13:MSD on page 269
Whether to show or hide value	:DISP:TEXT1:CALC{1-4} on page 264	:DISP:TEXT1:CALC{11-12} on page 266	:SOUR:LIST:RDC on page 290*1

*1. This command not only sets whether to show or hide the result of R_{dc} measurement but also whether to turn on or off the R_{dc} measurement function. You cannot use the command to only show or hide the R_{dc} result.

Setting the display items on the list measurement screen

To define each of the four display items (:LAB1 through :LAB4) that appear on the list measurement screen, use the following command:

- :DISP:TEXT2:LAB{1-4} on page 272

Turning on/off the display

You can instruct the instrument to show or hide all of the displayed items except the menu bar by using the following command:

- :DISP on page 262

Turning on/off the update of the display

You can instruct the instrument to turn on or off the update of the display by using the following command:

- :DISP:UPD on page 273

The advantage of the off status is that it allows faster processing speeds of GPIB commands than does the on status; on the other hand, its disadvantage is that there is limited update of the items displayed on the screen.

Turning on/off the backlight of the LCD screen

You can instruct the instrument to turn on or off the backlight of the LCD screen by using the following command:

- :DISP:BACK on page 262

If the backlight is off, you cannot read displayed information on the screen.

Showing or hiding the title

To choose whether to show or hide the title display area (the topmost area on the screen), use the following command:

- :DISP:TEXT10 on page 270

To define the title string that appears in the title display area, use the following command:

- :DISP:TEXT10:DATA on page 270

Turning on/off the date display

To choose whether to show or hide the current date and time in the rightmost part of the status display area, use the following command:

- :DISP:TEXT11 on page 271

Also, you can choose whether to automatically update the time display in increments of 1 minute as time elapses or keep the day, hour, and minute set to the date/time when you turned on the display. To make this selection, use the following command:

- :DISP:TEXT11:MODE on page 271

Sample Program

Example 3-1 shows a sample program that demonstrates how to configure measurement conditions. You can find the source file of this program, named setup.bas, on the sample program disk.

This program resets the instrument and then configures it with the following conditions:

- Active table number: 3
- Point number for single-point measurement: 1
- Measurement point setup table:

Point number	Measuring frequency	Averaging factor	Signal source level
1	1 MHz	2	-10 dBm
2	10 MHz	2	-10 dBm
3	100 MHz	2	-10 dBm
4	1 GHz	2	-10 dBm

- Settings of Measurement Parameters 1 through 4:

	Parameter	Display	Deviation mode		
			On/off	How parameter is displayed	Reference value
Measurement parameter 1	Ls	On	On	Percentage	100 nH
Measurement parameter 2	Rs	On	On	Absolute value	100 nH
Measurement parameter 3	Q	On	Off	—	—
Measurement parameter 4	—	Off	—	—	—

- List measurement: On
- Display parameters for list measurement screen
 - Display item 1: Measuring frequency
 - Display item 2: Measurement parameter (Ls)
 - Display item 3: Measurement parameter (Rs)
 - Display item 4: Measurement parameter (Q)
- Result of test signal current level monitoring: On
- Result of test signal voltage level monitoring: On
- R_{dc} measurement: On
- R_{dc} measurement limit range
 - Lower limit: -5Ω
 - Upper limit: 5Ω
- Title display area: On (title: "Example 3-1")
- Time and date display: On (auto update)

The program is described in detail below:

Line 50	Sets the GPIB address.
Lines 70 to 100	Stores the active table number, the point number for single-point measurement, the unit of the signal source level, and the number of measurement points into the Act_tab, Point_no, Unit\$, and Nop variables, respectively.
Lines 110 to 220	Stores the frequency, averaging factor, and signal source level at each point into the Freq(*), Ave(*), and Pow(*) variables, respectively.
Lines 230 to 340	Stores the parameter settings, deviation mode settings, and reference values for measurement parameters 1 through 4 into the Para(*), Dev\$(*), and Cent(*) arrays, respectively.
Line 350	Stores the on/off setting of list measurement into the List\$ variable.
Lines 360 to 390	Stores the parameter selections for display items 1 through 4 on the list measurement screen into the List_lab\$(*) array.
Lines 400 to 410	Stores the on/off settings for the results of test signal current and voltage monitoring into the Imon_disp\$ and Vmon_disp\$ variables.
Lines 420 to 440	Stores the on/off setting of R_{dc} measurement and the upper and lower limits for the R_{dc} measurement limit range into the Rdc\$, Rdc_l_lim, and Rdc_u_lim variables, respectively.
Lines 450 to 470	Stores the on/off setting of the title display, title string, and the setting of the time display into the Title_disp\$, Title\$, and Clock_disp\$ variables, respectively.
Line 490	Resets the instrument.
Lines 530 to 540	Sets the active table number to Act_tab and the unit of the signal source level to Unit\$.
Lines 550 to 590	Configures the measurement point setup table.
Lines 630 to 770	Configures the instrument with the various settings related to measurement parameters 1 through 4.
Lines 810 to 820	Turns on/off list measurement based on List\$ and sets the point number for single-point measurement to Point_no.
Lines 860 to 870	Turns on/off the results of test signal level current and voltage monitoring based on Imon_disp\$ and Vmon_disp\$.
Lines 910 to 920	Turns on/off R_{dc} measurement based on Rdc\$ and set the limit range for R_{dc} measurement to the range between Rdc_l_lim and Rdc_u_lim.
Lines 960 to 970	Configures display items 1 through 4 on the list measurement screen.
Lines 1020 to 1030	Turns on/off the title display based on Title_disp\$ and sets the title to Title\$.
Lines 1070 to 1120	Configures the date and time display.

Specifying Measurement Conditions Sample Program

Example 3-1

Setting Measurement Conditions (setup.bas)

```
10 DIM Unit$(9),List$(9),Rdc$(9),Para$(1:4)(9),Dev$(1:4)(9)
20 DIM List_lab$(1:4)(9),Title$(30),Title_disp$(9),Clock_disp$(9)
30 REAL Freq(1:4),Pow(1:4),Cent(1:4),Rdc_l_lim,Rdc_u_lim
40 INTEGER Ave(1:4),Act_tab,Nop,Point_no,I
50 ASSIGN @Agt4287a TO 717
60 !
70 Act_tab=3 ! Active Table Number: 3
80 Point_no=1 ! Selected Point No.: 1
90 Unit$="DBM" ! Power Level unit: dBm
100 Nop=4 ! Number of Points: 4
110 Freq(1)=1.0E+6 ! Point No.1 Frequency: 1 MHz
120 Ave(1)=2 ! Averaging Factor: 2
130 Pow(1)=-10 ! OSC Level: -10 dBm
140 Freq(2)=1.0E+7 ! Point No.2 Frequency: 10 MHz
150 Ave(2)=2 ! Averaging Factor: 2
160 Pow(2)=-10 ! OSC Level: -10 dBm
170 Freq(3)=1.0E+8 ! Point No.3 Frequency: 100 MHz
180 Ave(3)=2 ! Averaging Factor: 2
190 Pow(3)=-10 ! OSC Level: -10 dBm
200 Freq(4)=1.0E+9 ! Point No.4 Frequency: 1 GHz
210 Ave(4)=2 ! Averaging Factor: 2
220 Pow(4)=-10 ! OSC Level: -10 dBm
230 Para$(1)="LS" ! Measurement Para.1: Ls
240 Para$(2)="RS" ! Parameter Para.2: Rs
250 Para$(3)="Q" ! Para.3: Q
260 Para$(4)="OFF" ! Para.4 Display Off
270 Dev$(1)="PCNT" ! Deviation Mode Para.1: ON (Pcnt)
280 Dev$(2)="DEV" ! Para.2: ON (Dev)
290 Dev$(3)="OFF" ! Para.3: OFF
300 Dev$(4)="OFF" ! Para.4: OFF
310 Cent(1)=1.0E-7 ! Reference Value Para.1: 100 nH
320 Cent(2)=10 ! for Deviation Mode Para.2: 10 ohm
330 Cent(3)=0 ! Para.3: Dummy
340 Cent(4)=0 ! Para.4: Dummy
350 List$="ON" ! List Measurement: ON
360 List_lab$(1)="FREQ" ! Displayed Parameter Label-1: Freq.
370 List_lab$(2)="PAR1" ! for List Measurement Label-2: Para.1
380 List_lab$(3)="PAR2" ! Label-3: Para.2
390 List_lab$(4)="PAR3" ! Label-4: Para.3
400 Imon_disp$="ON" ! Test Signal Current Display: On
410 Vmon_disp$="ON" ! Level Monitor Voltage Display: On
420 Rdc$="ON" ! Rdc Measurement: ON
430 Rdc_l_lim=-5 ! Rdc Measurement Lower Limit: -0.5 ohm
440 Rdc_u_lim=5 ! Comparator Function Upper Limit: +0.5 ohm
450 Title_disp$="ON" ! Title Display Area Display: On
460 Title$="Example 3-1" ! Title: "Example 3-1"
470 Clock_disp$="LIVE" ! Time and Date Display: ON (Live)
480 !
490 OUTPUT @Agt4287a;" :SYST:PRES"
500 !
510 ! Measurement Point Setup Table
520 !
530 OUTPUT @Agt4287a;" :SOUR:LIST:TABL ";Act_tab
540 OUTPUT @Agt4287a;" :SOUR:UNIT "&Unit$
550 OUTPUT @Agt4287a;" :SOUR:LIST ";Nop;" , ";
560 FOR I=1 TO Nop-1
570 OUTPUT @Agt4287a;Freq(I) ; " , ";Ave(I) ; " , ";Pow(I) ; " , ";
580 NEXT I
590 OUTPUT @Agt4287a;Freq(Nop) ; " , ";Ave(Nop) ; " , ";Pow(Nop)
600 !
610 ! Measurement Parameter
```

```

620 !
630 FOR I=1 TO 4
640   IF Para$(I)="OFF" THEN
650     OUTPUT @Agt4287a;":DISP:TEXT1:CALC"&VAL$(I)&" OFF"
660   ELSE
670     OUTPUT @Agt4287a;":DISP:TEXT1:CALC"&VAL$(I)&" ON"
680     OUTPUT @Agt4287a;":CALC:PAR"&VAL$(I)&":FORM "&Para$(I)
690     IF Dev$(I)="OFF" THEN
700       OUTPUT @Agt4287a;":CALC:PAR"&VAL$(I)&":EXPR:STAT OFF"
710     ELSE
720       OUTPUT @Agt4287a;":CALC:PAR"&VAL$(I)&":EXPR:STAT ON"
730       OUTPUT @Agt4287a;":CALC:PAR"&VAL$(I)&":EXPR:NAME "&Dev$(I)
740       OUTPUT @Agt4287a;":CALC:PAR"&VAL$(I)&":EXPR:CENT ";Cent(I)
750     END IF
760   END IF
770 NEXT I
780 !
790 ! Measurement Point(s)
800 !
810 OUTPUT @Agt4287a;":SOUR:LIST:POIN ";Point_no
820 OUTPUT @Agt4287a;":SOUR:LIST:STAT "&List$
830 !
840 ! Test Signal Level Monitor Result Display
850 !
860 OUTPUT @Agt4287a;":DISP:TEXT1:CALC11 "&Imon_disp$
870 OUTPUT @Agt4287a;":DISP:TEXT1:CALC12 "&Vmon_disp$
880 !
890 ! Rdc Measurement
900 !
910 OUTPUT @Agt4287a;":SOUR:LIST:RDC "&Rdc$
920 OUTPUT @Agt4287a;":CALC:COMP:RDC:LIM ";Rdc_l_lim;",";Rdc_u_lim
930 !
940 ! Displayed Parameter in List Measurement Display
950 !
960 FOR I=1 TO 4
970   OUTPUT @Agt4287a;":DISP:TEXT2:LAB"&VAL$(I)&" "&List_lab$(I)
980 NEXT I
990 !
1000 ! Title Display Area
1010 !
1020 OUTPUT @Agt4287a;":DISP:TEXT10 "&Title_disp$
1030 OUTPUT @Agt4287a;":DISP:TEXT10:DATA ""&Title$&""
1040 !
1050 ! Clock (Data/Time) Display
1060 !
1070 IF Clock_disp$="OFF" THEN
1080   OUTPUT @Agt4287a;":DISP:TEXT11 OFF"
1090 ELSE
1100   OUTPUT @Agt4287a;":DISP:TEXT11 ON"
1110   OUTPUT @Agt4287a;":DISP:TEXT11:MODE "&Clock_disp$
1120 END IF
1130 END

```

Specifying Measurement Conditions
Sample Program

4

Preparing for Accurate Measurement

This chapter explains how to carry out calibration, compensation, and test fixture selection (port extension compensation).

Performing Calibration

Setting calibration kit values

You can select either the 4287A option 700 (16195B 7-mm calibration kit) or a user-defined calibration kit. To make this selection, use the following command:

- `:CORR1:CKIT` on page 225

If you opt to use a user-defined calibration kit, you need to specify how you define the calibration kit and then enter the definitions.

Choosing the definition method (fixed or point-by-point)

- `:CORR1:CKIT:LIST` on page 226

Entering definitions

To define the OPEN, SHORT, and LOAD standards, use the commands listed in the table below.

	Impedance value	R_{dc} value	Offset delay time
OPEN	<code>:CORR1:CKIT:STAN1:LIST</code> on page 229	<code>:CORR1:CKIT:STAN1:DC</code> on page 227	<code>:CORR1:CKIT:STAN1:EDEL</code> on page 228
SHORT	<code>:CORR1:CKIT:STAN2:LIST</code> on page 232	<code>:CORR1:CKIT:STAN2:DC</code> on page 230	<code>:CORR1:CKIT:STAN2:EDEL</code> on page 231
LOAD	<code>:CORR1:CKIT:STAN3:LIST</code> on page 236	<code>:CORR1:CKIT:STAN3:DC</code> on page 233	<code>:CORR1:CKIT:STAN3:EDEL</code> on page 234

When you define the impedance value for the LOAD standard, you can choose one of the available parameter types by using the following command:

- `:CORR1:CKIT:STAN3:FORM` on page 235

Measuring data for calculating calibration coefficients and turning on calibration function

To measure the data for calculating the calibration coefficients, use the following command:

- `:CORR1:COLL` on page 238

This command obtains the data needed for calculating the calibration coefficients for both impedance and R_{dc} measurements. If you want to obtain the data for either impedance or R_{dc} measurement alone, use one of the following commands instead:

- `:CORR1:COLL:RF` on page 240
- `:CORR1:COLL:DC` on page 239

NOTE

Issuing the `:CORR1:COLL`, `:CORR1:COLL:RF`, or `:CORR1:COLL:DC` command does not trigger the instrument to begin data measurement. Therefore, unless the trigger source is Internal trigger, you must trigger the instrument after issuing the command.

After obtaining the data for calculating the calibration coefficients for all of the OPEN, SHORT, and LOAD standards (including the data for both impedance and R_{dc} measurements), issue the following command to calculate the calibration coefficients and turn on the calibration function:

- `:CORR1:COLL:SAVE` on page 240

NOTE

You cannot directly turn on or off the calibration function.

Instead, the calibration function is automatically turned on when you issue the **`:CORR1:COLL:SAVE`** command after measuring the data required for calculating the calibration coefficients.

Also, the calibration function is automatically turned off when you reset the instrument with the `:SYST:PRES` command on page 300 or the `*RST` command on page 200 or when you configure the measurement point setup table with the `:SOUR:LIST` command on page 288.

To check whether the calibration function is currently on or off, use the following command:

- `:CORR1?` on page 225

To define the standard values with the commands described so far, follow these steps:

If you use the same standards for both impedance and R_{dc} measurements or you omit R_{dc} measurement:

- Step 1.** Connect the OPEN standard and then issue the **`:CORR1:COLL`** command, which designates “STAN1” as the parameter. If the trigger source is not Internal trigger, you must trigger the instrument after issuing the command. This applies to steps 2 through 4 as well.
- Step 2.** Connect the SHORT standard and then issue the **`:CORR1:COLL`** command, which designates “STAN2” as the parameter.
- Step 3.** Connect the LOAD standard and then issue the **`:CORR1:COLL`** command, which designates “STAN3” as the parameter.
- Step 4.** To measure a low-loss capacitor, connect the low-loss capacitor and then issue the **`:CORR1:COLL`** or **`:CORR1:COLL:RF`** command, which designates “STAN4” as the parameter.
- Step 5.** Issue the **`:CORR1:COLL:SAVE`** command.

If you use different standards for impedance and R_{dc} measurements:

- Step 1.** Connect the OPEN standard for impedance measurement and then issue the **`:CORR1:COLL`** or **`:CORR1:COLL:RF`** command, which designates “STAN1” as the parameter. If the trigger source is not Internal trigger, you must trigger the instrument after issuing the command. This applies to steps 2 through 7 as well.
- Step 2.** Connect the SHORT standard for impedance measurement and then issue the **`:CORR1:COLL`** or **`:CORR1:COLL:RF`** command, which designates “STAN2” as the parameter.
- Step 3.** Connect the LOAD standard for impedance measurement and then issue the **`:CORR1:COLL`** or **`:CORR1:COLL:RF`** command, which designates “STAN3” as the parameter.

Preparing for Accurate Measurement

Performing Calibration

- Step 4.** To measure a low-loss capacitor, connect the low-loss capacitor and then issue the **:CORR1:COLL** or **:CORR1:COLL:RF** command, which designates “STAN4” as the parameter.
- Step 5.** Connect the OPEN standard for R_{dc} measurement and then issue the **:CORR1:COLL:DC** command, which designates “STAN1” as the parameter.
- Step 6.** Connect the SHORT standard for R_{dc} measurement and then issue the **:CORR1:COLL:DC** command, which designates “STAN2” as the parameter.
- Step 7.** Connect the LOAD standard for R_{dc} measurement and then issue the **:CORR1:COLL:DC** command, which designates “STAN3” as the parameter.
- Step 8.** Issue the **:CORR1:COLL:SAVE** command.

Preventing operational errors when measuring data for calculating calibration coefficients

To retrieve each standard’s measurement data for calculating the calibration coefficients for R_{dc} measurement, use the following command:

- **:DATA:RCAD{1-3}?** on page 259

Since this command returns the R_{dc} measurement value for each standard, you can check whether this value is normal (within the limit range) to prevent operational errors (such as connecting the wrong standard) that may arise when measuring the data for calculating the calibration coefficients.

NOTE

The measurement data for the standards cannot be used for evaluating slight differences in measured values because it is raw measurement data that has not been calibrated and may differ from the specification value. For example, when the LOAD standard is an inductor, it exhibits an R_{dc} value quite similar to that of the SHORT standard; you should be careful not to inadvertently interchange the LOAD and SHORT standards because they are difficult to distinguish by their measured values.

The following table provides guidelines for determining the limit range (upper and lower limits) for testing:

	Lower limit (LowerLimit)	Upper limit (UpperLimit)
SHORT	None	$UpperLimit = (Short + Load)/2$
LOAD	$LowerLimit = (Short + Load)/2$	$\frac{1}{UpperLimit} = \left(\frac{1}{Load} + \frac{1}{Open}\right)/2$
OPEN	$\frac{1}{LowerLimit} = \left(\frac{1}{Load} + \frac{1}{Open}\right)/2$	None

In the table above, Short represents the R_{dc} value for the SHORT standard, Load represents the R_{dc} value for the LOAD standard, and Open represents the R_{dc} value for the OPEN standard.

For example, when the LOAD standard is a 50 Ω resistor, the limit ranges for the respective standards should typically be the following:

SHORT standard: 25 Ω or lower

LOAD standard: 25 to 100 Ω
OPEN standard: 100 Ω or higher

NOTE

When you validate the R_{dc} measurement results returned by the `:DATA:RCAD{1-3}?` command, you should use the absolute value for the following reasons.

When you measure the SHORT standard, whose resistance is extremely low (nearly zero) and susceptible to disturbance during measurement, the command may return a small negative R_{dc} value. On the other hand, when you measure the OPEN standard, whose conductance is extremely low (nearly zero) and susceptible to disturbance during measurement, the command may return a large negative R_{dc} value (an inverse to a negative small conductance value).

The measurement data of the respective standards used for calculating the calibration coefficients for impedance measurement are stored in the calibration data array (see “Calibration Data Arrays” on page 80). You can retrieve this data with the following command:

- `:DATA:CAD{1-8}?` on page 253

Note that the command shown above returns raw RF measurement data. Unlike DC measurement, you cannot simply compare the raw RF measurement data with the standard values to detect operational errors that may have occurred when measuring the calibration data.

Saving or recalling calibrated state (retrieving or writing calibration coefficients)

You can retrieve the calibration coefficients and save them to a file. Later, you can retrieve the calibration coefficients from the file and load them into the 4287A to restore the calibrated state at the time you saved the file.

The calibration coefficients for impedance measurement are stored in the calibration coefficient array (see “Calibration Coefficient Arrays” on page 80). To read or write the calibration coefficient array, use the following command:

- `:DATA:CCO{1-6}` on page 254

To read or write the calibration coefficients for R_{dc} measurement, use the following command:

- `:DATA:RCCO{1-3}` on page 259

NOTE

When setting calibration coefficients, note the following:

- To ensure that the instrument will provide correct measurement results, you must configure the instrument to use the same measurement points (point setup table settings) as when you obtained measurement data for calibration and then set all the coefficients.
 - You must turn on the calibration functions before you set the calibration coefficients. To do so, follow the steps shown in “Measuring data for calculating calibration coefficients and turning on calibration function” on page 38 before setting the calibration coefficients. This procedure includes only measuring tentative data and does not require you to connect the standard before issuing the data measurement command.
-

Sample program

Example 4-1 shows a sample program that demonstrates how to obtain the measurement data for calculating the calibration coefficients. You can find the source file of this program, named `calib.bas`, on the sample program disk.

The sample program begins by configuring the measurement point setup table and calibration kit. After measuring the necessary data, it then calculates the calibration coefficients and turns on the calibration function. Finally, it saves the obtained calibration coefficients to a file named `CAL_DATA`.

The program is described in detail below.

- Lines 100 to 110 Sets the GPIB address and select code.
- Line 120 Stores the name of the calibration coefficients file (`CAL_DATA`) into the `File$` variable.
- Line 130 Resets the instrument.
- Line 140 Sets the data transfer format to ASCII.
- Lines 180 to 230 Configures the measurement point setup table as follows:

Point number	Measuring frequency	Averaging factor	Signal source level
1	10 MHz	4	0 dBm
2	100 MHz	4	0 dBm
3	1 GHz	4	0 dBm

- Line 260 Passes control to a subprogram named `Set_cal_kit` to configure the calibration kit.
- Lines 290 to 320 Passes control to a subprogram named `Inp_data`, which prompts the user to enter the limit values for each standard. Then the program stores the R_{dc} measurement lower limit for the OPEN standard into the `Open_l_lim` variable, the R_{dc} measurement upper limit for the SHORT standard into the `Short_u_lim` variable, and the R_{dc} measurement lower and upper limits for the LOAD standard into the `Load_l_lim` and `Load_u_lim` variables, respectively.
- Lines 350 to 420 Passes control to a subprogram named `FNCal`, which measures the data for OPEN, SHORT, and LOAD standard.
- Lines 440 to 450 Prompts the user to confirm whether to measure a low-loss capacitor and waits until the user presses the y or n key.
- Lines 460 to 490 If the user presses the y key in response to line 450, the program passes control to the `FNCal` subprogram to obtain the measurement data for the low-loss capacitor.
- Lines 420 to 440 Calculates the calibration coefficients and turns on the calibration function.
- Lines 570 to 610 Retrieves the number of measurement points and resizes the arrays `Cal_coef_a1`, `Cal_coef_a2`, `Cal_coef_b1`, `Cal_coef_b2`, `Cal_coef_c1`, and `Cal_coef_c2` accordingly.

- Lines 630 to 740 Retrieves the calibration coefficients for impedance measurement, A1, B1, C1, A2, B2, and C2, and then stores them into the arrays Cal_coef_a1, Cal_coef_b1, Cal_coef_c1, Cal_coef_a2, Cal_coef_b2, and Cal_coef_c2, respectively.
- Lines 760 to 810 Retrieves the calibration coefficients for R_{dc} measurement, A, B, and C, and then stores them into the Cal_coef_dc array, retaining the original order.
- Lines 860 to 880 If File\$ matches the name of an existing file, deletes the file.
- Lines 890 to 920 Creates a new file using the file name identified by the File\$ variable and saves the data from the arrays Cal_coef_a1, Cal_coef_b1, Cal_coef_c1, Cal_coef_a2, Cal_coef_b2, Cal_coef_c2, and Cal_coef_dc to the new file.
- Lines 940 to 970 Terminates program after displaying a closing message along with the name of the file that contains the calibration coefficients.
- The FNCal subprogram in lines 1010 to 1680, which measures the data for calculating the calibration coefficients, is described below.
- Lines 1050 to 1060 Retrieves the current trigger source setting and stores the setting into the Trig_sour\$ variable.
- Lines 1070 to 1090 After measurement is stopped (the trigger system is stopped), the program sets the trigger source to GPIB/LAN trigger and turns on the continuous activation of the trigger system.
- Lines 1100 to 1130 Configures the instrument to generate an SRQ upon completion of measurement.
- Lines 1150 to 1160 Prompts the user to set up the connection for measuring the standard identified by Standard\$ and waits until the user presses the y key followed by the return key.
- Lines 1180 to 1200 Clears the status byte register and operation status event register.
- Lines 1210 to 1220 Sets the branch target for an SRQ interrupt to enable SRQ interrupts.
- Lines 1230 to 1320 Sends the commands to measure the standard identified by Standard\$.
- Lines 1330 to 1350 Triggers the instrument and waits until the measurement cycle finishes.
- Line 1370 Sets the Err_flag variable to 0.
- Lines 1380 to 1540 When the standard is OPEN, SHORT, or LOAD, the subprogram checks whether the R_{dc} value falls within the limit range. If the limit range is exceeded, it sets the Err_flag variable to 1.
- Line 1560 If Err_flag is 0, which means that the R_{dc} value is within the limit range, the subprogram notifies the user of successful measurement.
- Lines 1580 to 1590 If Err_flag is 1, which means that the R_{dc} value is not within the limit range, the subprogram notifies the user of failed measurement and returns to the line where it starts measuring the standard.
- Lines 1610 to 1620 Finally, the subprogram returns 0 after restoring the original trigger source by changing the trigger source to Trig_sour\$.
- Lines 1640 to 1660 If the key the user pressed in line 1160 is not the y key, this statement block is executed and the subprogram returns -1.

Preparing for Accurate Measurement

Performing Calibration

The Set_cal_kit subprogram in lines 1720 to 2750, which configures the calibration kit, is described below.

- Line 1790 Allows the user to return to the entry start line and re-enter the data if an error (such as an invalid entry) occurs while entering the number that identifies the calibration kit.
- Lines 1810 to 1840 Displays the list of supported calibration kits and prompts the user to choose one of the items by typing in the appropriate number.
- Line 1850 Converts the entered value into an integer and stores it into the Kit variable.
- Line 1860 If Kit is neither 1 nor 2, the program returns to the entry start line.
- Line 1900 If Kit is 1, the program configures the instrument to use the 7 mm calibration kit.
- Line 1920 If Kit is 2, the program configures the instrument to use a user-defined calibration kit. The description below assumes that Kit is 2.
- Lines 1940 to 2020 Displays the list of modes for defining the calibration kit and prompts the user to choose one of the items by typing in the appropriate number. Then the program converts the entered value into an integer and stores it into the Def variable.
- Lines 2050 to 2060 If Def is 1, the program configures the instrument so that the user can define the calibration kit in fixed mode and stores “1” into the Nop variable, which indicates the number of measurement points that require definitions.
- Lines 2080 to 2100 If Def is 2, the program configures the instrument so that the user can define the calibration kit in point-by-point mode, and then retrieves the number of points and stores the number into the Nop variable.
- Lines 2130 to 2220 Displays the list of parameter types that can be used to define the LOAD standard and prompts the user to choose one of the items by typing in the appropriate number. Then the program converts the entered value into an integer and stores it into the Load_para variable.
- Lines 2230 to 2360 Sets the parameter type for defining the LOAD standard based on Load_para and stores the parameter names into the Para1\$ and Para2\$ variables.
- Lines 2380 to 2510 Iterates the following steps Nop times.
1. Lines 2390 to 2410: If Nop is 2 or greater, the program displays each measurement point that requires a definition.
 2. Lines 2420 to 2470: Passes control to the Inp_data subprogram to acquire the OPEN, SHORT, or LOAD standard values from user input.
 3. Lines 2480 to 2500: Configures each standard with the entered values.
- Lines 2530 to 2540 Prompts the user to confirm whether to define the standards for R_{dc} measurement and waits until the user presses the y or n key.
- Lines 2550 to 2620 If the user presses the y key in response to line 2540, the program acquires the definitions for R_{dc} measurement from user input and configures the standards accordingly.

Lines 2640 to 2650 Prompts the user to confirm whether to define the delay time and waits until the user presses the y or n key.

Lines 2660 to 2730 If the user presses the y key in response to line 2650, the program acquires the delay time from user input and configures the standards accordingly.

The Inp_data subprogram in lines 2790 to 2900, which lets the user enter the necessary data, is described below.

Line 2810 Returns to the start line of input if an error occurs due to an invalid entry or similar reason. This allows the user to make an entry again.

Lines 2830 to 2840 Prompts the user to enter a data value specified by Mes\$ and waits until the user actually enters the value.

Lines 2860 to 2870 Displays the value entered and waits until the user confirms the entry by pressing the y or n key.

Line 2880 Returns to the entry start line if the key the user pressed in line 2870 is not the y key.

Preparing for Accurate Measurement Performing Calibration

Example 4-1

Calibration (calib.bas)

```
10 DIM Buff$(9),File$(20),Inp_char$(9)
20 DIM Cal_coef_a1(1:32,1:2),Cal_coef_a2(1:32,1:2)
30 DIM Cal_coef_b1(1:32,1:2),Cal_coef_b2(1:32,1:2)
40 DIM Cal_coef_c1(1:32,1:2),Cal_coef_c2(1:32,1:2)
50 DIM Cal_coef_dc(1:3)
60 REAL Open_l_lim,Short_u_lim,Load_l_lim,Load_u_lim
70 INTEGER Scode,Nop,Result
80 !
90 CLEAR SCREEN
100 ASSIGN @Agt4287a TO 717
110 Scode=7
120 File$="CAL_DATA"
130 OUTPUT @Agt4287a;" :SYST:PRES"
140 OUTPUT @Agt4287a;" :FORM ASC"
150 !-----
160 ! Measurement Point Setup Table Setting
170 !-----
180 OUTPUT @Agt4287a;" :SOUR:LIST:TABL 1"
190 OUTPUT @Agt4287a;" :SOUR:UNIT DBM"
200 OUTPUT @Agt4287a;" :SOUR:LIST 3, ";
210 OUTPUT @Agt4287a;"10E6,4,0, ";
220 OUTPUT @Agt4287a;"100E6,4,0, ";
230 OUTPUT @Agt4287a;"1E9,4,0"
240 !
250 PRINT "## Calibration Kit Setting ##"
260 CALL Set_cal_kit(@Agt4287a)
270 !
280 PRINT "## Rdc Limit Setting ##"
290 CALL Inp_data("Open Lower Limit",Open_l_lim)
300 CALL Inp_data("Short Upper Limit",Short_u_lim)
310 CALL Inp_data("Load Lower Limit",Load_l_lim)
320 CALL Inp_data("Load Upper Limit",Load_u_lim)
330 !
340 PRINT "## Measurement ##"
350 Result=FNCal(@Agt4287a,Scode,"Open",Open_l_lim,1.E+9)
360 IF Result<>0 THEN Prog_end
370 !
380 Result=FNCal(@Agt4287a,Scode,"Short",-1.E+9,Short_u_lim)
390 IF Result<>0 THEN Prog_end
400 !
410 Result=FNCal(@Agt4287a,Scode,"Load",Load_l_lim,Load_u_lim)
420 IF Result<>0 THEN Prog_end
430 !
440 PRINT "Do you want to measure Low Loss Capacitor"
450 INPUT "[Y]es/[N]o",Inp_char$
460 IF UPC$(Inp_char$)="Y" OR UPC$(Inp_char$)="YES" THEN
470     Result=FNCal(@Agt4287a,Scode,"Low Loss C",-1.E+9,1.E+9)
480     IF Result<>0 THEN Prog_end
490 END IF
500 !
510 OUTPUT @Agt4287a;" :CORR1:COLL:SAVE"
520 OUTPUT @Agt4287a;"*OPC?"
530 ENTER @Agt4287a;Buff$
540 !-----
550 ! Calibration Coefficient Array Reading
560 !-----
570 OUTPUT @Agt4287a;" :SOUR:LIST:SIZE?"
580 ENTER @Agt4287a;Nop
590 REDIM Cal_coef_a1(1:Nop,1:2),Cal_coef_a2(1:Nop,1:2)
600 REDIM Cal_coef_b1(1:Nop,1:2),Cal_coef_b2(1:Nop,1:2)
610 REDIM Cal_coef_c1(1:Nop,1:2),Cal_coef_c2(1:Nop,1:2)
```

```

620      !
630      OUTPUT @Agt4287a;" :DATA:CCO1?"
640      ENTER @Agt4287a;Cal_coef_a1(*)
650      OUTPUT @Agt4287a;" :DATA:CCO2?"
660      ENTER @Agt4287a;Cal_coef_b1(*)
670      OUTPUT @Agt4287a;" :DATA:CCO3?"
680      ENTER @Agt4287a;Cal_coef_c1(*)
690      OUTPUT @Agt4287a;" :DATA:CCO4?"
700      ENTER @Agt4287a;Cal_coef_a2(*)
710      OUTPUT @Agt4287a;" :DATA:CCO5?"
720      ENTER @Agt4287a;Cal_coef_b2(*)
730      OUTPUT @Agt4287a;" :DATA:CCO6?"
740      ENTER @Agt4287a;Cal_coef_c2(*)
750      !
760      OUTPUT @Agt4287a;" :DATA:RCCO1?"
770      ENTER @Agt4287a;Cal_coef_dc(1)
780      OUTPUT @Agt4287a;" :DATA:RCCO2?"
790      ENTER @Agt4287a;Cal_coef_dc(2)
800      OUTPUT @Agt4287a;" :DATA:RCCO3?"
810      ENTER @Agt4287a;Cal_coef_dc(3)
820      !-----
830      ! Calibration Coefficient Saving
840      !-----
850      Data_size=(Nop*2*6+3)*8
860      ON ERROR GOTO Skip_purge
870      PURGE File$
880      Skip_purge: OFF ERROR
890      CREATE File$,Data_size
900      ASSIGN @File TO File$;FORMAT OFF
910      OUTPUT @File;Cal_coef_a1(*),Cal_coef_b1(*),Cal_coef_c1(*),
Cal_coef_a2(*),Cal_coef_b2(*),Cal_coef_c2(*),Cal_coef_dc(*)
920      ASSIGN @File TO *
930      !
940      PRINT "## Done ##"
950      PRINT "Save file name: "&File$
960      !
970      Prog_end: END
980      !=====
990      ! Calibration Data Measurement Function
1000     !=====
1010     DEF FNCal(@Agt4287a,INTEGER Scode,Standard$,REAL L_lim,REAL U_lim)
1020     DIM Inp_char$[9],Trig_sour$[9],Buff$[9]
1030     REAL Meas_data
1040     INTEGER Err_flag
1050     OUTPUT @Agt4287a;" :TRIG:SOUR?"
1060     ENTER @Agt4287a;Trig_sour$
1070     OUTPUT @Agt4287a;" :ABOR"
1080     OUTPUT @Agt4287a;" :TRIG:SOUR BUS"
1090     OUTPUT @Agt4287a;" :INIT:CONT ON"
1100     OUTPUT @Agt4287a;" :STAT:OPER:PTR 0"
1110     OUTPUT @Agt4287a;" :STAT:OPER:NTR 16"
1120     OUTPUT @Agt4287a;" :STAT:OPER:ENAB 16"
1130     OUTPUT @Agt4287a;" *SRE 128"
1140     Cal_meas:!
1150     PRINT "Set "&Standard$&"-Connection."
1160     INPUT "OK? [Y/N]",Inp_char$
1170     IF UPC$(Inp_char$)="Y" THEN
1180         OUTPUT @Agt4287a;" *CLS"
1190         OUTPUT @Agt4287a;" *OPC?"
1200         ENTER @Agt4287a;Buff$
1210         ON INTR Scode GOTO Meas_end
1220         ENABLE INTR Scode;2
1230         SELECT Standard$
1240             CASE "Open"

```

Preparing for Accurate Measurement Performing Calibration

```
1250     OUTPUT @Agt4287a;":CORR1:COLL STAN1"
1260     CASE "Short"
1270     OUTPUT @Agt4287a;":CORR1:COLL STAN2"
1280     CASE "Load"
1290     OUTPUT @Agt4287a;":CORR1:COLL STAN3"
1300     CASE "Low Loss C"
1310     OUTPUT @Agt4287a;":CORR1:COLL STAN4"
1320     END SELECT
1330     OUTPUT @Agt4287a;":TRIG"
1340     PRINT "Now measuring..."
1350 Meas_wait: GOTO Meas_wait
1360 Meas_end: OFF INTR Scode
1370     Err_flag=0
1380     SELECT Standard$
1390     CASE "Open"
1400     OUTPUT @Agt4287a;":DATA:RCAD1?"
1410     ENTER @Agt4287a;Rdc
1420     PRINT "Rdc =";ABS(Rdc)
1430     IF ABS(Rdc)<L_lim THEN Err_flag=1
1440     CASE "Short"
1450     OUTPUT @Agt4287a;":DATA:RCAD2?"
1460     ENTER @Agt4287a;Rdc
1470     PRINT "Rdc =";ABS(Rdc)
1480     IF ABS(Rdc)>U_lim THEN Err_flag=1
1490     CASE "Load"
1500     OUTPUT @Agt4287a;":DATA:RCAD3?"
1510     ENTER @Agt4287a;Rdc
1520     PRINT "Rdc =";ABS(Rdc)
1530     IF ABS(Rdc)<L_lim OR ABS(Rdc)>U_lim THEN Err_flag=1
1540     END SELECT
1550     IF Err_flag=0 THEN
1560     PRINT Standard$&" Data Measurement Complete"
1570     ELSE
1580     PRINT "ERROR!!"
1590     GOTO Cal_meas
1600     END IF
1610     OUTPUT @Agt4287a;":TRIG:SOUR "&Trig_sour$
1620     RETURN 0
1630     ELSE
1640     OUTPUT @Agt4287a;":TRIG:SOUR "&Trig_sour$
1650     PRINT "Program Interruption"
1660     RETURN -1
1670     END IF
1680 FNEND
1690 !=====
1700 ! Calibration Kit Setup Function
1710 !=====
1720 SUB Set_cal_kit(@Agt4287a)
1730 DIM Inp_char$(9),Para1$(9),Para2$(9)
1740 INTEGER Def,Nop,Load_para,Point
1750 REAL Open1,Open2,Open_dc,Open_del
1760 REAL Shor1,Shor2,Shor_dc,Shor_del
1770 REAL Load1,Load2,Load_dc,Load_del
1780 !
1790 ON ERROR GOTO Kit_select
1800 Kit_select: !
1810 PRINT "Select Calibration Kit"
1820 PRINT " 1: 7 mm Standard"
1830 PRINT " 2: User Defined"
1840 INPUT "Input 1 or 2",Inp_char$
1850 Kit=IVAL(Inp_char$,10)
1860 IF Kit<1 OR Kit>2 THEN Kit_select
1870 OFF ERROR
1880 !
```



```

1890 IF Kit=1 THEN
1900   OUTPUT @Agt4287a;":CORR1:CKIT DEF"
1910 ELSE
1920   OUTPUT @Agt4287a;":CORR1:CKIT USER"
1930   !
1940   ON ERROR GOTO Def_select
1950 Def_select:!
1960   PRINT "Select Definition Type"
1970   PRINT " 1: Fixed"
1980   PRINT " 2: Not Fixed"
1990   INPUT "Input 1 or 2",Inp_char$
2000   Def=IVAL(Inp_char$,10)
2010   IF Def<1 OR Def>2 THEN Def_select
2020   OFF ERROR
2030   SELECT Def
2040     CASE 1
2050       OUTPUT @Agt4287a;":CORR1:CKIT:LIST OFF"
2060       Nop=1
2070     CASE 2
2080       OUTPUT @Agt4287a;":CORR1:CKIT:LIST ON"
2090       OUTPUT @Agt4287a;":SOUR:LIST:SIZE?"
2100       ENTER @Agt4287a;Nop
2110   END SELECT
2120   !
2130   ON ERROR GOTO Load_select
2140 Load_select:!
2150   PRINT "Select Load Definition Parameters"
2160   PRINT " 1: Rs and Ls"
2170   PRINT " 2: Ls and Q"
2180   PRINT " 3: Cp and D"
2190   INPUT "Input 1 to 3",Inp_char$
2200   Load_para=IVAL(Inp_char$,10)
2210   IF Load_para<1 OR Load_para>3 THEN Load_select
2220   OFF ERROR
2230   SELECT Load_para
2240     CASE 1
2250       OUTPUT @Agt4287a;":CORR1:CKIT:STAN3:FORM RL"
2260       Para1$="Rs"
2270       Para2$="Ls"
2280     CASE 2
2290       OUTPUT @Agt4287a;":CORR1:CKIT:STAN3:FORM LQF"
2300       Para1$="Ls"
2310       Para2$="Q"
2320     CASE 3
2330       OUTPUT @Agt4287a;":CORR1:CKIT:STAN3:FORM CDF"
2340       Para1$="Cp"
2350       Para2$="D"
2360   END SELECT
2370   !
2380   FOR Point=1 TO Nop
2390     IF Nop>1 THEN
2400       PRINT "[Point No."&VAL$(Point)&"]"
2410     END IF
2420     CALL Inp_data("Open(G) Value",Open1)
2430     CALL Inp_data("Open(Cp) Value",Open2)
2440     CALL Inp_data("Short(Rs) Value",Shor1)
2450     CALL Inp_data("Short(Ls) Value",Shor2)
2460     CALL Inp_data("Load("&Para1$&") Value",Load1)
2470     CALL Inp_data("Load("&Para2$&") Value",Load2)
2480     OUTPUT @Agt4287a;":CORR1:CKIT:STAN1:LIST ";Point;",";Open1;","
;Open2
2490     OUTPUT @Agt4287a;":CORR1:CKIT:STAN2:LIST ";Point;",";Shor1;","
;Shor2
2500     OUTPUT @Agt4287a;":CORR1:CKIT:STAN3:LIST ";Point;",";Load1;","

```

Preparing for Accurate Measurement Performing Calibration

```
;Load2
2510     NEXT Point
2520     !
2530     PRINT "Do you want to define standard values for Rdc measurement?"
2540     INPUT "[Y]es/[N]o", Inp_char$
2550     IF UPC$(Inp_char$)="Y" OR UPC$(Inp_char$)="YES" THEN
2560         CALL Inp_data("Open(G) Value for Rdc Measurement",Open_dc)
2570         CALL Inp_data("Short(R) Value for Rdc Measurement",Shor_dc)
2580         CALL Inp_data("Load(R) Value for Rdc Measurement",Load_dc)
2590         OUTPUT @Agt4287a;":CORR1:CKIT:STAN1:DC ";Open_dc
2600         OUTPUT @Agt4287a;":CORR1:CKIT:STAN2:DC ";Shor_dc
2610         OUTPUT @Agt4287a;":CORR1:CKIT:STAN3:DC ";Load_dc
2620     END IF
2630     !
2640     PRINT "Do you want to define standard delay values?"
2650     INPUT "[Y]es/[N]o", Inp_char$
2660     IF UPC$(Inp_char$)="Y" OR UPC$(Inp_char$)="YES" THEN
2670         CALL Inp_data("Open Delay Time",Open_del)
2680         CALL Inp_data("Short Delay Time",Shor_del)
2690         CALL Inp_data("Load Delay Time",Load_del)
2700         OUTPUT @Agt4287a;":CORR1:CKIT:STAN1:EDEL ";Open_del
2710         OUTPUT @Agt4287a;":CORR1:CKIT:STAN2:EDEL ";Shor_del
2720         OUTPUT @Agt4287a;":CORR1:CKIT:STAN3:EDEL ";Load_del
2730     END IF
2740     END IF
2750     SUBEND
2760     !=====
2770     ! Data Input Function
2780     !=====
2790     SUB Inp_data(Mes$,Inp_val)
2800         DIM Inp_char$(30)
2810         ON ERROR GOTO Inp_start
2820         Inp_start: !
2830         PRINT "Input "&Mes$
2840         INPUT "Value?", Inp_char$
2850         Inp_val=VAL(UPC$(Inp_char$))
2860         PRINT "Input Value: ";Inp_val
2870         INPUT "OK? [Y/N]", Inp_char$
2880         IF UPC$(Inp_char$)<>"Y" THEN Inp_start
2890         OFF ERROR
2900     SUBEND
```

Selecting a Test Fixture (Port Extension Compensation)

Using port extension compensation function

To compensate for the delay due to the test fixture that holds the DUT (port extension compensation), you must tell the instrument which test fixture is used in your measurement. This can be done by selecting data for electrical length compensation, which is predefined and specific to each test fixture. To specify the test fixture, use the following command:

- :CORR2:FIXT on page 250

NOTE

Before running the compensation process, you must specify the fixture or, if using a custom fixture, set the compensation values for the fixture.

Configuring the instrument to use your custom test fixture

When you use a custom test fixture, you must set the compensation value for the delay due to the fixture's electrical length. In addition, you can optionally specify the fixture's name.

To set the compensation value for the delay due to the fixture's electrical length, use the following command:

- :CORR2:FIXT:EDEL:DIST on page 251

If you opt to specify the fixture's name so that it will be shown on the selection screen when selecting the test fixture, use the following command:

- :CORR2:FIXT:LAB on page 252

Running the Compensation Process

NOTE

You must turn on the calibration function before using it. In other words, when the calibration function is off, you cannot perform any of the compensation related operations, including measuring the data for calculating the compensation coefficients, calculating the compensation coefficients, turning on or off the compensation function, and retrieving or setting the compensation coefficients. However, you can configure the compensation kit even when the calibration function is off.

Setting compensation kit values

You can either use the 4287A's predefined compensation kit values or directly enter other compensation kit values. To choose how the compensation kit values are defined, use the following command:

- `:CORR2:CKIT` on page 241

If you opt to enter the values, you need to specify how the compensation kit itself is defined and then enter the definitions.

Choosing definition method (Fixed or Point-by-Point)

- `:CORR2:CKIT:LIST` on page 241

Entering definitions

To define the OPEN and SHORT standards, use the commands listed in the following table:

	Impedance value	R_{dc} value
OPEN	<code>:CORR2:CKIT:STAN1:LIST</code> on page 243	<code>:CORR2:CKIT:STAN1:DC</code> on page 242
SHORT	<code>:CORR2:CKIT:STAN2:LIST</code> on page 245	<code>:CORR2:CKIT:STAN2:DC</code> on page 244

Measuring data for calculating compensation coefficients

To measure the data for calculating the compensation coefficients, use the following command:

- `:CORR2:COLL` on page 246

The command shown above returns the data for calculating the compensation coefficients for both impedance and R_{dc} measurements. If you want to obtain the data for either impedance or R_{dc} measurement alone, use one of the following commands instead:

- `:CORR2:COLL:RF` on page 248
- `:CORR2:COLL:DC` on page 247

NOTE

Issuing the `:CORR2:COLL`, `:CORR2:COLL:RF`, or `:CORR2:COLL:DC` command does not trigger the instrument to begin measuring the data. This means that if the trigger

source is not Internal trigger, you must trigger the instrument after issuing the command.

To define the OPEN and SHORT compensation standards using the commands described so far, follow these steps:

If you use the same standards for both impedance and R_{dc} measurements or you omit R_{dc} measurement:

- Step 1.** Connect the OPEN standard and then issue the **:CORR2:COLL** command, which designates “STAN1” as the parameter. If the trigger source is not Internal trigger, you must trigger the instrument after issuing the command. This applies to step 2 as well.
- Step 2.** Connect the SHORT standard and then issue the **:CORR2:COLL** command, which designates “STAN2” as the parameter.
- Step 3.** Issue the **:CORR2:COLL:SAVE** command.

If you use different standards for impedance and R_{dc} measurements:

- Step 1.** Connect the OPEN standard for impedance measurement and then issue the **:CORR2:COLL** or **:CORR2:COLL:RF** command, which designates “STAN1” as the parameter. If the trigger source is not Internal trigger, you must trigger the instrument after issuing the command. This applies to steps 2 through 4 as well.
- Step 2.** Connect the SHORT standard for impedance measurement and then issue the **:CORR2:COLL** or **:CORR2:COLL:RF** command, which designates “STAN2” as the parameter.
- Step 3.** Connect the OPEN standard for R_{dc} measurement and then issue the **:CORR2:COLL:DC** command, which designates “STAN1” as the parameter.
- Step 4.** Connect the SHORT standard for R_{dc} measurement and then issue the **:CORR2:COLL:DC** command, which designates “STAN2” as the parameter.
- Step 5.** Issue the **:CORR2:COLL:SAVE** command.

Calculating compensation coefficients and turning on/off compensation function

After measuring the data for calculating the compensation coefficients, issue the following commands to calculate the compensation coefficients and turn on the compensation function:

Measured data	GPIB command	Status of compensation function after calculation	
		OPEN	SHORT
OPEN and SHORT	:CORR2:COLL:SAVE on page 249	On	On
	:CORR2:COLL:OPEN on page 248* ¹	On	Unchanged
	:CORR2:COLL:SHOR on page 249* ¹	Unchanged	On
OPEN only	:CORR2:COLL:SAVE on page 249	On	Off
	:CORR2:COLL:OPEN on page 248* ¹	On	Off
	:CORR2:COLL:SHOR on page 249	Not supported	
SHORT only	:CORR2:COLL:SAVE on page 249	Off	On
	:CORR2:COLL:OPEN on page 248	Not supported	
	:CORR2:COLL:SHOR on page 249* ¹	Off	On

*1. Issue the command, which designates “ON” (or “1”) as the parameter.

When the OPEN compensation function is currently on, you can issue the **:CORR2:COLL:OPEN** command by specifying “OFF” (or “0”) as the parameter to turn off the OPEN compensation function.

Similarly, when the SHORT compensation function is currently on, you can issue the **:CORR2:COLL:SHOR** command by specifying “OFF” (or “0”) as the parameter to turn off the SHORT compensation function.

Preventing operational errors when measuring data for calculating compensation coefficients

To retrieve each standard’s measurement data for calculating the compensation coefficients for R_{dc} measurement, use the following command:

- :DATA:RCMD{1-2}? on page 260

Since this command returns the R_{dc} measurement value (without compensation) for each of the OPEN and SHORT standards, you can check whether this value is normal to prevent operational errors (such as connecting the wrong standard) that may arise when measuring the data.

NOTE

When you validate the R_{dc} measurement results returned by the command :DATA:RCMD{1-2}? on page 260, you should use the absolute value for the same reasons as shown in “Preventing operational errors when measuring data for calculating calibration coefficients” on page 40.

The measurement data of the OPEN and SHORT standards used for calculating the compensation coefficients for impedance measurement are stored in the calibration data array (see “Compensation Data Arrays” on page 81). You can retrieve this data with the following command:

- `:DATA:CMD{1-2}?` on page 255

This command returns RF measurement data without compensation, which require more complex handling than R_{dc} values. To detect operational errors that may have occurred while measuring the compensation data, it is best to use R_{dc} values instead.

Saving or recalling compensated state (retrieving or writing compensation coefficients)

You can retrieve the compensation coefficients and save them to a file. Later, you can retrieve the compensation coefficients from the file and load them into the 4287A to restore the compensated state at the time you saved the file.

The compensation coefficients for impedance measurement are stored in the compensation coefficient array (see “Compensation Coefficient Arrays” on page 81). To read or write the compensation coefficient array, use the following command:

- `:DATA:CMF{1-3}` on page 256

To read or write the compensation coefficients for R_{dc} measurement, use the following command:

- `:DATA:RCMP{1-3}` on page 260

NOTE

When setting compensation coefficients, note these precautions:

- To ensure that the instrument will provide correct measurement results, you must configure the instrument to use the same measurement points (point setup table settings) as when you obtained measurement data for compensation and turn on the calibration function before you set the coefficients.
 - You must turn on the compensation function before setting the compensation coefficients. To do so, follow the steps shown in “Measuring data for calculating compensation coefficients” on page 52. This procedure includes only measuring tentative data, and does not require you to connect the standard before issuing the data measurement command.
-

Sample program

Example 4-2 shows a sample program that demonstrates how to obtain the measurement data for calculating the compensation coefficients. You can find the source file of this program, named `compen.bas`, on the sample program disk.

The sample program begins by configuring the measurement point setup table, retrieving the calibration coefficients determined in Example 4-1 from the file, and configuring the instrument accordingly. It lets the user select a test fixture and configure the compensation kit. Finally, it measures the data for calculating the compensation coefficients.

The program is described in detail below.

- Lines 100 to 110 Sets the GPIB address and select code.
- Line 120 Stores the name of the calibration coefficients file (`CAL_DATA`) into the `File$` variable.
- Lines 130 to 140 Stores the R_{dc} measurement lower limit for the OPEN standard ($100\ \Omega$) into the `Open_l_lim` variable and the R_{dc} measurement upper limit for the SHORT standard ($25\ \Omega$) into the `Short_u_lim` variable.
- Line 150 Resets the instrument.
- Line 160 Sets the data transfer format to ASCII.
- Lines 200 to 250 Configures the measurement point setup table as shown below (with the same settings as Example 4-1).

Point number	Measuring frequency	Averaging factor	Signal source level
1	10 MHz	4	0 dBm
2	100 MHz	4	0 dBm
3	1 GHz	4	0 dBm

- Lines 290 to 500 Turns on the calibration function by issuing two commands in sequence to obtain the calibration data and then calculate the calibration coefficients. The calibration coefficients acquired here will be used to overwrite those retrieved from the file (lines 680 to 770) but will not be used for measurement.
- Lines 540 to 580 Retrieves the number of measurement points and resizes the arrays `Cal_coef_a1`, `Cal_coef_a2`, `Cal_coef_b1`, `Cal_coef_b2`, `Cal_coef_c1`, and `Cal_coef_c2` accordingly.
- Line 620 Points to the statement block to be executed if an error occurs in retrieving the calibration coefficients from the file (for example, if no file matches `File$`).
- Lines 630 to 650 Retrieves the calibration coefficients for impedance measurement, `A1`, `B1`, `C1`, `A2`, `B2`, and `C2`, as well as those for R_{dc} measurement, and then stores them into the arrays `Cal_coef_a1`, `Cal_coef_b1`, `Cal_coef_c1`, `Cal_coef_a2`, `Cal_coef_b2`, `Cal_coef_c2`, and `Cal_coef_dc`, respectively.
- Lines 680 to 770 Sets the calibration coefficients.
- Line 820 Passes control to a subprogram named `Set_fixture`, which configures

- the test fixture.
- Line 850 Passes control to a subprogram named Set_comp_kit to configure the compensation kit.
- Lines 880 to 920 Passes control to a subprogram named FNCompen, which measures the OPEN and SHORT data.
- Lines 940 to 960 Calculates the compensation coefficients and turns on the compensation function.
- Line 980 Displays a closing message.
- Lines 1020 to 1050 This statement block is executed if an error occurs in retrieving the calibration coefficients from the file.
- The FNCompen subprogram in lines 1110 to 1690, which measures the data for calculating the compensation coefficients, is described below.
- Lines 1150 to 1160 Retrieves the current trigger source setting, and stores the setting into the Trig_sour\$ variable.
- Lines 1170 to 1190 After measurement is stopped (the trigger system is stopped), sets the trigger source to GPIB/LAN trigger and turns on the continuous activation of the trigger system.
- Lines 1200 to 1230 Configures the instrument to generate an SRQ upon completion of measurement.
- Lines 1250 to 1260 Prompts the user to set up the connection for measuring the standard identified by Standard\$ and waits until the user presses the y key followed by the return key.
- Lines 1280 to 1300 Clears the status byte register and operation status event register.
- Lines 1310 to 1320 Sets the branch target for an SRQ interrupt to enable SRQ interrupts.
- Lines 1330 to 1380 Sends the commands that measure the standard identified by Standard\$.
- Lines 1390 to 1410 Triggers the instrument, and waits until the measurement cycle finishes.
- Line 1430 Sets the Err_flag variable to 0.
- Lines 1440 to 1550 Checks whether the R_{dc} value falls within the limit range. If the limit range is exceeded, it sets the Err_flag variable to 1 again.
- Line 1570 If Err_flag is 0, which means that the R_{dc} value is within the limit range, the subprogram notifies the user of successful measurement.
- Lines 1590 to 1600 If Err_flag is 1, which means that the R_{dc} value is not within the limit range, the subprogram notifies the user of failed measurement and returns to the line where it starts measuring the standard.
- Lines 1620 to 1630 Finally, The subprogram returns 0 after restoring the original trigger source by changing the trigger source to Trig_sour\$.
- Lines 1650 to 1670 If the key the user pressed in line 1260 is not the y key, this statement block is executed and the subprogram returns -1.

Preparing for Accurate Measurement

Running the Compensation Process

The Set_comp_kit subprogram in lines 1730 to 2350, which configures the compensation kit, is described below.

- Line 1790 Allows the user to return to the entry start line and re-enter the data if an error (such as an invalid entry) occurs while entering the number that identifies the calibration kit definitions (4287A's predefined values or custom settings).
- Lines 1810 to 1840 Displays the list of compensation kit definitions and prompts the user to choose one of the items by typing in the appropriate number.
- Line 1850 Converts the entered value into an integer and stores it into the Kit variable.
- Line 1860 If Kit is neither 1 nor 2, the program returns to the entry start line.
- Line 1900 If Kit is 1, the subprogram configures the 4287A to use its built-in definition for the compensation kit values.
- Line 1920 If Kit is 2, the subprogram configures the instrument to use a user-defined compensation kit. The description below assumes that Kit is 2.
- Lines 1940 to 2020 Displays the list of modes for defining the compensation kit and prompts the user to choose one of the items by typing in the appropriate number. Then the program converts the entered value into an integer and stores it into the Def variable.
- Lines 2050 to 2060 If Def is 1, the program configures the instrument so that the user can define the compensation kit in fixed mode and stores "1" into the Nop variable, which indicates the number of measurement points that require definitions.
- Lines 2080 to 2100 If Def is 2, the program configures the instrument so that the user can define the compensation kit in point-by-point mode and then retrieves the number of points and stores the number into the Nop variable.
- Lines 2130 to 2230 Iterates the following steps Nop times.
1. Lines 2140 to 2160: If Nop is 2 or greater, the program displays each measurement point that requires definition.
 2. Lines 2170 to 2200: Passes control to the Inp_data subprogram to acquire the OPEN and standard values from user input.
 3. Lines 2210 to 2220: Configures each standard with the entered values.
- Lines 2250 to 2260 Prompts the user to confirm whether to define the standards for R_{dc} measurement and waits until the user presses the y or n key.
- Lines 2270 to 2320 If the user presses the y key in response to line 2260, the program acquires the definitions for R_{dc} measurement from the user input and configures the standards accordingly.

The Set_fixture subprogram in lines 2390 to 2820, which configures the test fixture, is described below.

- Line 2440 Allows the user to return to the entry start line and re-enter the data if an error (such as an invalid entry) occurs while entering the number that identifies the test fixture.
- Lines 2460 to 2560 Displays the list of supported test fixtures and prompts the user to choose one of the items by typing in the appropriate number.
- Line 2570 Converts the entered value into an integer and stores it into the Fixture variable.
- Line 2580 If Fixture is not an integer between 1 and 9, the program returns to the entry start line.
- Lines 2600 to 2810 Configures the test fixture based on Fixture. If Fixture is 9, which means that the user opted to use a user-defined fixture, the subprogram acquires the delay compensation value (electrical length) from the user input and configures the test fixture accordingly.

For more information on the Inp_data subprogram (lines 2860 to 2970), refer to the description in Example 4-1 on page 46.

Preparing for Accurate Measurement Running the Compensation Process

Example 4-2

Compensation (compen.bas)

```
10 DIM Buff$(9),File$(20),Inp_char$(9)
20 DIM Cal_coef_a1(1:32,1:2),Cal_coef_a2(1:32,1:2)
30 DIM Cal_coef_b1(1:32,1:2),Cal_coef_b2(1:32,1:2)
40 DIM Cal_coef_c1(1:32,1:2),Cal_coef_c2(1:32,1:2)
50 DIM Cal_coef_dc(1:3)
60 REAL Open_l_lim,Short_u_lim
70 INTEGER Scode,Nop,Result,I
80 !
90 CLEAR SCREEN
100 ASSIGN @Agt4287a TO 717
110 Scode=7
120 File$="CAL_DATA"
130 Open_l_lim=100
140 Short_u_lim=25
150 OUTPUT @Agt4287a;":SYST:PRES"
160 OUTPUT @Agt4287a;":FORM ASC"
170 !-----
180 ! Measurement Point Setup Table Setting
190 !-----
200 OUTPUT @Agt4287a;":SOUR:LIST:TABL 1"
210 OUTPUT @Agt4287a;":SOUR:UNIT DBM"
220 OUTPUT @Agt4287a;":SOUR:LIST 3,";
230 OUTPUT @Agt4287a;"10E6,4,0,";
240 OUTPUT @Agt4287a;"100E6,4,0,";
250 OUTPUT @Agt4287a;"1E9,4,0"
260 !-----
270 ! Dummy Measurement
280 !-----
290 OUTPUT @Agt4287a;":ABOR"
300 OUTPUT @Agt4287a;":TRIG:SOUR BUS"
310 OUTPUT @Agt4287a;":INIT:CONT ON"
320 OUTPUT @Agt4287a;":STAT:OPER:PTR 0"
330 OUTPUT @Agt4287a;":STAT:OPER:NTR 16"
340 OUTPUT @Agt4287a;":STAT:OPER:ENAB 16"
350 OUTPUT @Agt4287a;"*SRE 128"
360 FOR I=1 TO 3
370     OUTPUT @Agt4287a;"*CLS"
380     OUTPUT @Agt4287a;"*OPC?"
390     ENTER @Agt4287a;Buff$
400     ON INTR Scode GOTO Dummy_meas_end
410     ENABLE INTR Scode;2
420     OUTPUT @Agt4287a;":CORR1:COLL STAN"&VAL$(I)
430     OUTPUT @Agt4287a;":TRIG"
440 Dummy_meas_wait: GOTO Dummy_meas_wait
450 Dummy_meas_end: OFF INTR Scode
460 NEXT I
470 OUTPUT @Agt4287a;":CORR1:COLL:SAVE"
480 OUTPUT @Agt4287a;"*OPC?"
490 ENTER @Agt4287a;Buff$
500 OUTPUT @Agt4287a;":TRIG:SOUR INT"
510 !-----
520 ! Download Calibration Coeficient
530 !-----
540 OUTPUT @Agt4287a;":SOUR:LIST:SIZE?"
550 ENTER @Agt4287a;Nop
560 REDIM Cal_coef_a1(1:Nop,1:2),Cal_coef_a2(1:Nop,1:2)
570 REDIM Cal_coef_b1(1:Nop,1:2),Cal_coef_b2(1:Nop,1:2)
580 REDIM Cal_coef_c1(1:Nop,1:2),Cal_coef_c2(1:Nop,1:2)
590 !
600 PRINT "Downloading Calibration Coeficient..."
610 !
```

```

620 ON ERROR GOTO File_error
630 ASSIGN @File TO File$
640 ENTER @File;Cal_coef_a1(*),Cal_coef_b1(*),Cal_coef_c1(*),
Cal_coef_a2(*),Cal_coef_b2(*),Cal_coef_c2(*),Cal_coef_dc(*)
650 ASSIGN @File TO *
660 OFF ERROR
670 !
680 OUTPUT @Agt4287a;":DATA:CCO1 ";Cal_coef_a1(*)
690 OUTPUT @Agt4287a;":DATA:CCO2 ";Cal_coef_b1(*)
700 OUTPUT @Agt4287a;":DATA:CCO3 ";Cal_coef_c1(*)
710 OUTPUT @Agt4287a;":DATA:CCO4 ";Cal_coef_a2(*)
720 OUTPUT @Agt4287a;":DATA:CCO5 ";Cal_coef_b2(*)
730 OUTPUT @Agt4287a;":DATA:CCO6 ";Cal_coef_c2(*)
740 !
750 OUTPUT @Agt4287a;":DATA:RCCO1 ";Cal_coef_dc(1)
760 OUTPUT @Agt4287a;":DATA:RCCO2 ";Cal_coef_dc(2)
770 OUTPUT @Agt4287a;":DATA:RCCO3 ";Cal_coef_dc(3)
780 !-----
790 ! Compensation
800 !-----
810 PRINT "## Test Fixture Setting ##"
820 CALL Set_fixture(@Agt4287a)
830 !
840 PRINT "## Compensation Kit Setup ##"
850 CALL Set_comp_kit(@Agt4287a)
860 !
870 PRINT "## Measurement ##"
880 Result=FNCompen(@Agt4287a,Scode,"Open",Open_l_lim)
890 IF Result<>0 THEN Prog_end
900 !
910 Result=FNCompen(@Agt4287a,Scode,"Short",Short_u_lim)
920 IF Result<>0 THEN Prog_end
930 !
940 OUTPUT @Agt4287a;":CORR2:COLL:SAVE"
950 OUTPUT @Agt4287a;":*OPC?"
960 ENTER @Agt4287a;Buff$
970 !
980 PRINT "## Done ##"
990 GOTO Prog_end
1000 !
1010 File_error:OFF ERROR
1020 PRINT "##### ERROR #####"
1030 PRINT "The CAL_DATA (cal. coef. file) is NOT exist."
1040 PRINT " or"
1050 PRINT "The CAL_DATA's size is UNSUITABLE."
1060 !
1070 Prog_end:END
1080 !=====
1090 ! Compensation Data Measurement Function
1100 !=====
1110 DEF FNCompen(@Agt4287a,INTEGER Scode,Standard$,REAL Limit)
1120 DIM Inp_char$(9),Trig_sour$(9),Buff$(9)
1130 REAL Rdc
1140 INTEGER Err_flag
1150 OUTPUT @Agt4287a;":TRIG:SOUR?"
1160 ENTER @Agt4287a;Trig_sour$
1170 OUTPUT @Agt4287a;":ABOR"
1180 OUTPUT @Agt4287a;":TRIG:SOUR BUS"
1190 OUTPUT @Agt4287a;":INIT:CONT ON"
1200 OUTPUT @Agt4287a;":STAT:OPER:PTR 0"
1210 OUTPUT @Agt4287a;":STAT:OPER:NTR 16"
1220 OUTPUT @Agt4287a;":STAT:OPER:ENAB 16"
1230 OUTPUT @Agt4287a;":*SRE 128"
1240 Compen_meas: !

```

Preparing for Accurate Measurement Running the Compensation Process

```
1250 PRINT "Set "&Standard$&"-Connection."
1260 INPUT "OK? [Y/N]",Inp_char$
1270 IF UPC$(Inp_char$)="Y" THEN
1280     OUTPUT @Agt4287a;"*CLS"
1290     OUTPUT @Agt4287a;"*OPC?"
1300     ENTER @Agt4287a;Buff$
1310     ON INTR Scode GOTO Meas_end
1320     ENABLE INTR Scode;2
1330     SELECT Standard$
1340         CASE "Open"
1350             OUTPUT @Agt4287a;":CORR2:COLL STAN1"
1360         CASE "Short"
1370             OUTPUT @Agt4287a;":CORR2:COLL STAN2"
1380     END SELECT
1390     OUTPUT @Agt4287a;":TRIG"
1400     PRINT "Now measuring..."
1410 Meas_wait: GOTO Meas_wait
1420 Meas_end: OFF INTR Scode
1430     Err_flag=0
1440     SELECT Standard$
1450         CASE "Open"
1460             OUTPUT @Agt4287a;":DATA:RCMD1?"
1470             ENTER @Agt4287a;Rdc
1480             PRINT "Rdc =" ;ABS(Rdc)
1490             IF ABS(Rdc)<Limit THEN Err_flag=1
1500         CASE "Short"
1510             OUTPUT @Agt4287a;":DATA:RCMD2?"
1520             ENTER @Agt4287a;Rdc
1530             PRINT "Rdc =" ;ABS(Rdc)
1540             IF ABS(Rdc)>Limit THEN Err_flag=1
1550     END SELECT
1560     IF Err_flag=0 THEN
1570         PRINT Standard$&" Data Measurement Complete"
1580     ELSE
1590         PRINT "ERROR!!"
1600         GOTO Compen_meas
1610     END IF
1620     OUTPUT @Agt4287a;":TRIG:SOUR "&Trig_sour$
1630     RETURN 0
1640 ELSE
1650     OUTPUT @Agt4287a;":TRIG:SOUR "&Trig_sour$
1660     PRINT "Program Interruption"
1670     RETURN -1
1680 END IF
1690 FNEND
1700 !=====
1710 ! Compensation Kit Setup Function
1720 !=====
1730 SUB Set_comp_kit(@Agt4287a)
1740 DIM Inp_char$(30),Para1$(9),Para2$(9)
1750 INTEGER Def,Nop,Load_para,Point
1760 REAL Open1,Open2,Open_dc
1770 REAL Shor1,Shor2,Shor_dc
1780 !
1790 ON ERROR GOTO Kit_select
1800 Kit_select: !
1810 PRINT "Select Compensation Kit Value"
1820 PRINT " 1: Default"
1830 PRINT " 2: User Defined"
1840 INPUT "Input 1 or 2",Inp_char$
1850 Kit=IVAL(Inp_char$,10)
1860 IF Kit<1 OR Kit>2 THEN Kit_select
1870 OFF ERROR
1880 !
```

```

1890 IF Kit=1 THEN
1900   OUTPUT @Agt4287a;":CORR2:CKIT DEF"
1910 ELSE
1920   OUTPUT @Agt4287a;":CORR2:CKIT USER"
1930   !
1940   ON ERROR GOTO Def_select
1950 Def_select: !
1960   PRINT "Select Definition Type"
1970   PRINT " 1: Fixed"
1980   PRINT " 2: Not Fixed"
1990   INPUT "Input 1 or 2",Inp_char$
2000   Def=IVAL(Inp_char$,10)
2010   IF Def<1 OR Def>2 THEN Def_select
2020   OFF ERROR
2030   SELECT Def
2040     CASE 1
2050       OUTPUT @Agt4287a;":CORR2:CKIT:LIST OFF"
2060       Nop=1
2070     CASE 2
2080       OUTPUT @Agt4287a;":CORR2:CKIT:LIST ON"
2090       OUTPUT @Agt4287a;":SOUR:LIST:SIZE?"
2100       ENTER @Agt4287a;Nop
2110   END SELECT
2120   !
2130   FOR Point=1 TO Nop
2140     IF Nop>1 THEN
2150       PRINT "[Point No."&VAL$(Point)&"]"
2160     END IF
2170     CALL Inp_data("Open(G) Value",Open1)
2180     CALL Inp_data("Open(Cp) Value",Open2)
2190     CALL Inp_data("Short(Rs) Value",Shor1)
2200     CALL Inp_data("Short(Ls) Value",Shor2)
2210     OUTPUT @Agt4287a;":CORR2:CKIT:STAN1:LIST ";Point;",";Open1;",";
;Open2
2220     OUTPUT @Agt4287a;":CORR2:CKIT:STAN2:LIST ";Point;",";Shor1;",";
;Shor2
2230   NEXT Point
2240   !
2250   PRINT "Do you want to define standard values for Rdc measurement?"
2260   INPUT "[Y]es/[N]o",Inp_char$
2270   IF UPC$(Inp_char$)="Y" OR UPC$(Inp_char$)="YES" THEN
2280     CALL Inp_data("Open(G) Value for Rdc Measurement",Open_dc)
2290     CALL Inp_data("Short(R) Value for Rdc Measurement",Shor_dc)
2300     OUTPUT @Agt4287a;":CORR2:CKIT:STAN1:DC ";Open_dc
2310     OUTPUT @Agt4287a;":CORR2:CKIT:STAN2:DC ";Shor_dc
2320   END IF
2330 END IF
2340 !
2350 SUBEND
2360 !=====
2370 ! Test Fixture Setting Function
2380 !=====
2390 SUB Set_fixture(@Agt4287a)
2400   DIM Inp_char$(30)
2410   INTEGER Fixture
2420   REAL E_len
2430   !
2440   ON ERROR GOTO Fixture_select
2450 Fixture_select: !
2460   PRINT "Select Test Fixture"
2470   PRINT " 1: None"
2480   PRINT " 2: 16191A"
2490   PRINT " 3: 16192A"
2500   PRINT " 4: 16193A"

```

Preparing for Accurate Measurement Running the Compensation Process

```
2510 PRINT " 5: 16194A"
2520 PRINT " 6: 16196A"
2530 PRINT " 7: 16196B"
2540 PRINT " 8: 16196C"
2550 PRINT " 9: USER"
2560 INPUT "Input 1 to 9",Inp_char$
2570 Fixture=IVAL(Inp_char$,10)
2580 IF Fixture<1 OR Fixture>8 THEN Fixture_select
2590 OFF ERROR
2600 SELECT Fixture
2610     CASE 1
2620         OUTPUT @Agt4287a;":CORR2:FIXT NONE"
2630     CASE 2
2640         OUTPUT @Agt4287a;":CORR2:FIXT FXT16191A"
2650     CASE 3
2660         OUTPUT @Agt4287a;":CORR2:FIXT FXT16192A"
2670     CASE 4
2680         OUTPUT @Agt4287a;":CORR2:FIXT FXT16193A"
2690     CASE 5
2700         OUTPUT @Agt4287a;":CORR2:FIXT FXT16194A"
2710     CASE 6
2720         OUTPUT @Agt4287a;":CORR2:FIXT FXT16196A"
2730     CASE 7
2740         OUTPUT @Agt4287a;":CORR2:FIXT FXT16196B"
2750     CASE 8
2760         OUTPUT @Agt4287a;":CORR2:FIXT FXT16196C"
2770     CASE 9
2780         OUTPUT @Agt4287a;":CORR2:FIXT USER"
2790         CALL Inp_data("Electrical Length of the User Fixture",E_len)
2800         OUTPUT @Agt4287a;":CORR2:FIXT:EDEL:DIST ";E_len
2810     END SELECT
2820 SUBEND
2830 !=====
2840 ! Data Input Function
2850 !=====
2860 SUB Inp_data(Mes$,Inp_val)
2870     DIM Inp_char$(30)
2880     ON ERROR GOTO Inp_start
2890     Inp_start:
2900     PRINT "Input "&Mes$
2910     INPUT "Value?",Inp_char$
2920     Inp_val=VAL(UPC$(Inp_char$))
2930     PRINT "Input Value: ";Inp_val
2940     INPUT "OK? [Y/N]",Inp_char$
2950     IF UPC$(Inp_char$)<>"Y" THEN Inp_start
2960     OFF ERROR
2970 SUBEND
```

5

Starting Measurement Cycle (Triggering) and Detecting End of Measurement

This chapter explains how to trigger the instrument to start a new measurement cycle and how to detect the end of a measurement cycle.

Starting a New Measurement Cycle (Triggering)

Trigger system

The trigger system is responsible for such tasks as detecting the start of a measurement cycle (triggering) and controlling the pre-measurement delay time. As shown in Figure 5-1, the trigger system has three states: Idle, Waiting for Trigger, and Measurement.

Figure 5-1

Trigger system

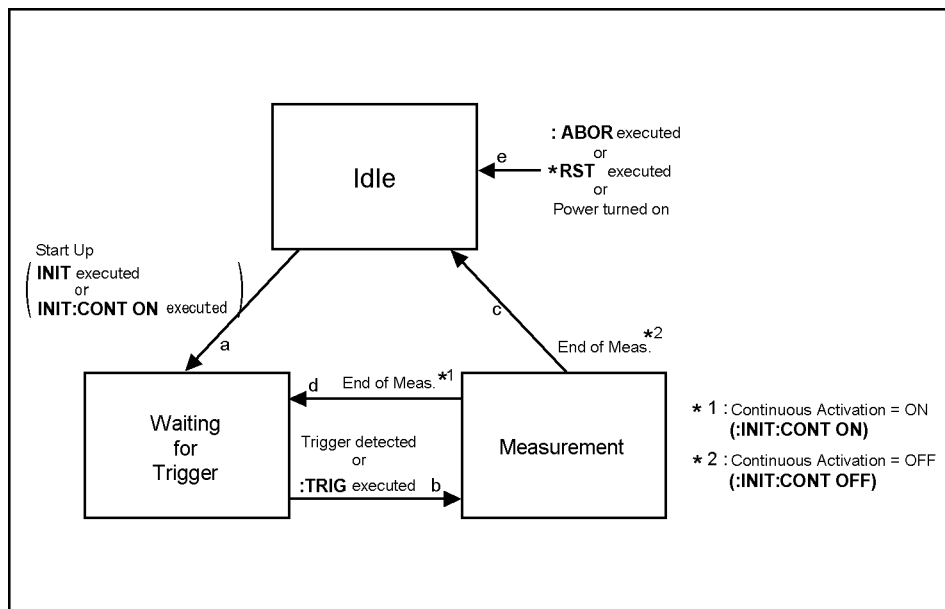

The following subsections describe each state and how the trigger system switches among the three states.

Idle state

The trigger system is put into Idle state (arrow e in Figure 5-1) when you power on the instrument or issue one of the following commands:

- *RST on page 200
- :ABOR on page 203

The trigger system is put into Waiting for Trigger state (arrow a in Figure 5-1) when you activate it with one of the following commands:

- :INIT on page 281
- :INIT:CONT on page 281 ("ON" specified)

Waiting for Trigger state (Trigger Event Detect state)

The trigger system is put into Measurement state (arrow b in Figure 5-1) after the elapse of the trigger delay time (set with the :TRIG:DEL command on page 302) if the instrument is triggered (a trigger is detected) or the :TRIG command on page 302 is issued while the trigger system is in Waiting for Trigger state.

As shown in the table below, how the instrument is triggered differs depending on which trigger source is specified. To specify the trigger source, use the :TRIG:SOUR command on page 304.

Trigger source	How the instrument is triggered
Internal trigger	The instrument is automatically triggered within itself.
External trigger	The instrument is triggered when a trigger signal is input through the Ext TRIGGER terminal or handler interface.
GPIB/LAN trigger (Bus)	The instrument is triggered when the *TRG command on page 202 or TRIGGER command of HP BASIC is issued.
Manual trigger	The instrument is triggered when the [Trigger] key on the front panel is pressed.

Figure 5-2

Transition from Waiting for Trigger state to Measurement state

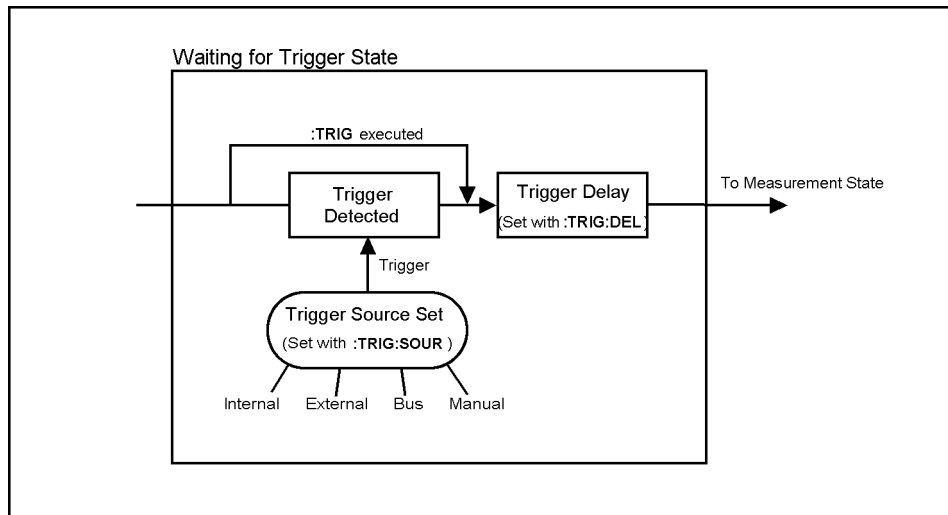

4287ape003

Starting Measurement Cycle (Triggering) and Detecting End of Measurement Starting a New Measurement Cycle (Triggering)

Measurement state (sequence operation state)

In Measurement state, the trigger system waits until the measurement point delay time (set with the `:TRIG:SEQ2:DEL` command on page 303) elapses and then starts measurement for each measurement point.

When the instrument has finished measuring the DUT at the single specified point (for single-point measurement) or at all the points defined in the active table (for list measurement), the trigger system switches to either Idle or Waiting for Trigger state depending on whether continuous activation is off or on (set with the `:INIT:CONT` command on page 281):

If continuous activation is off:

Switches to Idle state (arrow c in Figure 5-1).

If continuous activation is on:

Switches to Waiting for Trigger state (arrow d in Figure 5-1).

Starting a measurement cycle (Triggering the instrument)

Configuring the instrument to automatically perform continuous measurement (initial setting):

- Step 1.** Issue the :TRIG:SOUR command on page 304 to set the trigger source to Internal trigger.
- Step 2.** If the trigger system is in Idle state (that is, it is not currently active), issue the :INIT:CONT command on page 281 to turn on continuous activation of the trigger system.

Starting measurement on demand:

1) To trigger the instrument on demand, follow the steps below.

- Step 1.** Issue the :TRIG:SOUR command on page 304 to set the trigger source to GPIB/LAN trigger.
- Step 2.** If the trigger system is in Idle state (that is, it is not currently active), issue the :INIT:CONT command to turn on continuous activation of the trigger system.
- Step 3.** Trigger the instrument whenever you want to perform measurement. An external controller can trigger the instrument with one of the following two commands:

Command	Query response	Applicable trigger source
*TRG on page 202	Yes (returns measurement results)	GPIB/LAN trigger
:TRIG on page 302	No	All

- Step 4.** To start the next measurement cycle, repeat step 3.

2) To activate the trigger system on demand, follow the steps below.

- Step 1.** If the trigger system is active (that is, not in Idle state), issue the :ABOR command on page 203 to stop the trigger system.
- Step 2.** Issue the :TRIG:SOUR command on page 304 to set the trigger source to Internal trigger.
- Step 3.** You can activate the trigger system using the :INIT command on page 281 at any time. Consequently, the instrument will be automatically triggered by Internal trigger and perform one measurement cycle.
- Step 4.** To start the next measurement cycle, repeat step 3.

Waiting for (Detecting) End of Measurement

The status of the 4287A can be detected through the status registers. This section describes how to detect the end of measurement by using the status registers. For a complete description of the status report mechanism, including the specifications of each bit, see Appendix B, “Status Reporting System.”

End of measurement is reported by the operation status condition register. An SRQ (service request) is useful when you create a program that uses the information reported by this register to detect the end of measurement.

To detect the end of measurement via an SRQ, use one of the following commands:

- *SRE on page 201
- :STAT:OPER:ENAB on page 293
- :STAT:OPER:PTR on page 294
- :STAT:OPER:NTR on page 294

Follow these steps:

- Step 1.** Configure the 4287A to generate an SRQ when the bit 4 value of the operation status condition register is changed from 1 to 0.
- Step 2.** Trigger the instrument to start a measurement cycle.
- Step 3.** When an SRQ is generated, the program interrupts the measurement cycle.

Figure 5-3

SRQ generation sequence (at end of list measurement)

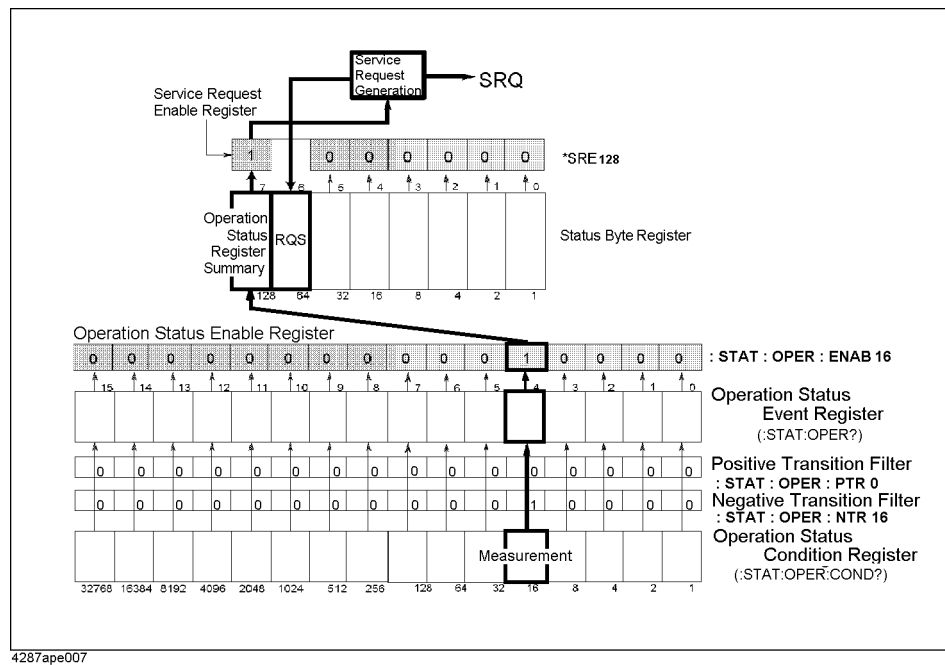

Sample program

Example 5-1 is a sample program using an SRQ to detect the end of measurement. This program is given the file name `srq_meas.bas` and stored on the sample program disk.

This program aborts the trigger system, makes the SRQ setting, and then initiates the trigger system one time. When an SRQ is generated at the end of measurement, the program displays the end message and then finishes.

Details of the program are as follows.

- Lines 30 to 40 Sets the GPIB address and the select code.
- Lines 60 to 70 Aborts the trigger system and sets the trigger source to the internal trigger.
- Lines 90 to 100 Sets the positive transition filter to 0 and the negative transition filter to 1 so that the operation status event register at bit 4 is set to 1 only when the operation status condition register at bit 4 is changed from 1 to 0.
- Lines 110 to 120 Enables bit 4 in the operation status event register and bit 8 in the status byte register.
- Lines 130 to 150 Clears the operation status event register and the status byte register.
- Lines 170 to 180 Sets the branch destination for the SRQ interrupt and enables the SRQ interrupt.
- Lines 190 to 210 Initiates the trigger system one time and then waits for the end of measurement.

Example 5-1

Detecting the end of measurement using an SRQ (`srq_meas.bas`)

```
10     DIM Buff$(9)
20     INTEGER Scode
30     ASSIGN @Agt4287a TO 717
40     Scode=7
50     !
60     OUTPUT @Agt4287a;":ABOR"
70     OUTPUT @Agt4287a;":TRIG:SOUR INT"
80     !
90     OUTPUT @Agt4287a;":STAT:OPER:PTR 0"
100    OUTPUT @Agt4287a;":STAT:OPER:NTR 16"
110    OUTPUT @Agt4287a;":STAT:OPER:ENAB 16"
120    OUTPUT @Agt4287a;":*SRE 128"
130    OUTPUT @Agt4287a;":*CLS"
140    OUTPUT @Agt4287a;":*OPC?"
150    ENTER @Agt4287a;Buff$
160    !
170    ON INTR Scode GOTO Meas_end
180    ENABLE INTR Scode;2
190    OUTPUT @Agt4287a;":INIT"
200    PRINT "Waiting..."
210 Meas_wait: GOTO Meas_wait
220 Meas_end: OFF INTR Scode
230    PRINT "Measurement Complete"
240    END
```

Starting Measurement Cycle (Triggering) and Detecting End of Measurement
Waiting for (Detecting) End of Measurement

6 Retrieving Measurement Results

This chapter explains how to retrieve the results of impedance measurement, test signal level monitoring, and R_{dc} measurement. It also describes how the Agilent 4287A internally processes the data.

Data Transfer Format

When you transfer data with the following commands, you can select either the ASCII format or binary format.

NOTE

When you transfer data with commands other than the following, you cannot select the data transfer format because it is fixed as the ASCII format.

- :FETC? on page 274
- :READ? on page 287
- *TRG on page 202
- Commands that begin with **:DATA**
 - :DATA:CAD{1-8}? on page 253
 - :DATA:CCO{1-6} on page 254
 - :DATA:CMD{1-2}? on page 255
 - :DATA:CMP{1-3} on page 256
 - :DATA:RCAD{1-3}? on page 259
 - :DATA:RCCO{1-3} on page 259
 - :DATA:RCMD{1-2}? on page 260
 - :DATA:RCMP{1-3} on page 260
 - :DATA:FDAT{1-4}? on page 257
 - :DATA:RAW? on page 258
 - :DATA:IMON? on page 257
 - :DATA:VMON? on page 261
 - :DATA:RDC? on page 261

To set the data transfer format, use the following commands:

- :FORM on page 276

NOTE

Executing the :SYST:PRES on page 300 does not affect the setting of the data transfer format.

ASCII format

When you select the ASCII format as the data transfer format, numbers are transferred as ASCII bytes, each of which corresponds to one of the formats shown below. Note that numbers are separated by a comma (,) in accordance with the IEEE 488.2 specification.

NOTE Since numeric data strings vary in length, commas appear at varying points in the data. Keep this in mind as you extract data from retrieved numeric data strings in your program.

- Integer format
Numbers are expressed as integers in this format (Figure 6-1). For example, 201 is expressed as “+201” or “201.”

Figure 6-1 Integer format

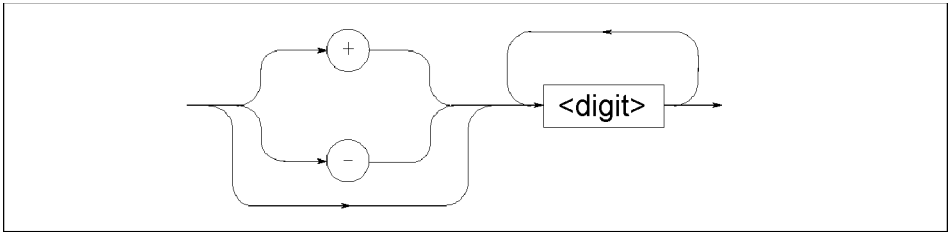

- Floating-point number format
Numbers are expressed with floating points in this format (Figure 6-2). For example, 1000 is expressed as “1.0E+3” or “+1.0E+3.”

Figure 6-2 Floating-point number format

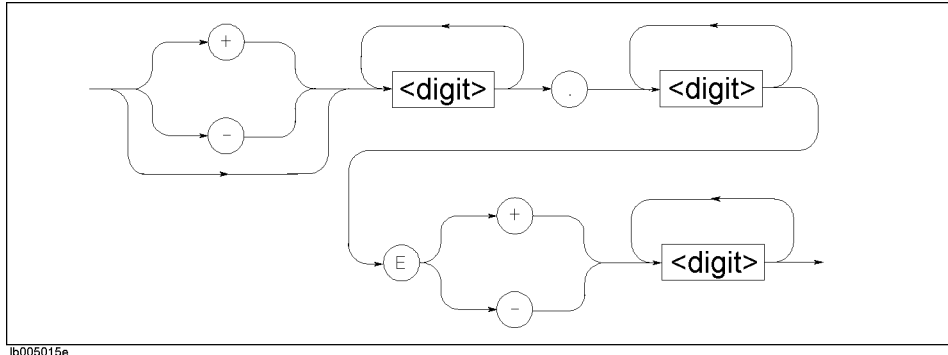

Binary format

When you select the binary format as the data transfer format, numerical data (binary data) are transferred in the format shown in Figure 6-3.

Figure 6-3

Binary Format

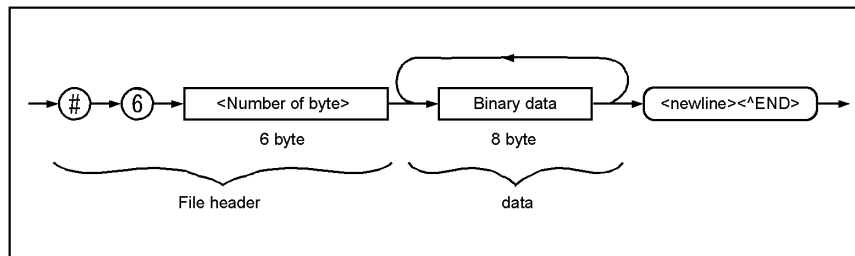

4287ape024

In this format, the data is represented with a hash (#) mark, the number 6 (indicating that <Number of bytes> is 6 bytes), the number of the binary data to be transferred (<Number of bytes>), the binary data itself, and finally the message terminator <new line>^END.

Binary data is in IEEE 754 floating point format of 64-bit configuration as shown in Figure 6-4.

Figure 6-4

64-bit Floating Point Data

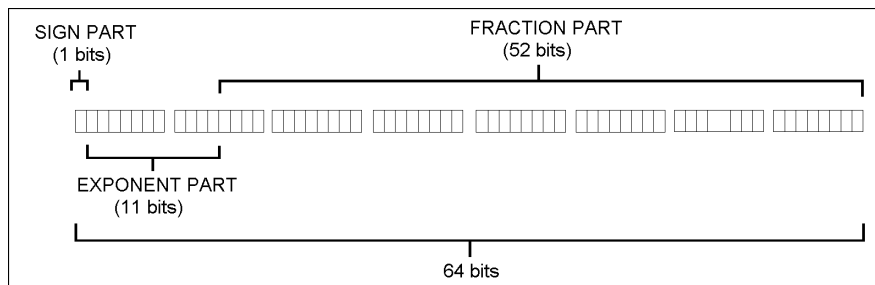

4287ape025

Byte Order

In the binary format, you can select either of the following transfer orders for each byte comprising an 8-byte data string:

- NORMAL** Data transfer begins from the byte containing MSB (Most Significant Bit, the leftmost byte shown in Figure 6-4).
- SWAPped** Data transfer begins from the byte containing LSB (Least Significant Bit, the rightmost byte shown in Figure 6-4).

To set the byte order, use the following command:

- :FORM:BORD on page 277

Internal Data Processing

Data flow

Figure 6-5 gives an overview of the 4287A's internal data processing flow.

Figure 6-5 4287A's data processing flow

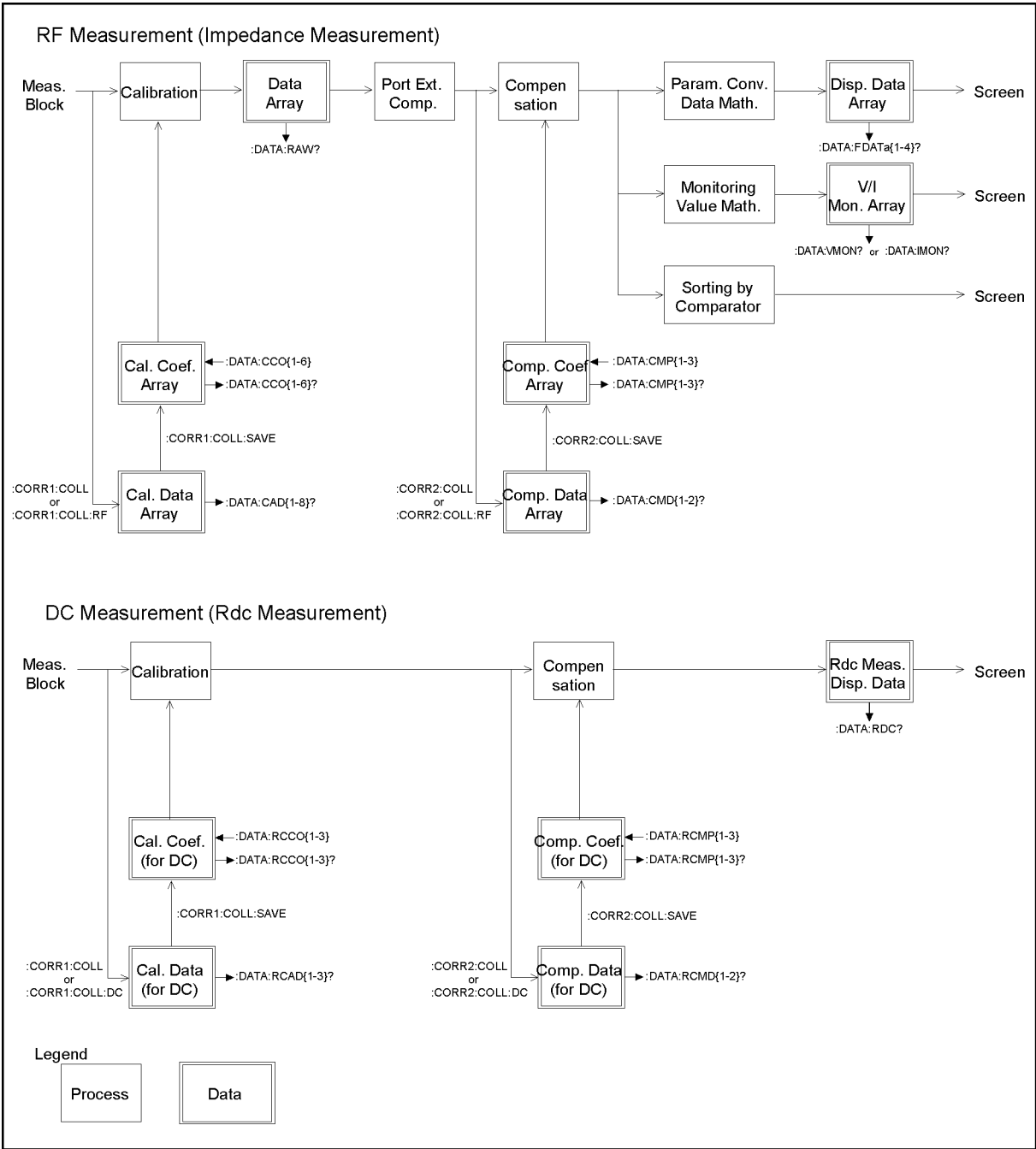

4287ape014

Internal data arrays

The instrument has a number of internal data arrays/sets that can be read and/or written and contain either real or complex numbers (Table 6-1).

Table 6-1

Internal data arrays/sets

Name of data array/set	Read	Write	Data format
Data array	Allowed	Not allowed	Complex number
Display data arrays	Allowed	Not allowed	Real number
Calibration Data Arrays	Allowed	Not allowed	Complex number
Calibration Coefficient Arrays	Allowed	Allowed	Complex number
Compensation Data Arrays	Allowed	Not allowed	Complex number
Compensation Coefficient Arrays	Allowed	Allowed	Complex number
Current/Voltage Monitor Array	Allowed	Not allowed	Real number
R _{dc} Display Data	Allowed	Not allowed	Real number
R _{dc} Calibration Data	Allowed	Not allowed	Real number
R _{dc} Calibration Coefficients	Allowed	Allowed	Real number
R _{dc} Compensation Data	Allowed	Not allowed	Real number
R _{dc} Compensation Coefficients	Allowed	Allowed	Real number

NOTE

Each table has its own calibration/compensation-related internal data arrays and data sets (including Calibration/Compensation Coefficient Arrays, Calibration/Compensation Data Arrays, R_{dc}Calibration/Compensation Coefficients, and R_{dc}Calibration/Compensation Data). When you perform command-based read/write operations on these data arrays and sets, the instrument assumes that the active table is the target.

NOTE

A complex-number array has two values (real and imaginary parts) for each measurement point, thus containing Nop×2 elements in all, where Nop represents the number of measurement points.

Data Array

The Data Array contains complex numbers (R-X) that indicate the results of calibrating raw measurement data. To retrieve the Data Array, use the following command:

- :DATA:RAW? on page 258

Display Data Arrays

As shown in the table below, the instrument has four Display Data Arrays corresponding to parameters 1 through 4. Each Display Data Array contains real numbers that indicate the results of performing port extension, compensation, measurement parameter conversion, and data math operations on the Data Array (on-screen values).

Array number ^{*1}	Indicated data
1	Data to be displayed as the measurement results for measurement parameter 1
2	Data to be displayed as the measurement results for measurement parameter 2
3	Data to be displayed as the measurement results for measurement parameter 3
4	Data to be displayed as the measurement results for measurement parameter 4

*1. Use this number as the suffix to the command.

To retrieve one of the Display Data Arrays, use the following command:

- :DATA:FDAT{1-4}? on page 257

Retrieving Measurement Results

Internal Data Processing

Calibration Data Arrays

As shown in the table below, the instrument has eight Calibration Data Arrays corresponding to two measurement passes for each of the OPEN, SHORT, LOAD, and LOW LOSS CAPACITOR standards. Each Calibration Data Array contains the standard measurement data (complex numbers) necessary for calculating the calibration coefficients.

Array number ^{*1}	Indicated data
1	First OPEN measurement data for calculating the calibration coefficients
2	First SHORT measurement data for calculating the calibration coefficients
3	First LOAD measurement data for calculating the calibration coefficients
4	First LOW LOSS CAPACITOR measurement data for calculating the calibration coefficients
5	Second OPEN measurement data for calculating the calibration coefficients
6	Second SHORT measurement data for calculating the calibration coefficients
7	Second LOAD measurement data for calculating the calibration coefficients
8	Second LOW LOSS CAPACITOR measurement data for calculating the calibration coefficients

*1. Use this number as the suffix to the command.

To retrieve one of the Calibration Data Arrays, use the following command:

- :DATA:CAD{1-8}? on page 253

Calibration Coefficient Arrays

As shown in the table below, the instrument has six Calibration Coefficient Arrays corresponding to calibration coefficients A1, B1, C1, A2, B2, and C2. Each Calibration Coefficient Array contains the calibration coefficients (complex numbers) calculated based on the Calibration Data Array.

Array number ^{*1}	Indicated data
1	Calibration coefficient A1
2	Calibration coefficient B1
3	Calibration coefficient C1
4	Calibration coefficient A2
5	Calibration coefficient B2
6	Calibration coefficient C2

*1. Use this number as the suffix to the command.

To retrieve one of the Calibration Coefficient Arrays, use the following command:

- :DATA:CCO{1-6} on page 254

NOTE

When setting calibration coefficients, note the following:

- To ensure that the instrument will provide correct measurement results, you must first configure the instrument to use the same measurement points (point setup table settings) as when you obtained measurement data for calibration and then set all the coefficients.
- You must turn on the calibration functions before setting the calibration coefficients.

Compensation Data Arrays

As shown in the table below, the instrument has two Compensation Data Arrays corresponding to the OPEN and SHORT standards. Each Compensation Data Array contains the standard measurement data (complex numbers) necessary for calculating the compensation coefficients.

Array number ^{*1}	Indicated data
1	OPEN measurement data for calculating the compensation coefficients
2	SHORT measurement data for calculating the compensation coefficients

*1. Use this number as the suffix to the command.

To retrieve one of the Compensation Data Arrays, use the following command:

- :DATA:CMD{1-2}? on page 255

Compensation Coefficient Arrays

As shown in the table below, the instrument has three Compensation Coefficient Arrays corresponding to compensation coefficients A, B, and C. Each Compensation Coefficient Array contains the compensation coefficients (complex numbers) calculated based on the Compensation Data Array.

Array number ^{*1}	Indicated data
1	Compensation coefficient A
2	Compensation coefficient B
3	Compensation coefficient C

*1. Use this number as the suffix to the command.

To retrieve one of the Compensation Coefficient Arrays, use the following command:

- :DATA:CMP{1-3} on page 256

NOTE

When setting compensation coefficients, note the following:

- To ensure that the instrument will provide correct measurement results, you must first configure the instrument to use the same measurement points (point setup table settings) as when you obtained measurement data for compensation and then turn on the calibration functions before setting the coefficients.
- You must turn on the compensation functions before setting the compensation coefficients.

Retrieving Measurement Results

Internal Data Processing

Current/Voltage Monitor Arrays

The Current/Voltage Monitor Arrays contain the real numbers to be displayed as the monitored values of the test signal voltage and current levels. Each value contained in these arrays is calculated based on the test signal level setting and the impedance value determined by performing port extension and compensation on the Data Array.

To retrieve the Voltage or Current Monitor Array, use one of the following commands:

Command	Description
:DATA:VMON? on page 261	Retrieves the Voltage Monitor Array.
:DATA:IMON? on page 257	Retrieves the Current Monitor Array.

R_{dc} Display Data

The R_{dc} Display Data is the data obtained by performing R_{dc}-specific calibration and compensation on the results of R_{dc} measurement. To retrieve this data, use the following command:

- :DATA:RDC? on page 261

Calibration coefficients and calibration data for R_{dc} measurement

When the instrument performs R_{dc} measurement (DC measurement), it uses a specific set of calibration coefficients (real numbers) that are different from those used for impedance measurement. This means that the standard measurement data (real numbers) necessary for calculating the calibration coefficients are measured and retained separately from those for impedance measurement.

The instrument has three calibration coefficients, A, B, and C, for R_{dc} measurement. To set or retrieve one of these coefficients, use one of the following commands:

- :DATA:RCCO{1-3} on page 259

Data number ^{*1}	Data to retrieve
1	R _{dc} Calibration Coefficients
2	R _{dc} Calibration Coefficients
3	R _{dc} Calibration Coefficients

*1. Use this number as the suffix to the command.

To obtain the OPEN, SHORT, or LOAD measurement data for calculating the calibration coefficients for R_{dc} measurement, use one of the following commands:

- :DATA:RCAD{1-3}? on page 259

Data number ^{*1}	Data to retrieve
1	OPEN measurement data for calculating the calibration coefficients for R _{dc} measurement
2	SHORT measurement data for calculating the calibration coefficients for R _{dc} measurement
3	LOAD measurement data for calculating the calibration coefficients for R _{dc} measurement

*1. Use this number as the suffix to the command.

R_{dc} compensation coefficients and compensation data

When the instrument performs R_{dc} measurement (DC measurement), it uses a specific set of compensation coefficients (real numbers) that are different from those used for impedance measurement. This means that the standard measurement data (real numbers) necessary for calculating the compensation coefficients is measured and retained separately from those for impedance measurement.

The instrument has three compensation coefficients, A, B, and C, for R_{dc} measurement. To set or retrieve one of these coefficients, use one of the following commands:

- :DATA:RCMP{1-3} on page 260

Data number ^{*1}	Data to retrieve
1	R _{dc} Calibration Coefficient A
2	R _{dc} Calibration Coefficient B
3	R _{dc} Calibration Coefficient C

*1. Use this number as the suffix to the command.

To obtain the OPEN or SHORT measurement data for calculating the compensation coefficients for R_{dc} measurement, use one of the following commands:

- :DATA:RCMD{1-2}? on page 260

Data number ^{*1}	Data to retrieve
1	OPEN measurement data for calculating the compensation coefficients for R _{dc} measurement
2	SHORT measurement data for calculating the compensation coefficients for R _{dc} measurement

*1. Use this number as the suffix to the command.

Retrieving the Measurement Results for Measurement Parameters 1 through 4

This section describes how to retrieve the measurement results for each of the measurement parameters 1 through 4.

In addition to the `:DATA:FDAT{1-4}?` command on page 257 that retrieves the measurement results for the four measurement parameters directly from the internal Data Array, you can use the following three commands to retrieve these measurement results as well as the measurement status, the results of test signal monitoring, R_{dc} measurement, and bin sorting.

- `*TRG` on page 202
- `:FETC?` on page 274
- `:READ?` on page 287

The following table summarizes how to retrieve the measurement results for measurement parameters 1 through 4:

	Applicable trigger source	Retrieval steps
*TRG command	GPIB/LAN trigger (bus)	Issue the *TRG command. ↓ The command returns the data.
:FETC? command or :DATA:FDAT{1-4}? command	All	Trigger the instrument. ↓ :FETC? or :DATA:FDAT{1-4}? command.*1 ↓ The command returns the data.
:READ? command	External trigger Manual trigger Internal trigger	Issue the :READ? command. ↓ Trigger the instrument. ↓ The command returns the data.

*1. The end-of-measurement signal must be detected before the `:FETC?` or `:DATA:FDAT{1-4}?` command is issued.

NOTE

The TRIGGER command of HP BASIC has the same function as the ***TRG** command.

Retrieving Measurement Results

Retrieving the Measurement Results for Measurement Parameters 1 through 4

Using the *TRG command to retrieve measurement results

This command actually performs two tasks: it triggers the instrument and returns the results. It is useful, for example, when you want to retrieve measurement results immediately after triggering the instrument from an external controller.

To retrieve measurement results using the *TRG command, follow these steps:

- Step 1.** Issue the :TRIG:SOUR command on page 304 to set the trigger source to “Bus.”
- Step 2.** Issue the *TRG command (or the TRIGGER command of HP BASIC).
- Step 3.** Retrieve the measurement results. You can repeat steps 2 and 3 as needed.

Example 6-1 and Example 6-2 are sample programs that demonstrates the use of the *TRG command. Example 6-1 uses the ASCII format, and Example 6-2 uses the binary format. These programs are given the file names trg.bas and trg_real.bas and are stored on the sample program disk.

These sample programs retrieve and display the measurement status as well as the measurement results for parameters 1 and 2 and the result of test signal current level monitoring.

Example 6-1 is described in detail below:

Line 40	Sets the GPIB address.
Line 50	Sets the Point variable to the number of measurement points for single-point measurement.
Line 60	Sets the data transfer format to ASCII.
Lines 80 to 130	Instructs the instrument to show the results for measurement parameters 1 and 2 as well as the result of test signal current level monitoring while hiding the measurement results of measurement parameters 3 and 4 as well as the result of test signal voltage level monitoring.
Lines 150 to 180	Retrieves the parameter names of measurement parameters 1 and 2 and stores the names into the Para1\$ and Para2\$ variables, respectively.
Lines 200 to 210	Instructs the instrument to perform single-point measurement at the point identified by the Point variable.
Lines 220 to 230	Turns off the bin sorting and Rdc measurement functions.
Lines 270 to 280	Sets the trigger source to GPIB/LAN trigger and turns on the continuous activation of the trigger system.
Lines 320 to 360	Triggers the instrument after the trigger system is put into trigger wait state.
Line 370	Retrieves the measurement status, the measurement results for parameters 1 and 2, and the result of test signal current level monitoring and then stores the data into the Stat, Res1, Res2, and Imon variables.
Lines 410 to 420	Displays the measurement results.

Retrieving Measurement Results Retrieving the Measurement Results for Measurement Parameters 1 through 4

Example 6-1

Using the *TRG Command to Retrieve Measurement Results in the ASCII Format (trg.bas)

```

10 DIM Para1$(9),Para2$(9)
20 REAL Res1,Res2,Imon
30 INTEGER Point,Stat,Cond_reg
40 ASSIGN @Agt4287a TO 717
50 Point=1
60 OUTPUT @Agt4287a;" :FORM ASC"
70 !
80 OUTPUT @Agt4287a;" :DISP:TEXT1:CALC1 ON"
90 OUTPUT @Agt4287a;" :DISP:TEXT1:CALC2 ON"
100 OUTPUT @Agt4287a;" :DISP:TEXT1:CALC3 OFF"
110 OUTPUT @Agt4287a;" :DISP:TEXT1:CALC4 OFF"
120 OUTPUT @Agt4287a;" :DISP:TEXT1:CALC11 ON"
130 OUTPUT @Agt4287a;" :DISP:TEXT1:CALC12 OFF"
140 !
150 OUTPUT @Agt4287a;" :CALC:PAR1:FORM?"
160 ENTER @Agt4287a;Para1$
170 OUTPUT @Agt4287a;" :CALC:PAR2:FORM?"
180 ENTER @Agt4287a;Para2$
190 !
200 OUTPUT @Agt4287a;" :SOUR:LIST:STAT OFF"
210 OUTPUT @Agt4287a;" :SOUR:LIST:POIN ";Point
220 OUTPUT @Agt4287a;" :CALC:COMP OFF"
230 OUTPUT @Agt4287a;" :SOUR:LIST:RDC OFF"
240 !
250 ! Trigger source setting
260 !
270 OUTPUT @Agt4287a;" :TRIG:SOUR BUS"
280 OUTPUT @Agt4287a;" :INIT:CONT ON"
290 !
300 ! Triggering and data read
310 !
320 REPEAT
330 OUTPUT @Agt4287a;" :STAT:OPER:COND?"
340 ENTER @Agt4287a;Cond_reg
350 UNTIL BIT(Cond_reg,5)
360 OUTPUT @Agt4287a;" *TRG"
370 ENTER @Agt4287a;Stat,Res1,Res2,Imon
380 !
390 ! Display results
400 !
410 PRINT "### Result ###"
420 PRINT "Meas. Status:";Stat,Para1$&" ";Res1,Para2$&" ";Res2,"Imon
";Imon
430 !
440 END

```

Retrieving Measurement Results

Retrieving the Measurement Results for Measurement Parameters 1 through 4

Example 6-2 is described in detail below:

Lines 40 to 50	Sets the GPIB address.
Line 60	Sets the Point variable to the number of measurement points for single-point measurement.
Lines 70 to 80	Sets the data transfer format to binary and sets the byte order to normal.
Lines 100 to 150	Instructs the instrument to show the results for measurement parameters 1 and 2 as well as the result of test signal current level monitoring while hiding the measurement results of measurement parameters 3 and 4 as well as the result of test signal voltage level monitoring.
Lines 170 to 200	Retrieves the parameter names of measurement parameters 1 and 2 and stores the names into the Para1\$ and Para2\$ variables, respectively.
Lines 220 to 230	Instructs the instrument to perform single-point measurement at the point identified by the Point variable.
Lines 240 to 250	Turns off the bin sorting and Rdc measurement functions.
Lines 290 to 300	Sets the trigger source to GPIB/LAN trigger and turns on the continuous activation of the trigger system.
Lines 340 to 380	Triggers the instrument after the trigger system is put into trigger wait state.
Line 390	Retrieves the header.
Line 400	Retrieves the measurement status, the measurement results for parameters 1 and 2, and the result of test signal current level monitoring and then stores the data into the Stat, Res1, Res2, and Imon variables, respectively. Binary data must be read without being formatted; therefore, the I/O path (@Binary) is set to retrieve data without formatting them.
Line 410	Retrieves the message terminator provided at the end of the data.
Lines 450 to 460	Displays the measurement results.

Example 6-2

Using the *TRG Command to Retrieve Measurement Results in a Binary Format (trg_real.bas)

```

10   DIM Para1$[9],Para2$[9],Buff$[9]
20   REAL Stat,Res1,Res2,Imon
30   INTEGER Point,Cond_reg
40   ASSIGN @Agt4287a TO 717
50   ASSIGN @Binary TO 717;FORMAT OFF
60   Point=1
70   OUTPUT @Agt4287a;":FORM REAL"
80   OUTPUT @Agt4287a;":FORM:BORD NORM"
90   !
100  OUTPUT @Agt4287a;":DISP:TEXT1:CALC1 ON"
110  OUTPUT @Agt4287a;":DISP:TEXT1:CALC2 ON"
120  OUTPUT @Agt4287a;":DISP:TEXT1:CALC3 OFF"
130  OUTPUT @Agt4287a;":DISP:TEXT1:CALC4 OFF"
140  OUTPUT @Agt4287a;":DISP:TEXT1:CALC11 ON"
150  OUTPUT @Agt4287a;":DISP:TEXT1:CALC12 OFF"
160  !
170  OUTPUT @Agt4287a;":CALC:PAR1:FORM?"
180  ENTER @Agt4287a;Para1$
190  OUTPUT @Agt4287a;":CALC:PAR2:FORM?"
200  ENTER @Agt4287a;Para2$
210  !
220  OUTPUT @Agt4287a;":SOUR:LIST:STAT OFF"
230  OUTPUT @Agt4287a;":SOUR:LIST:POIN ";Point
240  OUTPUT @Agt4287a;":CALC:COMP OFF"
250  OUTPUT @Agt4287a;":SOUR:LIST:RDC OFF"
260  !
270  ! Trigger source setting
280  !
290  OUTPUT @Agt4287a;":TRIG:SOUR BUS"
300  OUTPUT @Agt4287a;":INIT:CONT ON"
310  !
320  ! Triggering and data read
330  !
340  REPEAT
350    OUTPUT @Agt4287a;":STAT:OPER:COND?"
360    ENTER @Agt4287a;Cond_reg
370  UNTIL BIT(Cond_reg,5)
380  OUTPUT @Agt4287a;":*TRG"
390  ENTER @Agt4287a USING "#,8A";Buff$
400  ENTER @Binary;Stat,Res1,Res2,Imon
410  ENTER @Agt4287a USING "#,A";Buff$
420  !
430  ! Display results
440  !
450  PRINT "### Result ###"
460  PRINT "Meas. Status: ";Stat; " "&Para1$&": ";Res1; " "&Para2$&": ";
Res2; " Imon: ";Imon
470  !
480  END

```

Retrieving Measurement Results

Retrieving the Measurement Results for Measurement Parameters 1 through 4

Using the `:FETC?` or `:DATA:FDAT{1-4}?` command to retrieve measurement results

These two commands are useful when you trigger the instrument without using an external controller or when you need to perform a particular task between triggering and retrieval.

To retrieve measurement results using the `:FETC?` or `:DATA:FDAT{1-4}?` command, follow these steps:

- Step 1.** Set the trigger source as necessary.
- Step 2.** Trigger the instrument using the method specific to the trigger source.

NOTE

To trigger the instrument from an external controller, use the `:TRIG` command on page 302 instead.

- Step 3.** Issue the `:FETC?` or `:DATA:FDAT{1-4}?` command upon completion of measurement.
- Step 4.** Retrieve the measurement results. You can repeat steps 2 through 4 as needed.

Example 6-3 is a sample program that demonstrates the use of the `:FETC?` command. This program is given the file name `fetch.bas` and is stored on the sample program disk.

This program checks the measurement conditions at run time, counts the data items to retrieve, and then puts the instrument into trigger wait state. Finally, after the user presses the **[Trigger]** key on the front panel and the instrument completes the measurement cycle, the program retrieves and displays the measurement results.

The program is described in detail below:

Lines 50 to 60	Sets the GPIB address and select code.
Line 70	Sets the data transfer format to ASCII.
Lines 110 to 160	Retrieves the display on/off (1/0) settings and parameter names for measurement parameters 1 through 4 and stores the settings and names into the variables Stat(1) through Stat(4) and Title\$(1) through Title\$(4).
Lines 180 to 200	Retrieves the display on/off (0/1) setting for the result of test signal current level monitoring and stores the setting into the Stat(5) variable; stores the title (Imon) for current level monitoring into the Title\$(5) variable.
Lines 220 to 240	Retrieves the display on/off (0/1) setting for the result of test signal voltage level monitoring and stores the setting into the Stat(6) variable; stores the title (Vmon) for voltage level monitoring into the Title\$(6) variable.
Lines 260 to 280	Retrieves the on/off (0/1) setting for the result of R_{dc} measurement and stores the setting into the Stat(7) variable; stores the title (Rdc) for R_{dc} measurement into the Title\$(7) variable.
Lines 300 to 310	Retrieves the on/off (0/1) setting of bin sorting and stores the setting into the Bin_stat variable.
Lines 330 to 340	Retrieves the list/single-point (0/1) measurement setting and stores the setting into the List_stat variables.

Retrieving Measurement Results

Retrieving the Measurement Results for Measurement Parameters 1 through 4

Lines 360 to 370	If list measurement is specified (List_stat variable = 1), the program retrieves the number of measurement points and stores the data into the Stop_no variable while storing “1” into the Star_no variable.
Lines 360 to 370	If single-point measurement is specified (List_stat is not equal to 1), the program retrieves the identification number of the specific measurement point and stores the data into the Stop_no and Star_no variables.
Lines 450 to 460	Calculates the data size and resizes the Res array.
Lines 500 to 520	After measurement is stopped (the trigger system is stopped), the program sets the trigger source to Manual trigger and turns on the continuous activation of the trigger system.
Lines 560 to 620	Instructs the instrument to generate an SRQ upon completion of measurement and clears the status byte register and operation status event register.
Lines 660 to 670	Sets the branch target for an SRQ interrupt to enable SRQ interrupts.
Lines 680 to 690	Prompts the user to press the [Trigger] key. The program waits until the user presses the [Trigger] key and the instrument completes the measurement cycle.
Lines 710 to 720	Retrieves the measurement results and stores them into the Res array.
Lines 760 to 830	Displays the title portions of the retrieved measurement results.
Lines 860 to 960	Iterates the following steps for each of the measurement points from Star_no to Stop_No. <ol style="list-style-type: none"> 1. Lines 870 to 880: Displays the measurement status and proceeds to the next data position. 2. Lines 890 to 940: Displays the results for measurement parameters 1 through 4, test signal current/voltage level monitoring, and R_{dc} measurement if the corresponding array element, Stat(*), is 1; then proceeds to the next data position.
Lines 970 to 990	If Bin_stat is 1 and bin sorting is on, the program displays the results of bin sorting.

Retrieving Measurement Results

Retrieving the Measurement Results for Measurement Parameters 1 through 4

Example 6-3

Using the :FETC? Command to Retrieve Measurement Results (fetch.bas)

```
10 DIM Title$(1:7)[9],Buff$(9)
20 REAL Res(1:257)
30 INTEGER Stat(1:7),Bin_stat,List_stat,Star_no,Stop_no,Data_size,
Loc,I,J
40 CLEAR SCREEN
50 ASSIGN @Agt4287a TO 717
60 Scode=7
70 OUTPUT @Agt4287a;":FORM ASC"
80 !
90 ! Check Condition
100 !
110 FOR I=1 TO 4
120 OUTPUT @Agt4287a;":DISP:TEXT1:CALC"&VAL$(I)&"?"
130 ENTER @Agt4287a;Stat(I)
140 OUTPUT @Agt4287a;":CALC:PAR"&VAL$(I)&" :FORM?"
150 ENTER @Agt4287a;Title$(I)
160 NEXT I
170 !
180 OUTPUT @Agt4287a;":DISP:TEXT1:CALC11?"
190 ENTER @Agt4287a;Stat(5)
200 Title$(5)="Imon"
210 !
220 OUTPUT @Agt4287a;":DISP:TEXT1:CALC12?"
230 ENTER @Agt4287a;Stat(6)
240 Title$(6)="Vmon"
250 !
260 OUTPUT @Agt4287a;":SOUR:LIST:RDC?"
270 ENTER @Agt4287a;Stat(7)
280 Title$(7)="Rdc"
290 !
300 OUTPUT @Agt4287a;":CALC:COMP?"
310 ENTER @Agt4287a;Bin_stat
320 !
330 OUTPUT @Agt4287a;":SOUR:LIST:STAT?"
340 ENTER @Agt4287a;List_stat
350 IF List_stat=1 THEN
360 OUTPUT @Agt4287a;":SOUR:LIST:SIZE?"
370 ENTER @Agt4287a;Stop_no
380 Star_no=1
390 ELSE
400 OUTPUT @Agt4287a;":SOUR:LIST:POIN?"
410 ENTER @Agt4287a;Stop_no
420 Star_no=Stop_no
430 END IF
440 !
450 Data_size=(1+Stat(1)+Stat(2)+Stat(3)+Stat(4)+Stat(5)+Stat(6)+Stat
(7))* (Stop_no-Star_no+1)+Bin_stat
460 REDIM Res(1:Data_size)
470 !
480 ! Trigger source setting
490 !
500 OUTPUT @Agt4287a;":ABOR"
510 OUTPUT @Agt4287a;":TRIG:SOUR MAN"
520 OUTPUT @Agt4287a;":INIT:CONT ON"
530 !
540 ! Status register setting (For SRQ)
550 !
560 OUTPUT @Agt4287a;":STAT:OPER:PTR 0"
570 OUTPUT @Agt4287a;":STAT:OPER:NTR 16"
580 OUTPUT @Agt4287a;":STAT:OPER:ENAB 16"
590 OUTPUT @Agt4287a;":*SRE 128"
```

Retrieving Measurement Results Retrieving the Measurement Results for Measurement Parameters 1 through 4

```

600  OUTPUT @Agt4287a;"*CLS"
610  OUTPUT @Agt4287a;"*OPC?"
620  ENTER @Agt4287a;Buff$
630  !
640  ! Triggering and data read
650  !
660  ON INTR Scode GOTO Meas_end
670  ENABLE INTR Scode;2
680  PRINT "Push Trigger Key!"
690 Meas_wait: GOTO Meas_wait
700 Meas_end: OFF INTR Scode
710  OUTPUT @Agt4287a;":FETC?"
720  ENTER @Agt4287a;Res(*)
730  !
740  ! Display results
750  !
760  PRINT "### Result ###"
770  PRINT "No. Stat";
780  FOR J=1 TO 7
790    IF Stat(J)=1 THEN
800      PRINT USING "3X,5A,2X,#";Title$(J)
810    END IF
820  NEXT J
830  PRINT ""
840  !
850  Loc=1
860  FOR I=Star_no TO Stop_no
870    PRINT USING "2D,4X,D,#";I,Res(Loc)
880    Loc=Loc+1
890    FOR J=1 TO 7
900      IF Stat(J)=1 THEN
910        PRINT USING "X,MD.2DE,#";Res(Loc)
920        Loc=Loc+1
930      END IF
940    NEXT J
950    PRINT ""
960  NEXT I
970  IF Bin_stat=1 THEN
980    PRINT "BIN Sort: ";Res(Loc)
990  END IF
1000 !
1010 Prog_end:END

```

Retrieving Measurement Results

Retrieving the Measurement Results for Measurement Parameters 1 through 4

Example 6-4 is a sample program that demonstrates the use of the **:DATA:FDAT{1-4}?** command. This program is given the file name data.bas and is stored on the sample program disk.

The sample program retrieves and displays the measurement results for parameters 1 and 2 and the result of test signal current level monitoring when the instrument receives an external trigger and completes the measurement cycle. The program is described in detail below:

Lines 40 to 50	Sets the GPIB address and select code.
Line 60	Sets the Point variable to the number of measurement points for single-point measurement.
Line 70	Sets the data transfer format to ASCII.
Lines 90 to 120	Retrieves the parameter names of measurement parameters 1 and 2 and stores the names into the Para1\$ and Para2\$ variables, respectively.
Lines 140 to 150	Instructs the instrument to perform single-point measurement at the point identified by the Point variable.
Lines 190 to 210	After measurement is stopped (the trigger system is stopped), the program sets the trigger source to External trigger and turns on the continuous activation of the trigger system.
Lines 250 to 310	Instructs the instrument to generate an SRQ upon completion of measurement and clears the status byte register and operation status event register.
Lines 350 to 360	Sets the branch target for an SRQ interrupt to enable SRQ interrupts.
Lines 370 to 380	Prompts the user to input an external trigger. The program waits until the instrument receives an external trigger and completes the measurement cycle.
Lines 400 to 450	Retrieves the measurement results for parameters 1 and 2 and the result of test signal current level monitoring and stores the data into the Res1, Res2, and Imon variables, respectively.
Lines 490 to 500	Displays the measurement results.

Example 6-4

Using the :DATA:FDAT{1-4}? Command to Retrieve Measurement Results
(data.bas)

```

10   DIM Para1$[9],Para2$[9],Buff$[9]
20   REAL Res1,Res2,Imon
30   INTEGER Point,Scode
40   ASSIGN @Agt4287a TO 717
50   Scode=7
60   Point=1
70   OUTPUT @Agt4287a;" :FORM ASC"
80   !
90   OUTPUT @Agt4287a;" :CALC:PAR1:FORM?"
100  ENTER @Agt4287a;Para1$
110  OUTPUT @Agt4287a;" :CALC:PAR2:FORM?"
120  ENTER @Agt4287a;Para2$
130  !
140  OUTPUT @Agt4287a;" :SOUR:LIST:STAT OFF"
150  OUTPUT @Agt4287a;" :SOUR:LIST:POIN ";Point
160  !
170  ! Trigger source setting
180  !
190  OUTPUT @Agt4287a;" :ABOR"
200  OUTPUT @Agt4287a;" :TRIG:SOUR EXT"
210  OUTPUT @Agt4287a;" :INIT:CONT ON"
220  !
230  ! Status register setting (For SRQ)
240  !
250  OUTPUT @Agt4287a;" :STAT:OPER:PTR 0"
260  OUTPUT @Agt4287a;" :STAT:OPER:NTR 16"
270  OUTPUT @Agt4287a;" :STAT:OPER:ENAB 16"
280  OUTPUT @Agt4287a;" *SRE 128"
290  OUTPUT @Agt4287a;" *CLS"
300  OUTPUT @Agt4287a;" *OPC?"
310  ENTER @Agt4287a;Buff$
320  !
330  ! Triggering and data read
340  !
350  ON INTR Scode GOTO Meas_end
360  ENABLE INTR Scode;2
370  PRINT "Waiting for External Trigger!"
380 Meas_wait:  GOTO Meas_wait
390 Meas_end:   OFF INTR Scode
400  OUTPUT @Agt4287a;" :DATA:FDAT1?"
410  ENTER @Agt4287a;Res1
420  OUTPUT @Agt4287a;" :DATA:FDAT2?"
430  ENTER @Agt4287a;Res2
440  OUTPUT @Agt4287a;" :DATA:IMON?"
450  ENTER @Agt4287a;Imon
460  !
470  ! Display results
480  !
490  PRINT "### Result ###"
500  PRINT Para1$&" ";Res1,Para2$&" ";Res2," Imon:" ;Imon
510  !
520  END

```

Retrieving Measurement Results

Retrieving the Measurement Results for Measurement Parameters 1 through 4

Using the **:READ?** command to retrieve measurement results

This command retrieves the measurement results synchronously with the transition from trigger wait state to end of measurement, without detecting trigger timing in the program. It is useful, for example, when you want to trigger the instrument from an external device, such as a handler, and immediately pass the measurement results to an external controller.

To retrieve measurement results using the **:READ?** command, follow these steps:

- Step 1.** Issue the **:TRIG:SOUR** command to set the trigger source to Internal, External or Manual trigger.
- Step 2.** Issue the **:READ?** command.
- Step 3.** Trigger the instrument using the method specific to the trigger source.
- Step 4.** Retrieve the measurement results. You can repeat steps 2 through 4 as needed.

Example 6-5 shows a sample program. This program is given the file name read.bas and is stored on the sample program disk.

The sample program retrieves and displays the measurement status, the measurement results for parameters 1 and 2, and the result of test signal current level monitoring when the instrument receives an external trigger and completes the measurement cycle. The program is described in detail below:

Line 40	Sets the GPIB address.
Line 50	Sets the Point variable to the number of measurement points for single-point measurement.
Line 60	Sets the data transfer format to ASCII.
Lines 80 to 130	Instructs the instrument to show the results for measurement parameters 1 and 2 as well as the result of test signal current level monitoring while hiding the measurement results of measurement parameters 3 and 4 as well as the result of test signal voltage level monitoring.
Lines 150 to 180	Retrieves the parameter names of measurement parameters 1 and 2 and stores the names into the Para1\$ and Para2\$ variables, respectively.
Lines 200 to 210	Instructs the instrument to perform single-point measurement at the point identified by the Point variable.
Lines 220 to 230	Turns off the bin sorting and Rdc measurement functions.
Lines 270 to 280	After measurement is stopped (the trigger system is stopped), the program sets the trigger source to External trigger.
Lines 320 to 330	After issuing the :READ? command, the program prompts the user to input an external trigger. The program waits until the instrument receives an external trigger and completes the measurement cycle.
Line 340	Retrieves the measurement status, the measurement results for parameters 1 and 2, and the result of test signal current level monitoring, then stores the data into the Stat, Res1, Res2, and Imon variables, respectively.
Lines 380 to 390	Displays the measurement results.

Example 6-5

Using the :READ? Command to Retrieve Measurement Results (read.bas)

```

10 DIM Para1$[9],Para2$[9]
20 REAL Res1,Res2,Imon
30 INTEGER Point,Stat
40 ASSIGN @Agt4287a TO 717
50 Point=1
60 OUTPUT @Agt4287a;":FORM ASC"
70 !
80 OUTPUT @Agt4287a;":DISP:TEXT1:CALC1 ON"
90 OUTPUT @Agt4287a;":DISP:TEXT1:CALC2 ON"
100 OUTPUT @Agt4287a;":DISP:TEXT1:CALC3 OFF"
110 OUTPUT @Agt4287a;":DISP:TEXT1:CALC4 OFF"
120 OUTPUT @Agt4287a;":DISP:TEXT1:CALC11 ON"
130 OUTPUT @Agt4287a;":DISP:TEXT1:CALC12 OFF"
140 !
150 OUTPUT @Agt4287a;":CALC:PAR1:FORM?"
160 ENTER @Agt4287a;Para1$
170 OUTPUT @Agt4287a;":CALC:PAR2:FORM?"
180 ENTER @Agt4287a;Para2$
190 !
200 OUTPUT @Agt4287a;":SOUR:LIST:STAT OFF"
210 OUTPUT @Agt4287a;":SOUR:LIST:POIN ";Point
220 OUTPUT @Agt4287a;":CALC:COMP OFF"
230 OUTPUT @Agt4287a;":SOUR:LIST:RDC OFF"
240 !
250 ! Trigger source setting
260 !
270 OUTPUT @Agt4287a;":ABOR"
280 OUTPUT @Agt4287a;":TRIG:SOUR EXT"
290 !
300 ! Triggering and data read
310 !
320 OUTPUT @Agt4287a;":READ?"
330 PRINT "Waiting for External Trigger!"
340 ENTER @Agt4287a;Stat,Res1,Res2,Imon
350 !
360 ! Display results
370 !
380 PRINT "### Result ###"
390 PRINT "Meas. Status: ";Stat,Para1$&";";Res1,Para2$&";";Res2,"Imon
: ";Imon
400 !
410 END

```

Retrieving Measurement Results

Retrieving the Measurement Results for Measurement Parameters 1 through 4

Trigger Input Timing When Using the :READ? Command

When executing the **:READ?** command while specifying its parameter (specifying the active table), you must start measurement (provide a trigger) after changing the table to obtain a correct measurement result.

Even if you execute the **:READ?** command without specifying its parameter when the controller outputting the trigger is different from the controller executing the **:READ?** command, you must provide the trigger output controller with the information on whether the **:READ?** command has been executed in order to control the timing of the trigger output appropriately (i.e., provide a trigger after the execution of the **:READ?** command).

As shown in Figure 6-6, you can obtain this information from the `/READY_FOR_TRIG` signal of the handler interface.

Figure 6-6

Operation of the `/READY_FOR_TRIG` signal when executing the **:READ?** command

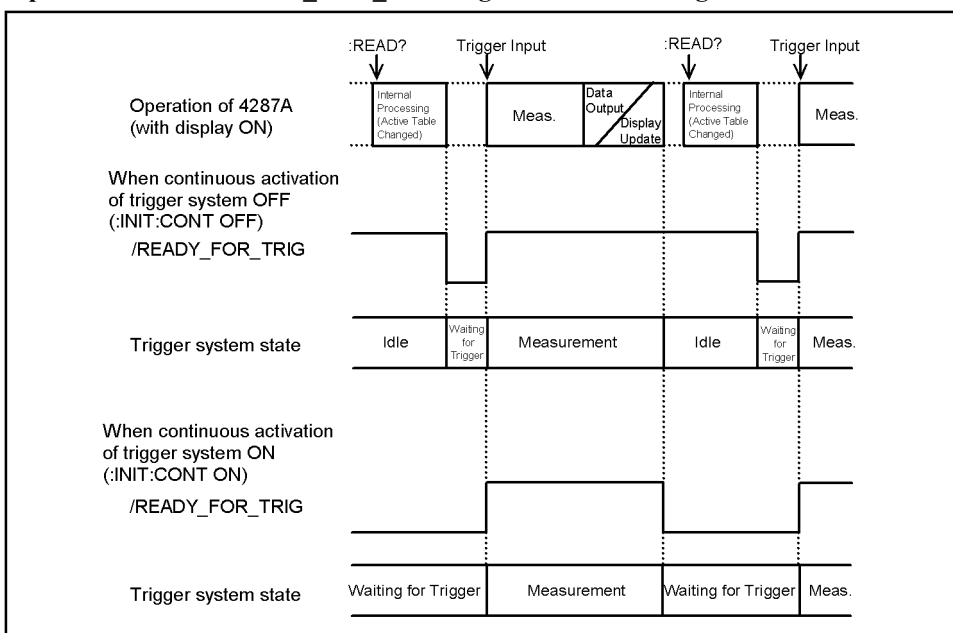

4287ape027

If you execute the **:READ?** command while the trigger system is in idle state, as shown in Figure 6-6, after the internal processing (including change processing of the active table) that follows the reception of the command is completed, the `/READY_FOR_TRIG` signal of the handler interface changes from the High level to the Low level.

However, if continuous activation of the trigger system is turned on, as shown in Figure 6-6, when display update finishes after the completion of the measurement, the `/READY_FOR_TRIG` signal changes from the High level to the Low level because the trigger system goes into Waiting for Trigger state instead of idle state. Therefore, you cannot obtain the information on whether the **:READ?** command has been executed. For this reason, you must first turn off continuous activation of the trigger system (execute `:INIT:CONT` command on page 281 specifying OFF or execute `:ABOR` command on page 203).

NOTE

In Figure 6-6, the **:READ?** command is executed after the display is updated, but it can also be executed before the update, provided that data output has finished (the query of the previous **:READ?** command has finished). Note that the internal processing still starts after the completion of the update.

Retrieving the Monitored Values of Test Signal Levels

To retrieve only the monitored values of test signal levels, use the following commands:

- `:DATA:IMON?` on page 257
- `:DATA:VMON?` on page 261

As described in “Retrieving the Measurement Results for Measurement Parameters 1 through 4” on page 85, you can also use the following three commands to retrieve the monitoring results along with other data such as the measurement results for measurement parameters 1 through 4:

- `*TRG` on page 202
- `:FETC?` on page 274
- `:READ?` on page 287

Example 6-6 is a sample program that demonstrates the use of the `:DATA:IMON?` and `:DATA:VMON?` commands. This program is given the file name `lvl_mon.bas` and is stored on the sample program disk.

The sample program retrieves and displays the test signal current and voltage levels monitored during the last measurement cycle.

The program is described in detail below:

Line 30	Sets the GPIB address.
Lines 50 to 60	Retrieves the list/single-point (0/1) measurement setting and stores the setting into the <code>List_stat</code> variables.
Lines 80 to 90	If list measurement is specified (<code>List_stat</code> variable = 1), the program retrieves the number of measurement points and stores the data into the <code>Nop</code> variable.
Line 110	If single-point measurement is specified (<code>List_stat</code> is not equal to 1), the program stores 1 into the <code>Nop</code> variable.
Line 130	Resizes the <code>I_mon</code> and <code>V_mon</code> arrays based on the value of the <code>Nop</code> variable.
Line 150	Sets the data transfer format to ASCII.
Lines 160 to 170	Reads the test signal current level and stores it into the <code>I_mon</code> array.
Lines 180 to 190	Reads the test signal voltage level and stores it into the <code>V_mon</code> array.
Lines 230 to 320	Converts the monitored current and voltage levels into the corresponding mA and mV values and displays them on screen.

Retrieving Measurement Results

Retrieving the Monitored Values of Test Signal Levels

Example 6-6

Retrieving the Monitored Values of Test Signal Levels (lvl_mon.bas)

```
10 REAL I_mon(1:32),V_mon(1:32)
20 INTEGER List_stat,Nop,I
30 ASSIGN @Agt4287a TO 717
40 !
50 OUTPUT @Agt4287a;":SOUR:LIST:STAT?"
60 ENTER @Agt4287a;List_stat
70 IF List_stat=1 THEN
80     OUTPUT @Agt4287a;":SOUR:LIST:SIZE?"
90     ENTER @Agt4287a;Nop
100 ELSE
110     Nop=1
120 END IF
130 REDIM I_mon(1:Nop),V_mon(1:Nop)
140 !
150 OUTPUT @Agt4287a;":FORM ASC"
160 OUTPUT @Agt4287a;":DATA:IMON?"
170 ENTER @Agt4287a;I_mon(*)
180 OUTPUT @Agt4287a;":DATA:VMON?"
190 ENTER @Agt4287a;V_mon(*)
200 !
210 ! Display results
220 !
230 PRINT "[Test Signal Monitor Value]"
240 IF List_stat=1 THEN
250     PRINT "No. Current[mA] Voltage[mV]"
260     FOR I=1 TO Nop
270         PRINT USING "2D,4X,2D.4D,6X,2D.4D";I,I_mon(I)*1000,V_mon(I)*10
00
280     NEXT I
290 ELSE
300     PRINT " Current[mA]:";I_mon(1)*1000
310     PRINT " Voltage[mV]:";V_mon(1)*1000
320 END IF
330 !
340 END
```

Retrieving the Results of R_{dc} Measurement

Retrieving measurement results

To retrieve only the results of R_{dc} measurement, use the following command:

- :DATA:RDC? on page 261

As described in “Retrieving the Measurement Results for Measurement Parameters 1 through 4” on page 85, you can also use the following three commands to retrieve the R_{dc} measurement results along with other data such as the measurement results for measurement parameters 1 through 4:

- *TRG on page 202
- :FETC? on page 274
- :READ? on page 287

Retrieving limit test results

To determine whether the R_{dc} measurement results fall within the limit range (defined with the :CALC:COMP:RDC:LIM command), use the following command:

- :CALC:COMP:DATA:RDC? on page 216

Also, you can use the *TRG or similar command to retrieve the measurement results as well as the measurement status and then obtain the R_{dc} measurement limit test results from that measurement status.

As shown below, the measurement status is 0 or 1 when the R_{dc} measurement results fall within the limit range and 2 or 3 when the R_{dc} measurement results do NOT fall within the limit range.

Value of Measurement Status

- 0: Normal
- 1: Measurement failure (overload)
- 2: R_{dc} measurement result did not fall within the limit range
- 3: Measurement failed and DUT did not fall within R_{dc} limit.

Sample program

Example 6-7 shows a sample program. This program is given the file name rdc.bas and is stored on the sample program disk.

The sample program sets the limit range for R_{dc} measurement, turns on the R_{dc} measurement function, and then puts the instrument into trigger wait state. Finally, when the user presses the **[Trigger]** key on the front panel and the instrument completes the measurement cycle, the program retrieves and displays the R_{dc} measurement and limit test results.

The program is described in detail below:

Lines 30 to 40	Sets the GPIB address and select code.
Lines 50 to 60	Stores the upper and lower limits for R_{dc} measurement into the L_lim and U_lim variables.
Line 70	Sets the data transfer format to ASCII.
Line 110	Sets the limit range for R_{dc} measurement values to the range between L_lim and U_lim
Lines 120 to 130	Turns on the bin sorting and R_{dc} measurement functions.
Lines 170 to 190	After measurement is stopped (the trigger system is stopped), the program sets the trigger source to External trigger and turns on the continuous activation of the trigger system.
Lines 230 to 290	Instructs the instrument to generate an SRQ upon completion of measurement and clears the status byte register and operation status event register.
Lines 330 to 340	Sets the branch target for an SRQ interrupt to enable SRQ interrupts.
Lines 350 to 360	Prompts the user to press the [Trigger] key. The program waits until the user presses the [Trigger] key and the instrument completes the measurement cycle.
Lines 380 to 390	Retrieves the R_{dc} measurement result and stores it into the Rdc variable.
Lines 400 to 410	Retrieves the R_{dc} measurement limit test result and stores it into the Rdc_test variable.
Lines 450 to 500	Displays the R_{dc} measurement value as well as the R_{dc} measurement limit test results.

Example 6-7

Retrieving the Results of R_{dc} Measurement (rdc.bas)

```
10 REAL L_lim,U_lim,Rdc
20 INTEGER Scode,Rdc_test
30 ASSIGN @Agt4287a TO 717
40 Scode=7
50 L_lim=-5
60 U_lim=5
70 OUTPUT @Agt4287a;"FORM ASC"
80 !
90 ! Rdc measurement setting
100 !
110 OUTPUT @Agt4287a;"CALC:COMP:RDC:LIM ";L_lim;" ";U_lim
120 OUTPUT @Agt4287a;"CALC:COMP ON"
130 OUTPUT @Agt4287a;"SOUR:LIST:RDC ON"
140 !
150 ! Trigger source setting
160 !
170 OUTPUT @Agt4287a;"ABOR"
180 OUTPUT @Agt4287a;"TRIG:SOUR MAN"
190 OUTPUT @Agt4287a;"INIT:CONT ON"
200 !
210 ! Status register setting (For SRQ)
220 !
230 OUTPUT @Agt4287a;"STAT:OPER:PTR 0"
240 OUTPUT @Agt4287a;"STAT:OPER:NTR 16"
250 OUTPUT @Agt4287a;"STAT:OPER:ENAB 16"
260 OUTPUT @Agt4287a;"*SRE 128"
270 OUTPUT @Agt4287a;"*CLS"
280 OUTPUT @Agt4287a;"*OPC?"
290 ENTER @Agt4287a;Buff$
300 !
310 ! Triggering and data read
320 !
330 ON INTR Scode GOTO Meas_end
340 ENABLE INTR Scode;2
350 PRINT "Push Trigger Key!"
360 Meas_wait: GOTO Meas_wait
370 Meas_end: OFF INTR Scode
380 OUTPUT @Agt4287a;"DATA:RDC?"
390 ENTER @Agt4287a;Rdc
400 OUTPUT @Agt4287a;"CALC:COMP:DATA:RDC?"
410 ENTER @Agt4287a;Rdc_test
420 !
430 ! Display results
440 !
450 PRINT "Rdc measurement value:";Rdc;
460 IF Rdc_test=1 THEN
470 PRINT " (LIMIT IN)"
480 ELSE
490 PRINT " (LIMIT OUT)"
500 END IF
510 !
520 END
```

Retrieving Measurement Results
Retrieving the Results of Rdc Measurement

7

Sorting DUTs Based on Measurement Results

This chapter explains how to use the bin sorting function to sort DUTs into a number of configured bins based on measurement results.

Setting Up the Bin Sorting Function

Turning on/off the bin sorting function (comparator)

To enable or disable the bin sorting function (comparator), use the following command:

- `:CALC:COMP` on page 205

Setting the beep condition

You can configure the instrument to beep under one of the following two conditions:

- When a DUT has failed to pass the bin sorting criteria (i.e., sorted into a bad bin or not sorted into any bin).
- When a DUT has passed the bin sorting criteria (i.e., sorted into a good bin).

To set the beep condition, use the following command:

- `:CALC:COMP:BEEP:COND` on page 205

You can also disable the beep function. To turn on or off the beep, use the following command:

- `:SYST:BEEP2:STAT` on page 297

Setting the sorting conditions for each bin

You can define up to 4 sorting conditions for each bin. When two or more conditions are specified, the instrument tests the DUT's characteristics to the AND of those conditions.

Resetting the sorting conditions

You can initialize the on/off setting, sorting conditions, and `OUT_OF_GOOD_BINS` line setting for all bins by issuing the following command:

- `:CALC:COMP:CLE` on page 208

Enabling or disabling individual bins

You can enable or disable each bin separately. When a bin is disabled, the bin's sorting conditions are ignored and no DUT is sorted into the bin. To enable or disable a single bin, use the following command:

- `:CALC:COMP:BIN{1-13}` on page 206

Setting the boundary between good and bad bins (OUT_OF_GOOD_BINS line)

You can classify bins as good or bad. When a DUT is sorted into a bad bin, the handler interface output signal /OUT_OF_GOOD_BINS becomes active (Low). A bad bin is useful, for example, when you want to eject defective DUTs into a separate location.

NOTE

Also, the /OUT_OF_GOOD_BINS signal becomes active when a DUT is not sorted into any of bins 1 through 13. For more information, refer to Table 12-2, “Mapping between Bin Sort Results and Handler Interface Output Signals,” on page 145.

You can specify the boundary between good and bad bins (the OUT_OF_GOOD_BINS line) with the number of the good bin that is to be adjacent to the boundary. All bin numbers that are equal to or smaller than the specified bin number represent good bins, while those that are larger than the specified number represent bad bins. To set the boundary, use the following command:

- :CALC:COMP:OGB on page 217

Defining individual sorting conditions

When you define a sorting condition, you must specify the limit range as well as the measurement point number and measurement parameter that correspond to the measured values to which the limit range is applied. You can define the boundary of the limit range by specifying the boundary value either as an absolute value (“absolute mode”) or as a value relative to a reference value (“tolerance mode”). Tolerance mode is further divided into two modes: “deviation tolerance mode,” where you can specify the relative boundary value as the difference from the reference value, and “percent tolerance mode,” where you can specify the boundary value as a percentage of the reference value. Use the commands listed in the table below to define sorting conditions:

Item		Command
Applies to all bins	Information needed to identify the measured value to which the limit range is applied	Point number :CALC:COMP:COND{1-4}:SNUM on page 212
		Measurement parameter :CALC:COMP:COND{1-4}:PAR on page 211
	Limit range	Mode of boundary definition (Limit mode) :CALC:COMP:COND{1-4}:MODE on page 209
Reference value*1 :CALC:COMP:COND{1-4}:NOM on page 210		
For each bin	Boundary value :CALC:COMP:BIN{1-13}:COND{1-4}:LIM on page 207	
	Mode of bin range definition (BIN range mode) :CALC:COMP:BIN{1-13}:COND{1-4}:LTYP on page 208	

*1. Available in deviation tolerance mode and percent tolerance mode.

Sorting DUTs Based on Measurement Results Setting Up the Bin Sorting Function

Figure 7-1

Commands for defining sorting conditions

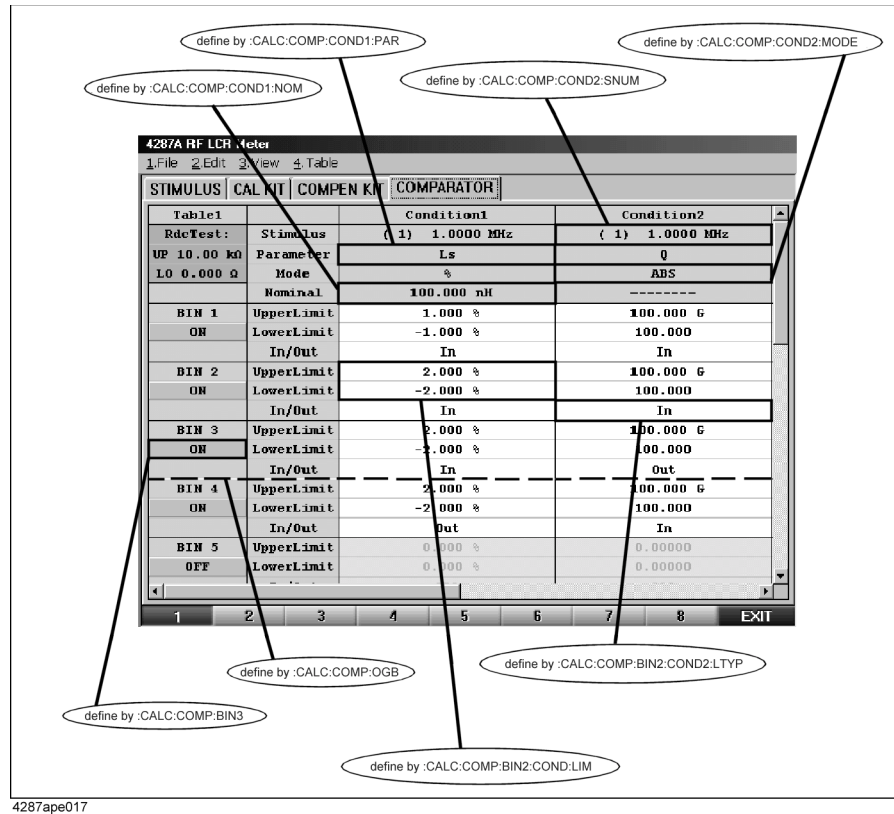

4287ape017

Table 7-1

Relationship between limit mode and measured value used for sorting

Limit mode	Absolute mode (ABS)	Deviation tolerance mode (DEV)	Percent tolerance mode (PCNT)
Measured value	<i>Meas</i>	<i>Meas - Nom</i>	$\frac{Meas - Nom}{Nom} \times 100$

where *Meas* and *Nom* mean the following:

Meas : A value obtained by converting the impedance value measured at the point specified via the **:CALC:COMP:COND{1-4}:SNUM** command into the measurement parameter value specified via the **:CALC:COMP:COND{1-4}:PAR** command.

Nom : The reference value specified via the **:CALC:COMP:COND{1-4}:NOM** command.

Table 7-2

Relationship between BIN range mode and test result (PASS/FAIL)

Range of measured value	BIN range mode		
	In	Out	All
Measured value < lower limit	FAIL	PASS	PASS
Lower limit ≤ measured value ≤ upper limit	PASS	FAIL	
Measured value > upper limit	FAIL	PASS	

Figure 7-2 Sorting flow

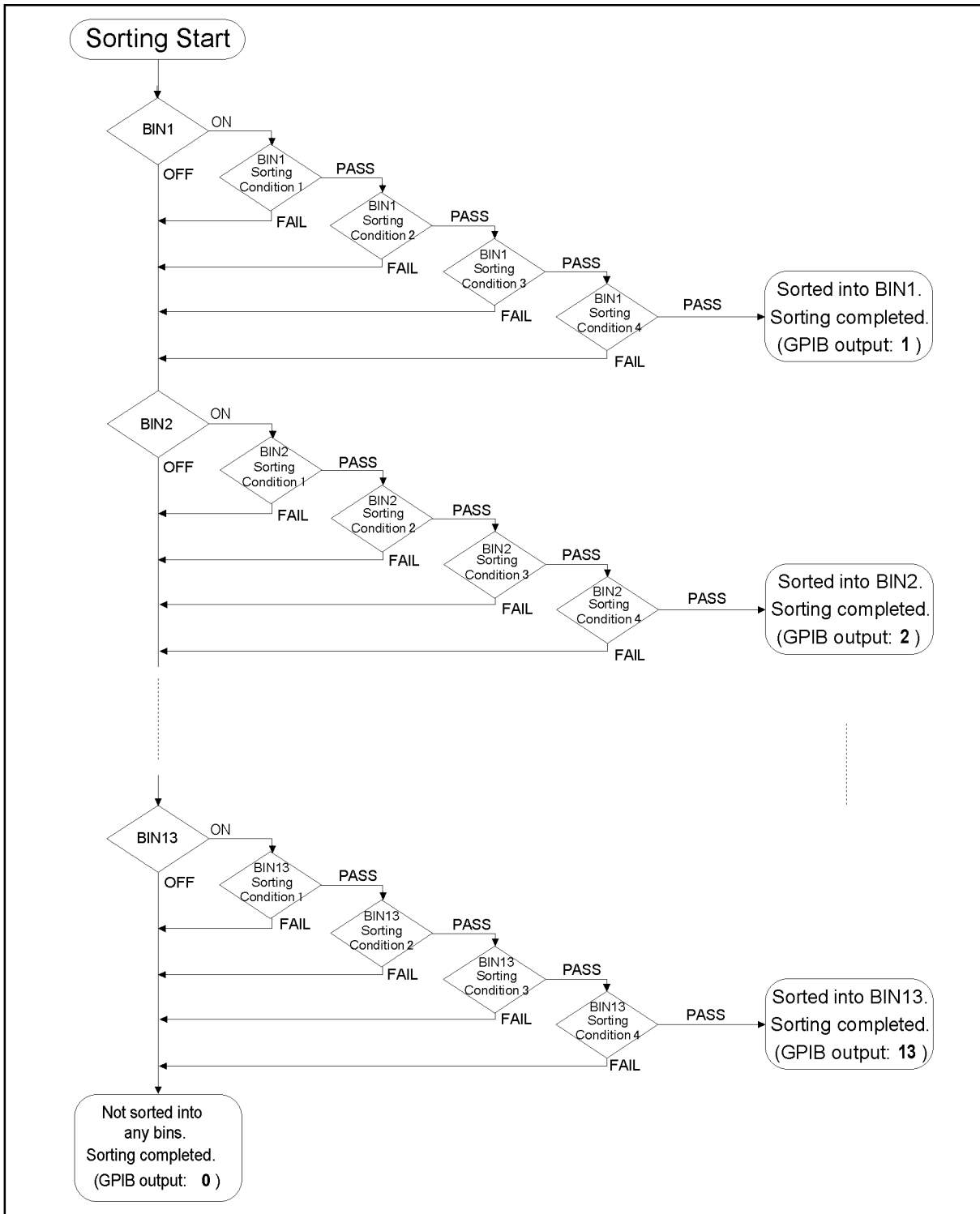

4287ape018

7. Sorting DUTs Based on Measurement Results

Retrieving the Results of Bin Sorting

To retrieve the results of bin sorting, use the following command:

- `:CALC:COMP:DATA:BIN?` on page 215

When the bin sorting function is on (that is, after you have issued the `:CALC:COMP` command on page 205 by specifying “ON”), you can use the following command to retrieve the bin sorting results as well as the measurement status and measured values.

- `*TRG` on page 202
- `:FETC?` on page 274
- `:READ?` on page 287

Whichever command you use, the result of bin sorting is represented as an integer between 0 and 14, as shown below:

- 0: Indicates a DUT not sorted into any of bins 1 through 13
- 1: Sorted into bin 1
- 2: Sorted into bin 2
- 3: Sorted into bin 3
- 4: Sorted into bin 4
- 5: Sorted into bin 5
- 6: Sorted into bin 6
- 7: Sorted into bin 7
- 8: Sorted into bin 8
- 9: Sorted into bin 9
- 10: Sorted into bin 10
- 11: Sorted into bin 11
- 12: Sorted into bin 12
- 13: Sorted into bin 13
- 14: Sort failed (due to measurement error)

NOTE

When the bin sorting function is off (that is, after you have issued the `:CALC:COMP` command by specifying “OFF”), you can use the `:CALC:COMP:DATA:BIN?` command to retrieve the result of the last bin sorting that was carried out when the bin sorting function was on. Note that this command returns 1 if no bin sorting has been performed or 0 if the instrument was reset after the last bin sorting.

Retrieving the Number of the DUTs Sorted into Each Bin (Using the Bin Count Function)

You can use the bin count function to count the number of DUTs sorted into each bin. You can count up to 2,147,483,647 ($2^{31}-1$) DUTs. If this limit is exceeded, the counter value remains at the maximum without being updated.

To turn on or off the bin count function, use the following command:

- :CALC:COMP:COUN on page 213

To retrieve the counter value, use the following command:

- :CALC:COMP:DATA:BCOU? on page 214

Also, you can clear the counter value so that you can re-count DUTs from 0 by issuing the following command:

- :CALC:COMP:COUN:CLE on page 213

Sample Program

Example 7-1 shows a sample program that demonstrates the use of the bin sorting function. You can find the source file of this program, named bin_sort.bas, on the sample program disk.

The sample program first configures the bin sorting conditions as shown in Figure 7-3 and then performs 50 measurement cycles; each time the instrument completes one measurement cycle, the program retrieves and displays the bin sorting results. Finally, after the instrument has completed the last measurement cycle, the program retrieves and displays the number of DUTs sorted into each bin.

Figure 7-3

Configuring bin sorting conditions for Example 7-1 (where frequency at point 1 is set to 10 MHz)

4287A RF LCR Meter			
1.File 2.Edit 3.View 4.Table			
STIMULUS		CAL KIT	COMPEN KIT
COMPARATOR			
Table1		Condition1	Condition2
RdcTest:	Stimulus	(1) 10.000 MHz	(1) 10.000 MHz
UP 10.00 kΩ	Parameter	Ls	Q
LO 0.000 Ω	Mode	%	ABS
	Nominal	100.000 nH	-----
BIN 1	UpperLimit	1.000 %	1.00000 G
ON	LowerLimit	-1.000 %	100.000
	In/Out	In	In
BIN 2	UpperLimit	1.000 %	1.00000 G
ON	LowerLimit	-1.000 %	100.000
	In/Out	In	Out
BIN 3	UpperLimit	1.000 %	1.00000 G
ON	LowerLimit	-1.000 %	100.000
	In/Out	Out	In
BIN 4	UpperLimit	0.000 %	0.00000
OFF	LowerLimit	0.000 %	0.00000
	In/Out	All	All
BIN 5	UpperLimit	0.000 %	0.00000
OFF	LowerLimit	0.000 %	0.00000
	In/Out	---	---

The program is described in detail below:

- Line 60 Sets the GPIB address.
- Lines 80 to 90 Stores the highest sorting condition number into the Max_cond variable and the highest bin number into the Max_bin variable.
- Line 100 Stores the highest good bin number, which serves as the boundary between the good and bad bins, into the Ogbin variable.
- Lines 120 to 210 Stores the settings for sorting conditions 1 and 2 that apply to all bins into the corresponding arrays: Point_no(*) contains the measurement points; Para\$(*) contains the selected measurement parameters; Lim_mode\$(*) contains the modes of boundary definition; Nominal(*) contains the reference values.
- Lines 220 to 300 Stores the bin 1 specific settings for sorting conditions 1 and 2 into the corresponding arrays: L_lim(1,*) contains the lower limits; U_lim(1,*) contains the upper limits; L_type\$(1,*) contains the modes

	of bin range definition.
Lines 310 to 390	Stores the bin 2 specific settings for sorting conditions 1 and 2 into the corresponding arrays: L_lim(2,*) contains the lower limits; U_lim(2,*) contains the upper limits; L_type\$(2,*) contains the modes of bin range definition.
Lines 400 to 480	Stores the bin 3 specific settings for sorting conditions 1 and 2 into the corresponding arrays: L_lim(3,*) contains the lower limits; U_lim(3,*) contains the upper limits; L_type\$(3,*) contains the modes of bin range definition.
Lines 520 to 540	Configures the instrument to perform single-point measurement at the specific measurement point (point 1) defined in active table (Table 1).
Lines 550 to 560	Configures the instrument to display Ls and Q as parameters 1 and 2, respectively.
Lines 570 to 620	Instructs the instrument to show the results for measurement parameters 1 and 2 while hiding the measurement results for measurement parameters 3 and 4 as well as the results of test signal current and voltage level monitoring.
Line 630	Turns off the R _{dc} measurement function.
Lines 670 to 680	Resets the bin sorting setup table and turns ON the bin sorting function.
Lines 690 to 830	Iterates the following steps for each of sorting conditions 1 through Meas_cond. <ol style="list-style-type: none"> 1. Lines 700 to 720: Sets the point number to Point_no(*), measurement parameter to Para(*), and limit mode to Lim_mode\$(*). 2. Lines 730 to 750: Sets the reference value to Nominal(*). Note that these statements are skipped if the boundary is defined in absolute mode. 3. Lines 720 to 820: Iterates the following steps for each bin (bin1 through Max_bin): <ol style="list-style-type: none"> a. Enables the bin and sets the BIN range mode to L_type\$(*,*). b. Sets the lower and upper limits of the bin range to L_lim(*,*) and U_lim(*,*), respectively. Note that these statements are skipped if the bin range is defined in the ALL mode.
Lines 840 to 850	Assigns all bins with their numbers greater than Ogbin as good bins and turns on the bin count function.
Line 890	Sets the data transfer format to ASCII.
Lines 900 to 920	After measurement is stopped (the trigger system is stopped), the program sets the trigger source to GPIB/LAN trigger and turns on the continuous activation of the trigger system.
Lines 930 to 950	Clears the bin counter value.
Lines 980 to 1010	Stores the result display format into the Img\$ variable and shows the title part of the result display.

Sorting DUTs Based on Measurement Results

Sample Program

Lines 1020 to 1100 Loops through the following steps 50 times:

1. Lines 1030 to 1070: Triggers the instrument after the trigger system is put into trigger wait state.
2. Lines 1080 to 1090: Retrieves the measurement results and displays them according to `Img$`.

Lines 1110 to 1200 Retrieves and displays the bin count.

Example 7-1

Using the Bin Sorting Function to Sort DUTs (`bin_sort.bas`)

```
10 DIM Para$(1:4)[9],Lim_mode$(1:4)[9],L_type$(1:13,1:4)[9],Img$[50]
20 REAL Point_no(1:4),L_lim(1:13,1:4),U_lim(1:13,1:4),Nominal(1:13)
30 REAL Stat,LS,Q,Bin_res
40 INTEGER Max_cond,Max_bin,Ogbin,Bin(1:14),I,J,Cond_reg
50 !
60 ASSIGN @Agt4287a TO 717
70 !
80 Max_cond=2
90 Max_bin=3
100 Ogbin=2
110 !
120 !====[ALL BIN]====
130 !-- Condition 1 --
140 Point_no(1)=1
150 Para$(1)="LS"
160 Lim_mode$(1)="PCNT"
170 Nominal(1)=1.0E-7
180 !-- Condition 2 --
190 Point_no(2)=1
200 Para$(2)="Q"
210 Lim_mode$(2)="ABS"
220 !====[BIN1]====
230 !-- Condition 1 --
240 L_lim(1,1)=-1.0
250 U_lim(1,1)=1.0
260 L_type$(1,1)="IN"
270 !-- Condition 2 --
280 L_lim(1,2)=100.0
290 U_lim(1,2)=1.0E+9
300 L_type$(1,2)="IN"
310 !====[BIN2]====
320 !-- Condition 1 --
330 L_lim(2,1)=-1.0
340 U_lim(2,1)=1.0
350 L_type$(2,1)="IN"
360 !-- Condition 2 --
370 L_lim(2,2)=100.0
380 U_lim(2,2)=1.0E+9
390 L_type$(2,2)="OUT"
400 !====[BIN3]====
410 !-- Condition 1 --
420 L_lim(3,1)=-1.0
430 U_lim(3,1)=1.0
440 L_type$(3,1)="OUT"
450 !-- Condition 2 --
460 L_lim(3,2)=100.0
470 U_lim(3,2)=1.0E+9
480 L_type$(3,2)="IN"
490 !
500 ! Measurement Condition Setting
510 !
```

```

520 OUTPUT @Agt4287a;" :SOUR:LIST:TABL 1"
530 OUTPUT @Agt4287a;" :SOUR:LIST:STAT OFF"
540 OUTPUT @Agt4287a;" :SOUR:LIST:POIN 1"
550 OUTPUT @Agt4287a;" :CALC:PAR1:FORM LS"
560 OUTPUT @Agt4287a;" :CALC:PAR2:FORM Q"
570 OUTPUT @Agt4287a;" :DISP:TEXT1:CALC1 ON"
580 OUTPUT @Agt4287a;" :DISP:TEXT1:CALC2 ON"
590 OUTPUT @Agt4287a;" :DISP:TEXT1:CALC3 OFF"
600 OUTPUT @Agt4287a;" :DISP:TEXT1:CALC4 OFF"
610 OUTPUT @Agt4287a;" :DISP:TEXT1:CALC11 OFF"
620 OUTPUT @Agt4287a;" :DISP:TEXT1:CALC12 OFF"
630 OUTPUT @Agt4287a;" :SOUR:LIST:RDC OFF"
640 !
650 ! Bin Sort Setup Table Setting
660 !
670 OUTPUT @Agt4287a;" :CALC:COMP:CLE"
680 OUTPUT @Agt4287a;" :CALC:COMP ON"
690 FOR I=1 TO Max_cond
700     OUTPUT @Agt4287a;" :CALC:COMP:COND"&VAL$(I)&":SNUM ";Point_no(I)
710     OUTPUT @Agt4287a;" :CALC:COMP:COND"&VAL$(I)&":PAR "&Para$(I)
720     OUTPUT @Agt4287a;" :CALC:COMP:COND"&VAL$(I)&":MODE "&Lim_mode$(
I)
730     IF Lim_mode$(I)<>"ABS" THEN
740         OUTPUT @Agt4287a;" :CALC:COMP:COND"&VAL$(I)&":NOM ";Nominal(I)
750     END IF
760     FOR J=1 TO Max_bin
770         OUTPUT @Agt4287a;" :CALC:COMP:BIN"&VAL$(J)&" ON"
780         OUTPUT @Agt4287a;" :CALC:COMP:BIN"&VAL$(J)&":COND"&VAL$(I)&":L
TYP "&L_type$(J,I)
790         IF L_type$(J,I)<>"ALL" THEN
800             OUTPUT @Agt4287a;" :CALC:COMP:BIN"&VAL$(J)&":COND"&VAL$(I)&
:LIM ";L_lim(J,I);",";U_lim(J,I)
810         END IF
820     NEXT J
830 NEXT I
840 OUTPUT @Agt4287a;" :CALC:COMP:OGB ";Ogbin
850 OUTPUT @Agt4287a;" :CALC:COMP:COUN ON"
860 !
870 ! Measurement
880 !
890 OUTPUT @Agt4287a;" :FORM ASC"
900 OUTPUT @Agt4287a;" :ABOR"
910 OUTPUT @Agt4287a;" :TRIG:SOUR BUS"
920 OUTPUT @Agt4287a;" :INIT:CONT ON"
930 OUTPUT @Agt4287a;" :CALC:COMP:COUN:CLE"
940 OUTPUT @Agt4287a;" *OPC?"
950 ENTER @Agt4287a;Buff$
960 !
970 CLEAR SCREEN
980 Img$=" 3D,3X,D,4X,MD.4DE,2X,MD.4DE,2X,2D"
990 PRINT "[MEASUREMENT and BIN SORT RESULT]"
1000 PRINT "      Status      Ls          Q          BIN"
1010 PRINT " -----"
1020 FOR I=1 TO 50
1030     REPEAT
1040         OUTPUT @Agt4287a;" :STAT:OPER:COND?"
1050         ENTER @Agt4287a;Cond_reg
1060         UNTIL BIT(Cond_reg,5)
1070         OUTPUT @Agt4287a;" *TRG"
1080         ENTER @Agt4287a;Stat,Ls,Q,Bin_res
1090         PRINT USING Img$;I,Stat,Ls,Q,Bin_res
1100     NEXT I
1110 OUTPUT @Agt4287a;" :CALC:COMP:DATA:BCOU?"
1120 ENTER @Agt4287a;Bin(*)

```

Sorting DUTs Based on Measurement Results

Sample Program

```
1130  Img$="2X,17A,5D"
1140  PRINT "[BIN COUNT RESULT]"
1150  PRINT "    BIN                Count"
1160  PRINT "  -----"
1170  FOR I=1 TO 13
1180    PRINT USING Img$;"BIN"&VAL$(I)&":",Bin(I)
1190  NEXT I
1200  PRINT USING Img$;"OUT OF GOOD BINS:",Bin(14)
1210  !
1220  END
```

8

Statistical Analysis of Measurement Results

This chapter explains how to use the statistical analysis function.

Capturing the Measurement Data for Statistical Analysis

Before performing statistical analysis, you must capture the necessary measurement data.

Setting the number of data segments to capture

To set the maximum number of the measurement data segments stored in the volatile memory, use the following command:

- `:CALC:EXAM:SIZE` on page 221

The number of data segments captured per measurement cycle is $Param \times Nop$. Accordingly, when you want to capture the measurement data for $Times$ cycles, you must set the maximum number to $Param \times Nop \times Times$. $Param$ and Nop represents the following:

Param The number of measurement items currently displayed on screen. Each measurement item can be one of measurement parameters 1 through 4, the results of test signal current/voltage level monitoring, or the result of R_{dc} measurement.

Nop The number of measurement points per measurement cycle. The number should be “1” for single-point measurement or, for list measurement, the number of points defined in the active table.

Starting data capture

You can begin capturing the measurement data for statistical analysis by issuing the command shown below. Once you have issued the command, each measured value (for measurement parameters 1 through 4, test signal current/voltage level monitoring, or R_{dc} measurement) is stored in the volatile memory (RAM) provided that the measured value is currently shown on screen.

- `:CALC:EXAM:STAR` on page 222

If previously captured data is still in the volatile memory and you issue the command, the instrument clears the existing data and then begins capturing new data.

Completion of data capture

The instrument finishes capturing the data when:

- The number of captured data segments reaches the maximum number.
- The `:CALC:EXAM:GET?` command starts another session of statistical analysis.

To check the progress of data capture, examine the number of data segments stored in the volatile memory (RAM) by issuing the following command:

- `:CALC:EXAM:POIN?` on page 220

Saving the captured data

To save the measurement data for statistical analysis from the volatile memory to a file, use the following command. See “Saving data to a file” on page 126 for more information.

- `:MMEM:STOR` on page 285

Performing Statistical Analysis

To perform statistical analysis and retrieve the results, use the following command:

- `:CALC:EXAM:GET?` on page 219

NOTE

Once you have started capturing the data for statistical analysis, changing the number of data segments to be captured per measurement cycle (for example, through switching between single-point measurement and list measurement) can generate an error. Even if no error occurs, changing the number of data segments during data capture would produce incorrect results.

Do not change the number of data segments captured per measurement cycle once you have started capturing the data for statistical analysis. If you have inadvertently changed the number of data segments, re-capture the data (by issuing the `:CALC:EXAM:STAR` command again) and then issue the command shown above.

The command shown above returns the statistics based on the measurement results at the measurement point(s) specified for each specific measurement item. The statistics include the following 10 items:

- Statistics on the measurement data set from successful measurements (i.e., measurements that were detected as neither showing an overload nor exceeding the R_{dc} limit range). These include the following:
 1. Average
 2. Standard deviation σ
 3. $3 \times \sigma / \text{average}$
 4. Minimum value
 5. Maximum value
- Count data that include the following:
 6. Number of successful measurements (number of samples used for statistical analysis)
 7. Number of measurements that were detected to exceed the R_{dc} limit range
 8. Number of measurements that were detected to show an overload
 9. Number of measurements that were detected as either exceeding the R_{dc} limit range or showing an overload or both.
 10. Total number of measurements

You can perform statistical analysis only on those measurement items that are currently displayed on screen with their underlying measurement data stored in memory. These items can include the following:

- Measurement parameter 1
- Measurement parameter 2
- Measurement parameter 3
- Measurement parameter 4
- Monitored value of the test signal current level
- Monitored value of the test signal voltage level
- Result of R_{dc} measurement

Sample Program

Example 8-1 shows a sample program that demonstrates how to perform statistical analysis. You can find the source file of this program, named `stat.bas`, on the sample program disk.

The sample program performs statistical analysis on the specified measurement items and then retrieves and displays the results of the analysis.

The program is described in detail below:

- | | |
|------------------|---|
| Line 60 | Sets the GPIB address. |
| Lines 80 to 130 | Checks the number of measurement data segments for statistical analysis stored in the volatile memory. If no such data exists, the program displays a message and terminates. |
| Lines 150 to 470 | Checks whether each measurement item is currently shown or hidden and stores the names of the currently shown items into the <code>Title(*)</code> array and the number of the shown items into the <code>Number</code> variable. The measurement items include measurement parameters 1 through 4, the monitored values of the test signal current and voltage levels, and the result of R_{dc} measurement. |
| Lines 490 to 520 | If <code>Number</code> is 0, the program displays a message and terminates. |
| Line 540 | Allows the user to return to the entry start line and re-enter the data if an error (such as an invalid entry) occurs while selecting the numbers identifying the measurement items on which to perform statistical analysis. |
| Lines 560 to 630 | Displays the list of items that can be statistically analyzed and prompts the user to choose one of the items by typing in the appropriate number. |
| Line 640 | Converts the entered value into an integer and stores it into the <code>Item</code> variable. |
| Line 650 | If the <code>Item</code> is not an integer between 1 and <code>Number</code> , returns to the entry start line. |
| Lines 690 to 700 | Displays the names of the measurement items selected for statistical analysis and then passes control to a subprogram named <code>Stat_ana</code> to perform statistical analysis and display the results. |

The `Stat_ana` subprogram in lines 760 to 1260, which performs statistical analysis, is described below.

- | | |
|------------------|---|
| Lines 810 to 820 | Retrieves the list (1)/single-point (0) measurement setting and stores the setting into the <code>List_stat</code> variables. |
| Lines 840 to 850 | If list measurement is specified (<code>List_stat</code> variable = 1), the program retrieves the number of measurement points and stores the data into the <code>Nop</code> variable. |
| Line 870 | If single-point measurement is specified (<code>List_stat</code> 1 variable not equal to 1), the program stores 1 into the <code>Nop</code> variable. |
| Lines 900 to 930 | Performs the measurement items identified by the <code>Item</code> variable and |

then retrieves the results and stores them into the Res(*) array. The subprogram repeats these steps for all of the measurement points.

Lines 950 to 1260 Displays the results of the statistical analysis.

Statistical Analysis of Measurement Results Sample Program

Example 8-1

Statistical analysis (stat.bas)

```
10 DIM Title$(1:7)[20],Para${9}
20 REAL Point
30 INTEGER Number,Disp_status,Item,I
40 CLEAR SCREEN
50 !
60 ASSIGN @Agt4287a TO 717
70 !
80 OUTPUT @Agt4287a;":CALC:EXAM:POIN?"
90 ENTER @Agt4287a;Point
100 IF Point<1 THEN
110 PRINT "NO DATA!!"
120 GOTO Prog_end
130 END IF
140 !
150 Number=1
160 FOR I=1 TO 4
170 OUTPUT @Agt4287a;":DISP:TEXT1:CALC"&VAL$(I)&"?"
180 ENTER @Agt4287a;Disp_status
190 IF Disp_status=1 THEN
200 OUTPUT @Agt4287a;":CALC:PAR"&VAL$(I)&":FORM?"
210 ENTER @Agt4287a;Para$
220 Title$(Number)="Parameter "&VAL$(I)&" ("&Para$&")"
230 Number=Number+1
240 END IF
250 NEXT I
260 !
270 OUTPUT @Agt4287a;":DISP:TEXT1:CALC11?"
280 ENTER @Agt4287a;Disp_status
290 IF Disp_status=1 THEN
300 Title$(Number)="I Level Monitor"
310 Number=Number+1
320 END IF
330 !
340 OUTPUT @Agt4287a;":DISP:TEXT1:CALC12?"
350 ENTER @Agt4287a;Disp_status
360 IF Disp_status=1 THEN
370 Title$(Number)="V Level Monitor"
380 Number=Number+1
390 END IF
400 !
410 OUTPUT @Agt4287a;":SOUR:LIST:RDC?"
420 ENTER @Agt4287a;Disp_status
430 IF Disp_status=1 THEN
440 Title$(Number)="Rdc Measurement"
450 Number=Number+1
460 END IF
470 Number=Number-1
480 !
490 IF Number=0 THEN
500 PRINT "NO ANALYSIS ITEM!!"
510 GOTO Prog_end
520 END IF
530 !
540 ON ERROR GOTO Item_select
550 Item_select:~
560 PRINT "[Statistical Analysis]"
570 PRINT " Select Analysis Item!"
580 FOR I=1 TO Number
590 PRINT " "&VAL$(I)&": "&Title$(I)
600 NEXT I
610 PRINT ""
```

```

620 PRINT "Input 1 to "&VAL$(Number)
630 INPUT "Number? ",Inp_char$
640 Item=IVAL(Inp_char$,10)
650 IF Item<1 OR Item>Number THEN Item_select
660 OFF ERROR
670 !
680 CLEAR SCREEN
690 PRINT "Analysis Item: "&Title$(Item)
700 CALL Stat_ana(@Agt4287a,Item)
710 !
720 Prog_end: END
730 !=====
740 ! Statistical Analysis Function
750 !=====
760 SUB Stat_ana(@Agt4287a,INTEGER Item)
770 DIM Img1$(100),Img2$(100)
780 REAL Res(1:32,1:10)
790 INTEGER List_stat,Nop,I
800 !
810 OUTPUT @Agt4287a;":SOUR:LIST:STAT?"
820 ENTER @Agt4287a;List_stat
830 IF List_stat=1 THEN
840     OUTPUT @Agt4287a;":SOUR:LIST:SIZE?"
850     ENTER @Agt4287a;Nop
860 ELSE
870     Nop=1
880 END IF
890 !
900 FOR I=1 TO Nop
910     OUTPUT @Agt4287a;":CALC:EXAM:GET? ";Item;",";I
920     ENTER @Agt4287a;Res(I,1),Res(I,2),Res(I,3),Res(I,4),Res(I,5),
Res(I,6),Res(I,7),Res(I,8),Res(I,9),Res(I,10)
930 NEXT I
940 !
950 IF Nop>1 THEN
960     Img1$="3D,2X,MD.4DE,X,MD.4DE,X,MD.4DE,X,MD.4DE,X,MD.4DE"
970     Img2$="3D,2X,10D,2X,10D,2X,10D,2X,10D,2X,10D"
980     PRINT "      ----- Statistical Value for Normal Data -----
-----"
990     PRINT "Point      Mean          Sigma    3*Sigma/Mean Min.      Ma
x."
1000    FOR I=1 TO Nop
1010        PRINT USING
Img1$;I,Res(I,1),Res(I,2),Res(I,3),Res(I,4),Res(I,5)
1020    NEXT I
1030    PRINT ""
1040    PRINT "      ----- Occurrence Count -----
-----"
1050    PRINT "Point      Normal      Rdc Fail      Overload      Abnormal
All"
1060    FOR I=1 TO Nop
1070        PRINT USING Img2$;I,Res(I,6),Res(I,7),Res(I,8),Res(I,9),
Res(I,10)
1080    NEXT I
1090 ELSE
1100    OUTPUT @Agt4287a;":SOUR:LIST:POIN?"
1110    ENTER @Agt4287a;Meas_point
1120    PRINT "[ Point No. ";Meas_point;"]"
1130    PRINT "Statistical Value for Normal Measurement Data"
1140    PRINT " Mean          : ";Res(1,1)
1150    PRINT " Sigma          : ";Res(1,2)
1160    PRINT " 3*Sigma/Mean: ";Res(1,3)
1170    PRINT " Minimum        : ";Res(1,4)
1180    PRINT " Maximum        : ";Res(1,5)

```

Statistical Analysis of Measurement Results

Sample Program

```
1190     PRINT "Occurrence Count"
1200     PRINT " Normal      :";Res(1,6)
1210     PRINT " Rdc Fail   :";Res(1,7)
1220     PRINT " Overload   :";Res(1,8)
1230     PRINT " Abnormal   :";Res(1,9)
1240     PRINT " All        :";Res(1,10)
1250     END IF
1260 SUBEND
```

9**Saving and Recalling Files**

This chapter explains how to save or recall instrument settings and measurement results to or from a file.

Saving and Recalling Files

Specifying the file

When you save or recall a file, you must specify the file name with the extension. When you specify a file on the floppy disk drive, precede the file name with “A.”; when you specify a file under a directory, delimit the directory and file names with a slash (/).

Saving data to a file

You can use the following command to save the instrument setting, images on the LCD, measurement data for statistical analysis, list measurement results, and the contents of the setup table into a file:

- :MMEM:STOR on page 285

The contents to be saved depend on the extension of the filename and the parameters specified when the command is executed. The table below lists the extensions, parameters, and corresponding contents to be saved.

Extension	Parameter	Contents to be saved
.sta	Not needed	Instrument state (instrument settings, calibration and compensation state) are saved. For the instrument settings to be saved, see Appendix G, “Initial Settings.”
.bmp	Not needed	Images stored on the volatile memory ^{*1} are saved in the bitmap format. If no images exist on the clipboard, the images of the LCD are stored on the clipboard when the command is executed, then they are saved.
.csv	LOG or omitted	Measurement data for statistical analysis stored on the volatile memory (RAM) are saved in the ASCII format (as comma-delimited data). If the frequency of data measurement stored on the volatile memory exceeds 65,536, only the data acquired from the first 65,536 measurements are saved and the remaining data are ignored.
	LIST	Measurement results of list measurement at all measurement points are saved in the ASCII format as comma-delimited data. Measurement results of single-point measurement cannot be saved.
	SETup	The contents of all of the measurement point (stimulus) setup tables, the contents of all of the calibration kit setup tables, and the contents of all of the compensation kit setup tables are saved in the ASCII format as comma-delimited data.
	COMParator	The contents of all of the BIN sorting setup tables are saved in the ASCII format as comma-delimited data.
.dta	Not needed	Measurement data for statistical analysis stored on the volatile memory (RAM) are saved in the binary format. Regardless of how many times measurement is executed, all of the stored measurement data are saved.

*1. Images on the LCD when the [Capture] key ([Display] key) is pressed

Recalling a file

To recall an .sta file that contains previously saved instrument settings, use the following command:

- :MMEM:LOAD on page 284

By recalling an instrument settings file, you can restore the instrument to the state it was in when you saved the file. Note that some of the instrument settings cannot be saved.

Automatically recalling a file

When the 4287A is turned on, it looks for an instrument settings file named “autorec.sta” and, if the file exists, automatically recalls the settings from the file.

Managing a file

To manage files, use the following command:

Copies a file	:MMEM:COPY on page 283
Creates a new directory (folder)	:MMEM:CRE:DIR on page 283
Deletes an existing file or directory	:MMEM:DEL on page 284
Reads the following information about the storage device built in the 4287A	:MMEM:CAT? on page 282

Sample Program

Example 9-1 shows a sample program that demonstrates how to save data to a file. You can find the source file of this program, named `file_sav.bas`, on the sample program disk.

The sample program saves the selected type of data to the specified target file.

The program is described in detail below:

Line 40	Sets the GPIB address.
Lines 60 to 70	Retrieves the list/single-point (0/1) measurement setting and stores the setting into the <code>List_stat</code> variables.
Lines 80 to 90	Counts the data segments for statistical analysis that are residing on the volatile memory and stores the count into the <code>Point</code> variable.
Line 110	Allows the user to return to the entry start line and re-enter the data if an error (such as an invalid entry) occurs while selecting the type of data to save.
Lines 130 to 310	Displays the list of items that can be saved and prompts the user to choose one of the items by typing in the appropriate number.
Line 320	Converts the entered value into an integer and stores it into the <code>Content</code> variable.
Line 330	If <code>Content</code> is not within the valid range, the program returns the user to the entry start line.
Lines 360 to 630	Determines the file extension based on <code>Content</code> and stores the extension into the <code>Extension\$</code> variable. If the extension is “.csv,” determines the second parameter for the command to save and stores the parameter into the <code>Par\$</code> variable.
Line 650	Passes control to a subprogram named <code>Inp_file_name</code> , which lets the user input a file name without an extension, and then stores the returned file name into the <code>File\$</code> variable.
Lines 670 to 730	Saves the data and displays the name of the target file.

The `Inp_file_name` subprogram in lines 790 to 900, which is used to enter a save filename, is described below.

Line 810	Allows the user to return to the entry start line and re-enter the data if an error (such as an invalid entry) occurs while entering the target file name.
Lines 830 to 850	Prompts the user to enter the target file name. The program does not continue until the user actually enters the file name.
Lines 860 to 870	Displays the entered file name and waits for a confirmation entry (y/n key).
Line 880	Returns to the start line of input if any key other than the y key is pressed in response to line 870.

Example 9-1

File save (file_sav.bas)

```

10   DIM File$(300),Inp_char$(30),Extension$(9),Par$(9)
20   INTEGER List_stat,Point,Content,Max_no
30   CLEAR SCREEN
40   ASSIGN @Agt4287a TO 717
50   !
60   OUTPUT @Agt4287a;" :SOUR:LIST:STAT?"
70   ENTER @Agt4287a;List_stat
80   OUTPUT @Agt4287a;" :CALC:EXAM:MEM:POIN?"
90   ENTER @Agt4287a;Point
100  !
110  ON ERROR GOTO Content_select
120 Content_select: !
130  PRINT "## Save Content Selection ##"
140  PRINT "Select Content"
150  PRINT " 1: State"
160  PRINT " 2: Screen"
170  PRINT " 3: Setup Table"
180  PRINT " 4: Comparator"
190  Max_no=4
200  IF List_stat=1 THEN
210    PRINT " 5: List Measurement Results"
220    Max_no=Max_no+1
230  END IF
240  IF Point>1 THEN
250    PRINT " "&VAL$(Max_no+1)&": Data for Statistical Analysis
(ASCII)"
260    PRINT " "&VAL$(Max_no+2)&": Data for Statistical Analysis
(Binary)"
270    Max_no=Max_no+2
280  END IF
290  PRINT ""
300  PRINT "Input 1 to "&VAL$(Max_no)
310  INPUT "Number?",Inp_char$
320  Content=IVAL(Inp_char$,10)
330  IF Content<1 OR Content>Max_no THEN Content_select
340  OFF ERROR
350  !
360  SELECT Content
370    CASE 1
380      Extension$=".sta"
390    CASE 2
400      Extension$=".bmp"
410    CASE 3
420      Extension$=".csv"
430      Par$="SET"
440    CASE 4
450      Extension$=".csv"
460      Par$="COMP"
470    CASE 5
480      Extension$=".csv"
490      IF Max_no=5 OR Max_no=7 THEN
500        Par$="LIST"
510      ELSE
520        Par$="LOG"
530      END IF
540    CASE 6
550      IF Max_no=7 THEN
560        Extension$=".csv"
570        Par$="LOG"
580      ELSE
590        Extension$=".dta"

```

Saving and Recalling Files

Sample Program

```
600         END IF
610         CASE 7
620             Extension$=".dta"
630     END SELECT
640     !
650     CALL Inp_file_name(File$)
660     !
670     IF Extension$=".csv" THEN
680         OUTPUT @Agt4287a;":MMEM:STOR ""&File$&Extension$&""", "&Par$
690     ELSE
700         OUTPUT @Agt4287a;":MMEM:STOR ""&File$&Extension$&""
710     END IF
720     PRINT "## Done ##"
730     PRINT "Save file name: "&File$&Extension$
740     !
750     END
760     !=====
770     ! File Name Input Function
780     !=====
790     SUB Inp_file_name(Inp_name$)
800         DIM Inp_char$(9)
810         ON ERROR GOTO Inp_start
820     Inp_start: !
830         PRINT "## File Name Input ##"
840         PRINT "Input Save File Name (without Extension)"
850         INPUT "Name?", Inp_name$
860         PRINT "Input Name: "&Inp_name$
870         INPUT "OK? [Y/N]", Inp_char$
880         IF UPC$(Inp_char$)<>"Y" THEN Inp_start
890         OFF ERROR
900     SUBEND
```

Example 9-2 shows a sample program that uses the **:MMEM:CAT?** command to list information about the files. You can find the source file of this program, named `filelist.bas`, on the sample program disk.

Figure 9-1 shows an example of the listing resulting from execution of this program.

Figure 9-1

Example of the listing resulting from execution of this program

```
Used size: 276.50[MB] ( 289931264[Byte])
Free size: 798.22[MB] ( 836993024[Byte])
File information:
  Name                               Size[Byte]
=====
"\STATE1.STA"                       148616
"\STATE2.STA"                       148616
"\SCREEN.BMP"                       921654
```

Program details are listed below:

- Line 50 Set the GPIB address.
- Lines 70 to 80 Read information about the 4287A built-in storage and assign it to the `Disk_info$` variable.
- Lines 100 to 200 From the `Disk_info$` character string, fetch the already used capacity, free capacity, and file information (names and sizes) separated by commas (,) and then store them in the `Disk_data$(*)` array.
- Lines 240 to 250 Convert into the values in megabytes, the already used capacity and free capacity values in bytes that were read.
- Lines 260 to 390 List the information that was read.

Saving and Recalling Files

Sample Program

Example 9-2

File listing (filelist.bas)

```
10 DIM Disk_info$(25000),Disk_data$(1:500)[255],Img$(20)
20 REAL Used_size,Free_size,Used_size_m,Free_size_m
30 INTEGER Info_len,Loc,N,I
40 !
50 ASSIGN @Agt4287a TO 717
60 !
70 OUTPUT @Agt4287a;":MMEM:CAT?"
80 ENTER @Agt4287a;Disk_info$
90 !
100 Info_len=LEN(Disk_info$)
110 Loc=1
120 N=1
130 FOR I=1 TO Info_len
140 IF Disk_info$(I;1)="," THEN
150 Disk_data$(N)=Disk_info$(Loc,I-1)
160 Loc=I+1
170 N=N+1
180 END IF
190 NEXT I
200 Disk_data$(N)=Disk_info$(Loc,Info_len)
210 !
220 Used_size=VAL(Disk_data$(1))
230 Free_size=VAL(Disk_data$(2))
240 Used_size_m=Used_size/1048576 ! 1MB = 1024KB = 1048576Byte
250 Free_size_m=Free_size/1048576 ! 1MB = 1024KB = 1048576Byte
260 Img$="10A,4D.2D,6A,10D,7A"
270 PRINT USING Img$;"Used size:",Used_size_m,"[MB] (" ,Used_size,"[Byte])"
280 PRINT USING Img$;"Free size:",Free_size_m,"[MB] (" ,Free_size,"[Byte])"
290 PRINT "File information:"
300 IF N<3 THEN
310 PRINT "Nothing!!"
320 ELSE
330 PRINT " Name Size[Byte]"
340 PRINT "===== "
350 Img$="20A,2X,10D"
360 FOR I=3 TO N STEP 3
370 PRINT USING Img$;Disk_data$(I),VAL(Disk_data$(I+2))
380 NEXT I
390 END IF
400 !
410 END
```

10 **Error Handling**

This chapter explains how to handle errors that may occur in the Agilent 4287A while running a program.

Using the Error Queue

When an error occurs, its number and message will be stored in the error queue. Thus, you can determine which error has occurred by reading the contents of the error queue. Use the following command to read the contents of the error queue:

- `:SYST:ERR?` on page 298

You can also use the following command to check how many errors are contained in the error queue:

- `:SYST:ERR:COUN?` on page 298

Some examples of using the error queue are given below:

1. Use the error queue for branching control of the program in response to an error. If no error has occurred, the contents read out from the error queue are 0 for the number and “No error” for the message. This can be used to verify the occurrence of any error and is thus useful for the branch processing flow of your program. This is also used to handle a specific error that may be predefined in the program. This method, however, is not suitable for performing tasks synchronized with the occurrence of errors.
2. Use the error queue to identify an error that is detected via an SRQ (service request) (see Example 10-1).

Using the Status Reporting System

The status of the 4287A can be detected through the status registers. This section explains how to use the status registers to detect the occurrence of an error. For a complete description of the status report mechanism, including the specifications of each bit, see Appendix B, “Status Reporting System.”

Occurrence of an error will be reflected in the standard event status register. An SRQ is useful when you create a program that uses the information reported by this register to detect the occurrence of an error.

Use the following commands to detect the end of sweep via SRQ:

- *SRE on page 201
- *ESE on page 198

Follow these steps:

- Step 1.** Set the 4287A to generate an SRQ when “1” is assigned to one of the error occurrence bits of the standard event status register.
- Step 2.** Describe the program so that it executes interruption processing as soon as an SRQ is generated.

Figure 10-1

SRQ generation sequence (in response to an error)

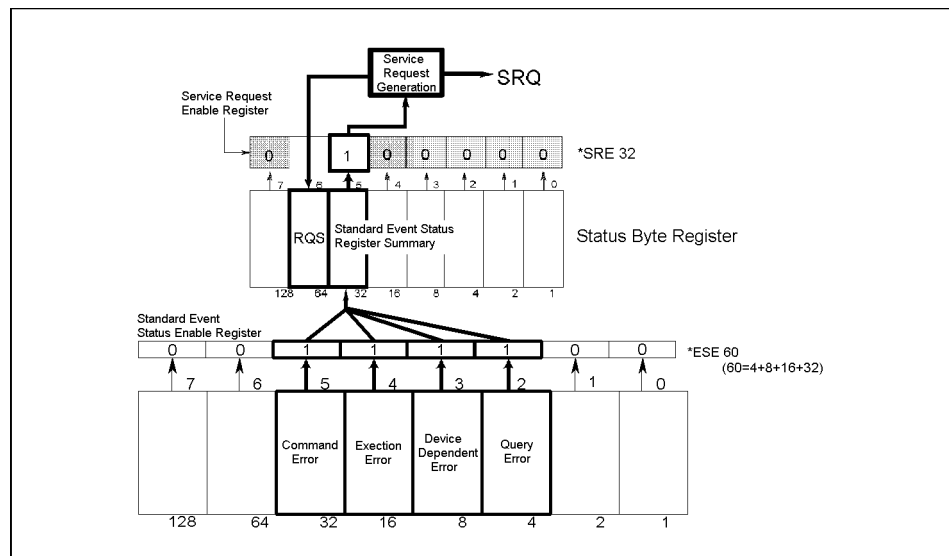

4287ape010

Sample Program

Example 10-1 is a sample program for detecting an error via an SRQ. This program is given the file name `srq_err.bas` and is stored on the sample program disk.

This program performs the necessary SRQ settings, intentionally sends a command that is not supported by the 4287A to cause an error, and then handles the error after it occurs. In the error handling, the error is identified and its error number and message are displayed followed by a message showing that the program is aborted.

Lines 40 to 50	Sets the GPIB address and select code.
Lines 70 to 80	Sets bits 2, 3, 4 and 5 of the standard event status register to be enabled and sets bit 5 of the service request enable register to 1.
Lines 90 to 110	Clears the status byte register, standard event status register, and error queue.
Lines 130 to 140	Sets the branch target for an SRQ interrupt to enable SRQ interrupts.
Lines 150 to 240	Sets measurement parameters 1 through 4, intentionally specifying an incorrect command for parameter 4 to cause an error.
Lines 270 to 280	Performs error handling. The number and message of the error are read out.
Lines 290 to 310	Displays a message showing that an error has occurred, the error number, error message, and another message indicating that the program is aborted.
Line 330	Displays a message for normal termination of the program. Note that this will not be displayed unless the program is modified to employ the appropriate command for measurement parameter 4.

Example 10-1 **Detecting an Error via an SRQ (srq_err.bas)**

```

10     DIM Buff$(9),Err_mes$(50)
20     INTEGER Scode,Err_no
30     !
40     ASSIGN @Agt4287a TO 717
50     Scode=7
60     !
70     OUTPUT @Agt4287a;"*ESE 60"
80     OUTPUT @Agt4287a;"*SRE 32"
90     OUTPUT @Agt4287a;"*CLS"
100    OUTPUT @Agt4287a;"*OPC?"
110    ENTER @Agt4287a;Buff$
120    !
130    ON INTR Scode GOTO Err_proc
140    ENABLE INTR Scode;2
150    OUTPUT @Agt4287a;":CALC:PAR1:FORM LS"
160    PRINT "Meas Para 1 Setting: Ls"
170    OUTPUT @Agt4287a;":CALC:PAR2:FORM RS"
180    PRINT "Meas Para 2 Setting: Rs"
190    OUTPUT @Agt4287a;":CALC:PAR3:FORM Q"
200    PRINT "Meas Para 3 Setting: Q"
210    OUTPUT @Agt4287a;":CALC:PAR4:FOR D"
220    PRINT "Meas Para 4 Setting: D"
230    OUTPUT @Agt4287a;"*OPC?"
240    ENTER @Agt4287a;Buff$
250    GOTO Skip_err_proc
260 Err_proc: OFF INTR Scode
270    OUTPUT @Agt4287a;":SYST:ERR?"
280    ENTER @Agt4287a;Err_no,Err_mes$
290    PRINT "Error occurred!!"
300    PRINT "  No: ";Err_no,"Description: "&Err_mes$
310    PRINT "PROGRAM INTERRUPT!!"
320    GOTO Prog_end
330 Skip_err_proc: PRINT "PROGRAM DONE."
340 Prog_end: END

```

Error Handling
Sample Program

11 Shutting Down the Instrument

This chapter explains how to shut down the Agilent 4287A.

Shutdown Procedure

When you use a GPIB command to shut down the Agilent 4287A, the power is turned off and the LED next to the standby switch goes off, but the standby switch remains in the ON (depressed) position. To shut down the 4287A, use the following command:

- :SYST:POFF on page 300

Issuing this command to shut down the 4287A causes the standby switch to remain in the ON (depressed) position. In this case, you can later turn on the power to the 4287A by one of the following two methods:

- Release the standby switch to the OFF position and then depress it to the ON position.
- Turn off the power to the 4287A and then turn on the power again. For example, you can disconnect the power cable from the rear panel and then reconnect it.

WARNING

After issuing the command shown above, be sure to wait until the LED beside the standby switch goes off to indicate that the 4287A is completely shut down. Do not turn off the power to the 4287A (or, if the 4287A belongs to a handler system, the power to that system) or disconnect the power cable from the rear panel while the LED is lit.

12 Connecting the Instrument to a Handler with the Handler Interface

You can use the handler interface of the Agilent 4287A to communicate with an external handler; for example, the 4287A can send end-of-measurement signals or bin-sorting results and receive external trigger or key lock signals. This chapter provides the information needed to set up an auto-sorting system that combines the 4287A with a handler by taking advantage of the handler interface and bin sorting.

Input/Output Signal Pin Layout

Figure 12-1 illustrates the layout of the input/output signal pins on the handler interface connector while Table 12-1 briefly describes these signals.

Figure 12-1

Handler Interface Connector Pin Layout

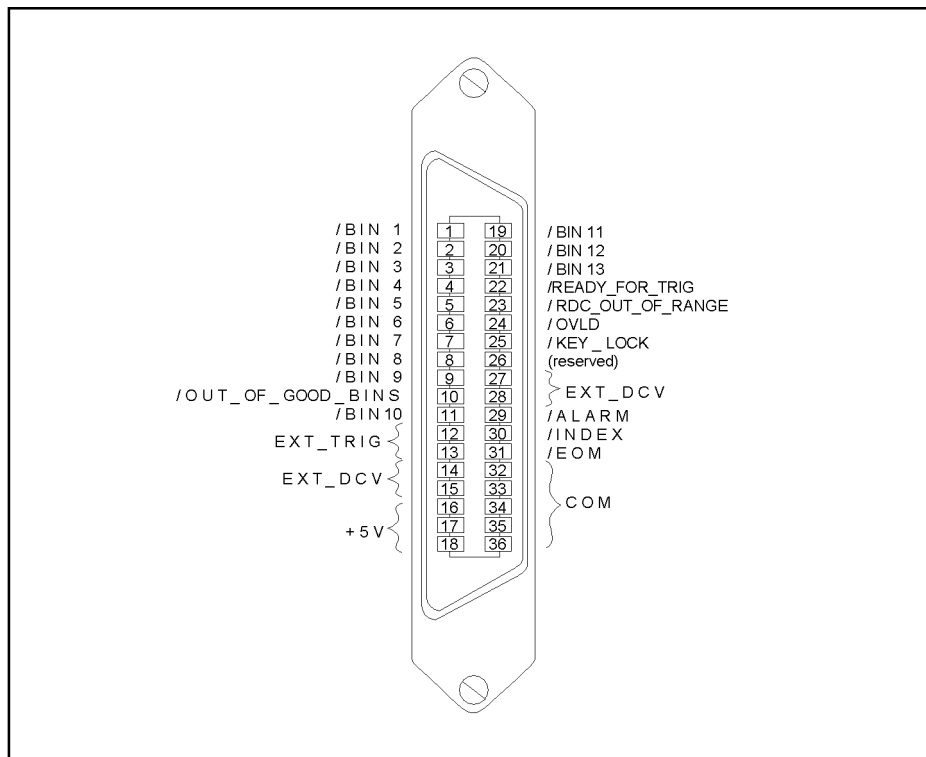

4287apj008

Table 12-1

Description of the handler Interface Input/Output Signals

Pin number	Signal name	Input/output	Description
1	/BIN1	Output	These signals indicate the result of sorting. When a DUT is sorted into a bin, the corresponding signal (one of pins 1 through 11 and 19 through 21) changes to the Low level. However, none of the signals changes to the Low level for a DUT that does not fall within the R_{dc} limit or cannot be measured (overload).
2	/BIN2		
3	/BIN3		
4	/BIN4		
5	/BIN5		
6	/BIN6		
7	/BIN7		
8	/BIN8		
9	/BIN9		
10	/OUT_OF_GOOD_BINS		
11	/BIN10		

Table 12-1

Description of the handler Interface Input/Output Signals

Pin number	Signal name	Input/output	Description
12, 13	EXT_TRIG	Input	An external trigger signal. Available when the trigger mode is set to Ext (external trigger source). The instrument is triggered when the pulse reaches a rising/falling* ¹ edge.
14, 15	EXT_DCV		External DC voltage. Supplies voltage necessary for driving input signals. The pin accepts input voltage within the range between +9 V and +15 V.
16, 17, 18	+5V	Output	Internal DC voltage.
19	/BIN11		These signals indicate the result of sorting. For more information, refer to the description of pins 1 through 11.
20	/BIN12		
21	/BIN13		
22	/READY_FOR_TRIG		The /READY_FOR_TRIG signal changes to the Low level when the instrument can be triggered. When the handler receives this signal, it can input an external trigger signal to the instrument.
23	/RDC_OUT_OF_RANGE		The /RDC_OUT_OF_RANGE signal changes to the Low level when the result of R _{dc} measurement does not fall within the specified limit range.
24	/OVL D		The /OVL D signal changes to the Low level when analog measurement cannot be performed (overload).
25	/KEY_LOCK	Input	Key lock signal. Changing this signal to the Low level locks the 4287A's front panel (keys and rotary knobs), keyboard, and mouse.
26	(Reserved).	—	Currently not in use. Leave this pin unconnected.
27, 28	EXT_DCV	Input	External DC voltage. For more information, refer to the description of pins 14 and 15.
29	/ALARM	Output	The /ALARM signal changes to the Low level when an alarm condition is detected; for example, when the instrument does not satisfy a self-test item, or a particular circuit malfunctions.
30	/INDEX		The /INDEX signal changes to the Low level when analog measurement is complete. When the handler receives the signal, it assumes that it is ready to connect the next DUT. However, no measurement data is available until the /EOM signal is received.
31	/EOM		The /EOM signal changes to the Low level when the instrument is ready to return measurement data and sort results after performing one complete cycle of measurement.
32, 33, 34, 35, 36	COM	—	Common for output signal pull-up voltage.

*1. The :TRIG:SLOP command on page 303 sets the polarity (rising or falling).

NOTE

A signal prefixed with a slash (/) is a negative logic signal (i.e., changes to Low when activated).

12. Connecting the Instrument with a Handler (Using the Handler Interface)

Outputting Bin Sort Results

When the bin sort feature is on (i.e., after you have issued the `:CALC:COMP` command on page 205 by specifying “ON”), the instrument outputs the result of bin sorting through the handler interface. Table 12-2 shows how bin sort results are mapped to the sort result signals `/BIN1` through `/BIN13` and `/OUT_OF_GOOD_BINS` of the handler interface. The table assumes that you have issued the `:CALC:COMP:OGB` command on page 217 by specifying 10 so that bins 1 through 10 serve as good bins while bins 11 through 13 serve as bad bins.

NOTE

When the bin sort feature is off, the instrument does not output signals except the `/INDEX`, `/EOM`, `/ALARM`, `/OVLD` and `/READY_FOR_TRIG`. The `EXT_TRIG` is valid regardless of the on/off status of the bin sort feature if the trigger mode is set to External. The `/KEY_LOCK` is also valid regardless of on/off status of the bin sort feature.

Table 12-2

Mapping between Bin Sort Results and Handler Interface Output Signals

Measurement status	Bin sort results		Handler interface signal(s) that is (are) activated	GPIB output		
				Measurement status	Measured value	Bin sort result
Normal	Indicates a DUT that was not sorted into any of bins 1 through 13		/OUT_OF_GOOD_BINS	0	Measured value	0
	Good bin *1	BIN1	/BIN1			1
		BIN2	/BIN2			2
		BIN3	/BIN3			3
		BIN4	/BIN4			4
		BIN5	/BIN5			5
		BIN6	/BIN6			6
		BIN7	/BIN7			7
		BIN8	/BIN8			8
		BIN9	/BIN9			9
		BIN10	/BIN10			10
	Bad bin *1	BIN11	/BIN11, /OUT_OF_GOOD_BINS			11
		BIN12	/BIN12, /OUT_OF_GOOD_BINS			12
BIN13		/BIN13, /OUT_OF_GOOD_BINS		13		
Overload*2	Sort failure	/OVLD	1	9.9E37	14	
R _{dc} out of range		/RDC_OUT_OF_RANGE	2	Measured value *3		
Simultaneous detection of overload and R _{dc} out of range		/OVLD, /RDC_OUT_OF_RANGE	3	9.9E37		

- *1. This table assumes that you have issued the :CALC:COMP:OGB command on page 217 by specifying 10 so that bins 1 through 10 serve as good bins while bins 11 through 13 serve as bad bins.
- *2. When overload is detected at a measurement point that is not used for bin sorting, bin sorting is operated normally. Therefore the bin sort result is not 14 in this case.
- *3. The instrument outputs a measured value normally. However, the output may be an invalid value that was measured while there was a bad contact.

12. Connecting the Instrument with a Handler (Using the Handler Interface)

Timing Chart

The timing chart in Figure 12-2 shows the timing and duration of each handler signal. During the interval where /DATA is unknown, no output signal is available because the 4287A is processing the result of analog measurement. For the meanings of T1 through T7 in this chart, see “Specifications and Supplemental Performance Characteristics” in *Operation Manual*.

NOTE

Design a handler-based auto-sorting system so that the measurement cycle must be synchronized with the operation status of the 4287A using the status report system or the timing signals (/READY_FOR_TRIG, /INDEX, or /EOM). Don't synchronize by inserting a wait time in the control program for a handler-based auto-sorting system.

Figure 12-2 Handler interface timing chart

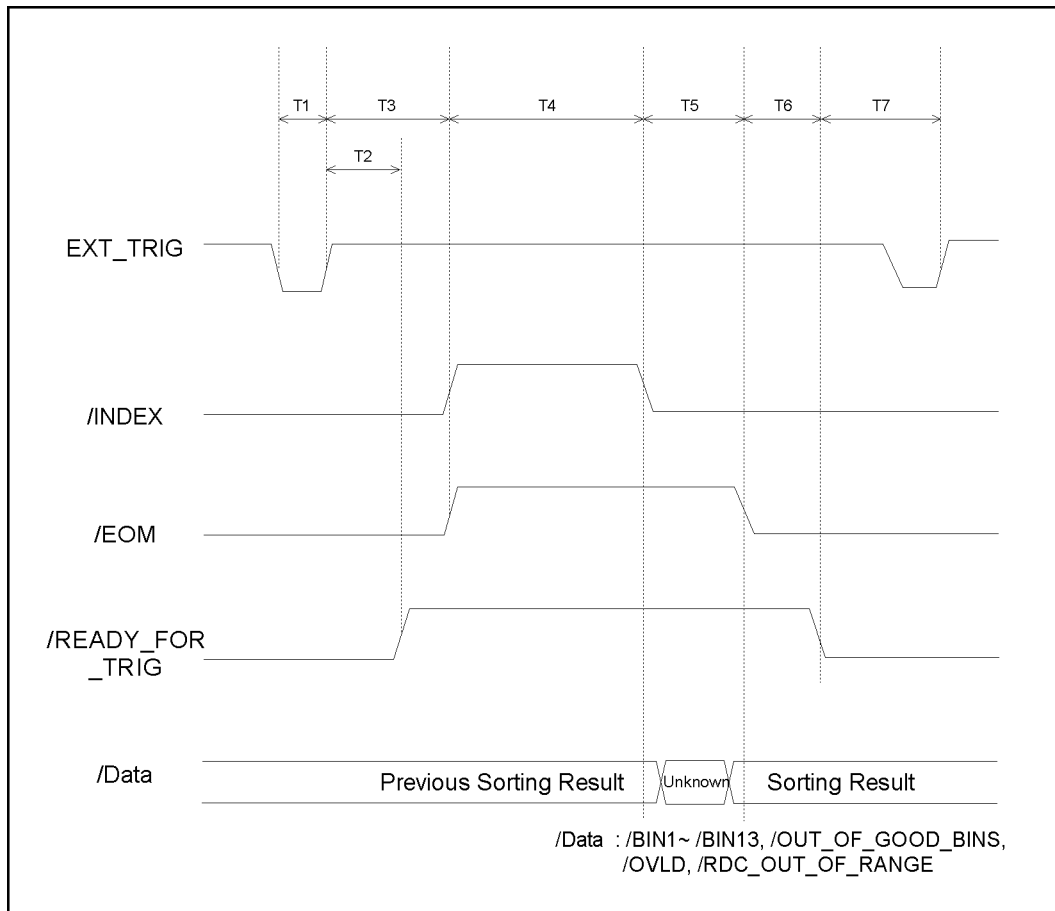

4287ape009

Electrical Characteristics

Output signals

Each output signal is generated as open collector output of a photocoupler and obtained as voltage output applied to an external pull-up resistor connected to the 4287A (Table 12-4). Table 12-3 shows the electrical characteristics of the output signals. A typical circuit diagram for the handler output signals (an example of pull-up resistor connections) is shown in Figure 12-3.

Table 12-3

Electrical characteristics of handler interface output signals

Output voltage [V]		Maximum current [mA]
Low	High	
0 to 0.5	Pull-up voltage (5 to 24)	6

Table 12-4

Guidelines for pull-up resistance values

Pull-up voltage [V]	Resistance value [Ω]	Typical resistors	
		Resistance value [Ω]	Agilent Part No.
5	1.7k (5 V / 3 mA)	1.78k	0757-0278
9	3.0k (9 V / 3 mA)	3.16k	0757-0279
12	4.0k (12 V / 3 mA)	4.22k	0698-3154
15	5.0k (15 V / 3 mA)	5.11k	0757-0438
24	8.0k (24 V / 3 mA)	8.25k	0757-0441

The 4287A can also contain internal pull-up resistors. For more information, contact your distributor or the Agilent Technologies sales office nearest your site.

Connecting the Instrument to a Handler with the Handler Interface
Electrical Characteristics

Figure 12-3 Circuit diagram for handler interface output signals

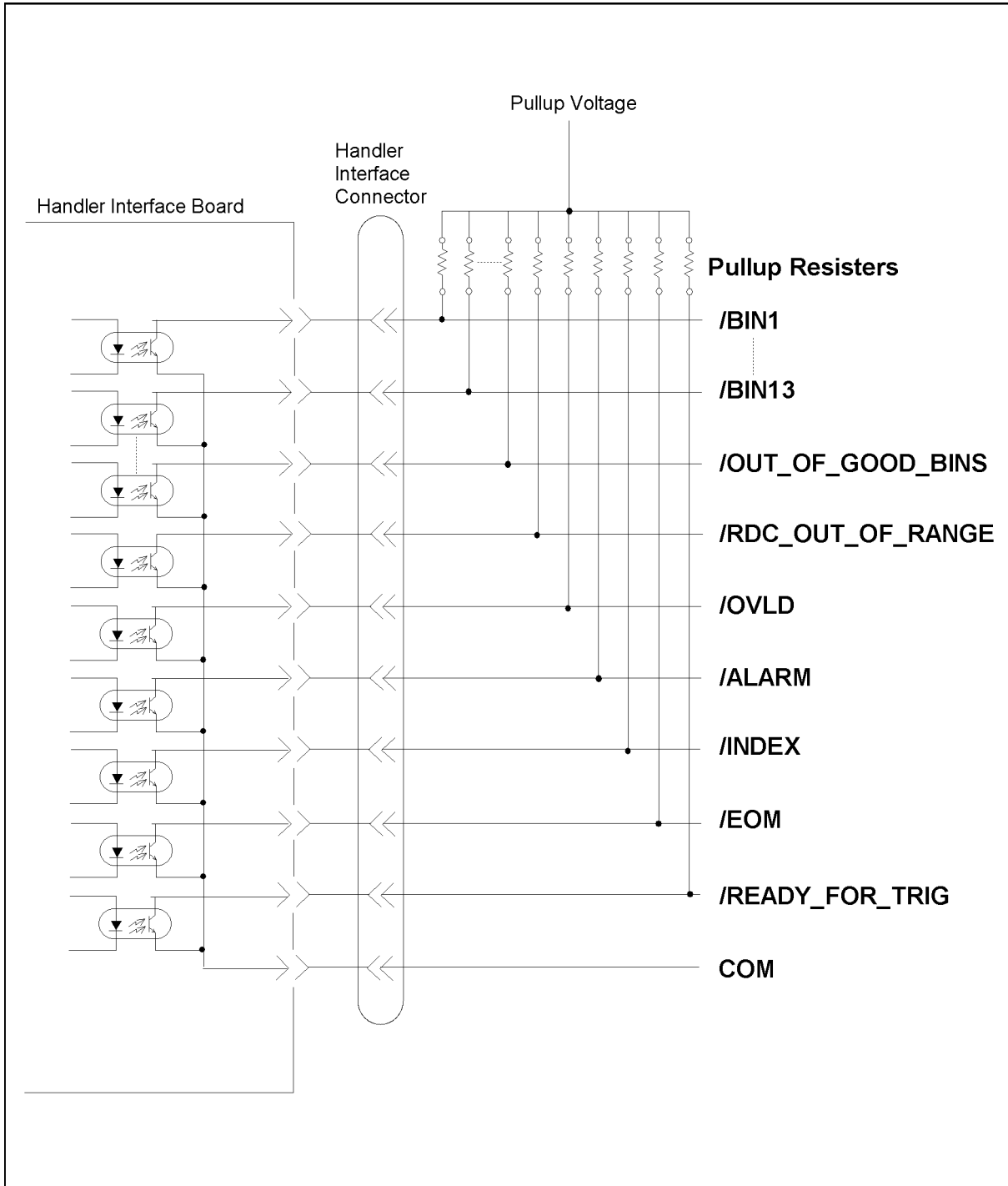

Input signals

Each input signal is connected to a photocoupler's LED (cathode side). The LED (anode side) is connected with drive voltage (EXT_DCV). Table 12-4 shows the electrical characteristics of the input signals. Figure 12-4 also shows the circuit diagram for the input signals. The amperage of the current fed through the LED depends on the drive voltage.

Table 12-5

Electrical characteristics of handler interface input signals

Input Signals	Input voltage [V]		Input current (at Low level) [mA] (typical value)	
	Low	High	When drive voltage = 12 V	When drive voltage = 15 V
EXT_TRIG	0 to 1	Drive voltage (EXT_DCV)	4.6	5.9
/KEY_LOCK			14	18

Figure 12-4

Circuit diagram for handler interface input signals

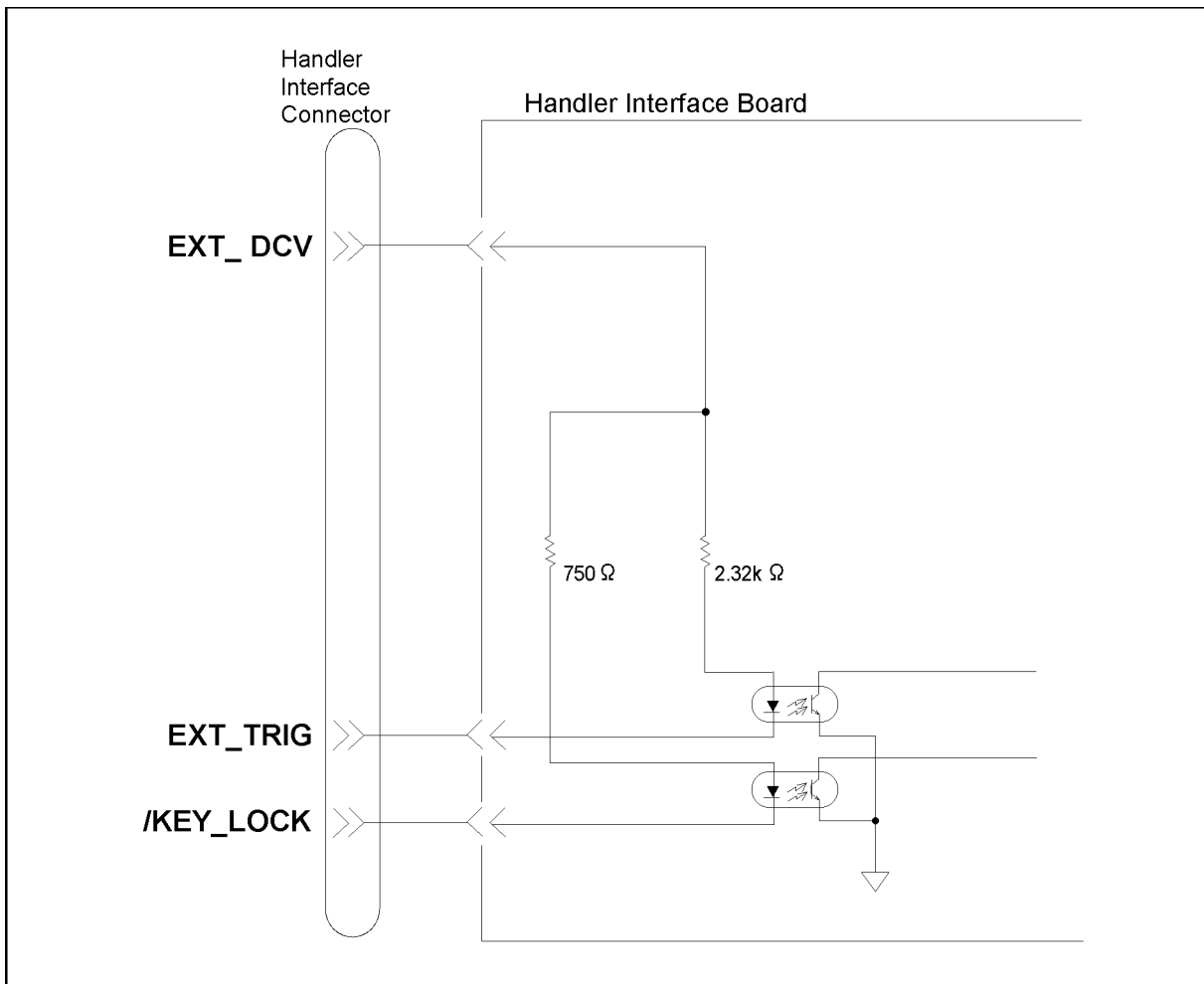

4287ape006

12. Connecting the Instrument with a Handler (Using the Handler Interface)

Output signal pull-up/input signal drive voltage

The following table shows the valid range for each of the output signal pull-up voltage and input signal drive voltage (EXT_DCV).

Table 12-6

Valid ranges for output signal pull-up/input signal drive voltage

	Valid voltage range [V]
Output signal pull-up voltage	5 to 24
Input signal drive voltage	9 to 15

The 4287A can be modified so that the input drive voltage can be used within the range between 5 V and 9 V or 15 V and 24 V or so that the output signal pull-up voltage and input signal drive voltage can be connected to the 4287A's internal 5 V power supply. For more information, contact your distributor or the Agilent Technologies sales office nearest your site.

Modification of the Handler Interface

This section explains how to make the following modifications to the inside of the instrument:

- Setting the drive/pull-up power supply between 5 V and 9 V or 15 V and 24 V.
- Mounting the pull-up resistors on the inside of the instrument.

NOTE

The information given here is designed for Agilent Technologies service centers.

Setting the drive/pull-up power supply

The drive/pull-up power supply is set by using the jumper (J5) and DIP switch (S1) on the A23 Handler Interface Board. For the location and socket numbers of J5 and the location and switch numbers of S1, refer to Figure 12-5.

Figure 12-5

A23 Handler Interface Board

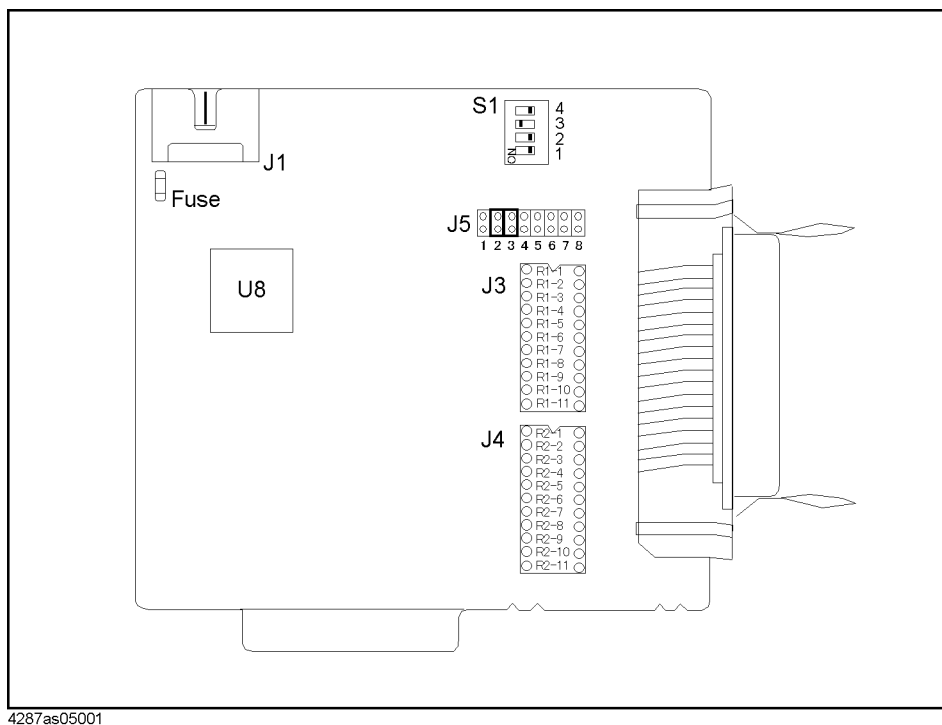

Connecting the Instrument to a Handler with the Handler Interface Modification of the Handler Interface

Setting the jumper (J5)

J5 lets you set the output signal pull-up and input signal drive power supply and its common. Setting one of the following jumpers selects external power supply (EXT_DCV) or internal power supply (+5 V).





Socket number	Power supply setting when the jumper is set (shorted)	Factory setting
J5-1	For the output signal pull-up and input signal drive power supply, internal power supply (+5 V) is specified.	Open
J5-2	For the output signal pull-up and input signal drive power supply, external power supply (EXT_DCV) is specified.	Short
J5-8	Short external common of handler interface to internal common of 4287A.	Open

NOTE Set (short) only one from among J5-1 and J5-2. Do not set (short) two at the same time.

NOTE J5-3, J5-4, J5-5, J5-6, and J5-7 are not used at present. Do not connect anything to them.

Setting the switches (S1)

Each switch of the DIP switch (S1) must be set as follows, depending on the voltage setting of the output signal pull-up and the input signal drive power supply (DCV).

Voltage setting of output signal pull-up and input signal drive power supply (DCV)			
$5V \leq DCV \leq 6V$	$6V < DCV \leq 9V$	$9V < DCV \leq 15V$	$15V < DCV \leq 24V$
		(factory setting) 	

Setting the pull-up resistors

The pull-up resistors for the output signals can be set using J3 and J4 on the A23 handler interface board. Figure 12-6 shows the location of the pull-up resistors on the circuit diagram where the resistor for each signal should be mounted. The location on the handler interface board is shown in Figure 12-5. Refer to Table 12-4 for typical resistance values.

NOTE The resistors are not factory-mounted.

NOTE R2-5 and R2-8 are reserved; do not connect anything to them.

Figure 12-6 Pull-up resistor setting on handler interface board

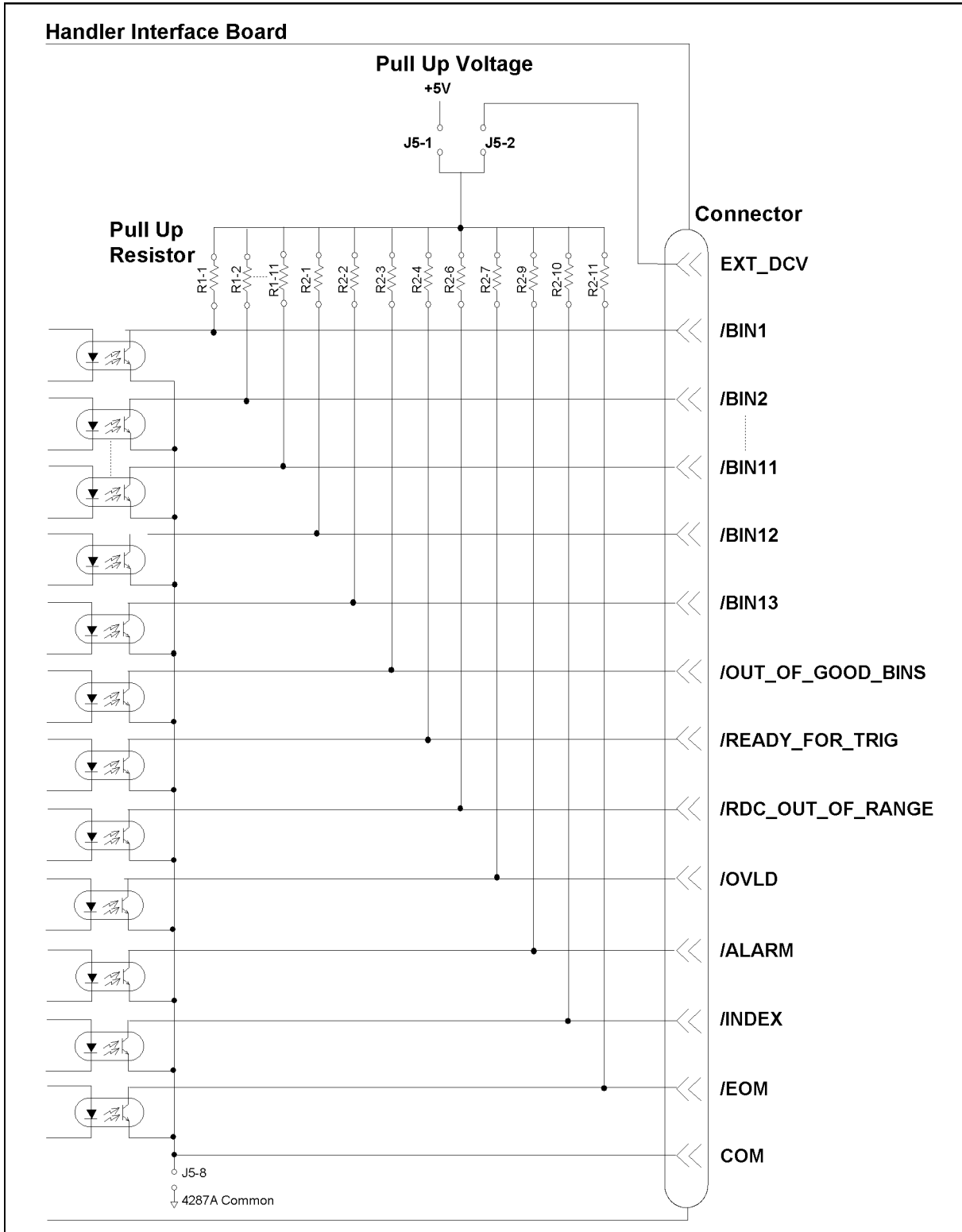

12. Connecting the Instrument with a Handler (Using the Handler Interface)

Procedure for removing the handler interface board

This section describes how to remove the handler interface board when setting the drive/pull-up power supply or mounting the pull-up resistors.

WARNING

Allow at least 10 minutes to elapse after disconnecting the power cable before performing this work. While the 4287A is operating or immediately after the power is turned off, dangerous electrical energy or voltage exists. Therefore, sufficient time is required after disconnecting the power cable to discharge the internal capacitor.

NOTE

While removing the cover, setting the drive/pull-up power supply, and mounting the pull-up resistors, be sure to perform the work in an area with static protection and to wear a ground strap.

- Step 1. Disconnect power cable and wait for 10 minutes.
- Step 2. Remove side straps from both sides of the 4287A.
- Step 3. Turn the 4287A upside-down.
- Step 4. Remove the eight screws and four feet from the bottom of the 4287A .
- Step 5. Turn the 4287A rightside-up to its normal position.
- Step 6. Remove the six screws (item 1 in Figure 12-7) and four standoffs (item 2 in Figure 12-7) from the rear panel.

Figure 12-7

4287A Rear Panel

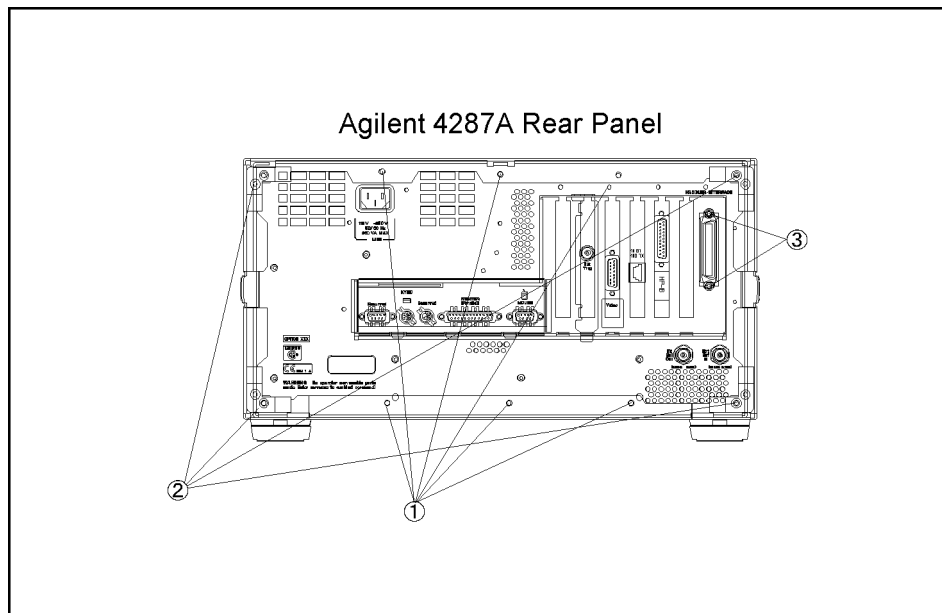

4287ase06002

- Step 7. Remove the two screws securing the A32 handler interface (item 3 in Figure 12-7) from the rear panel.
- Step 8. Slide the cover toward the back to remove it.

- Step 9.** Disconnect the flat cable from the A23 handler interface board. For the location of the A23, see Figure 12-8

Figure 12-8

4287A Top View

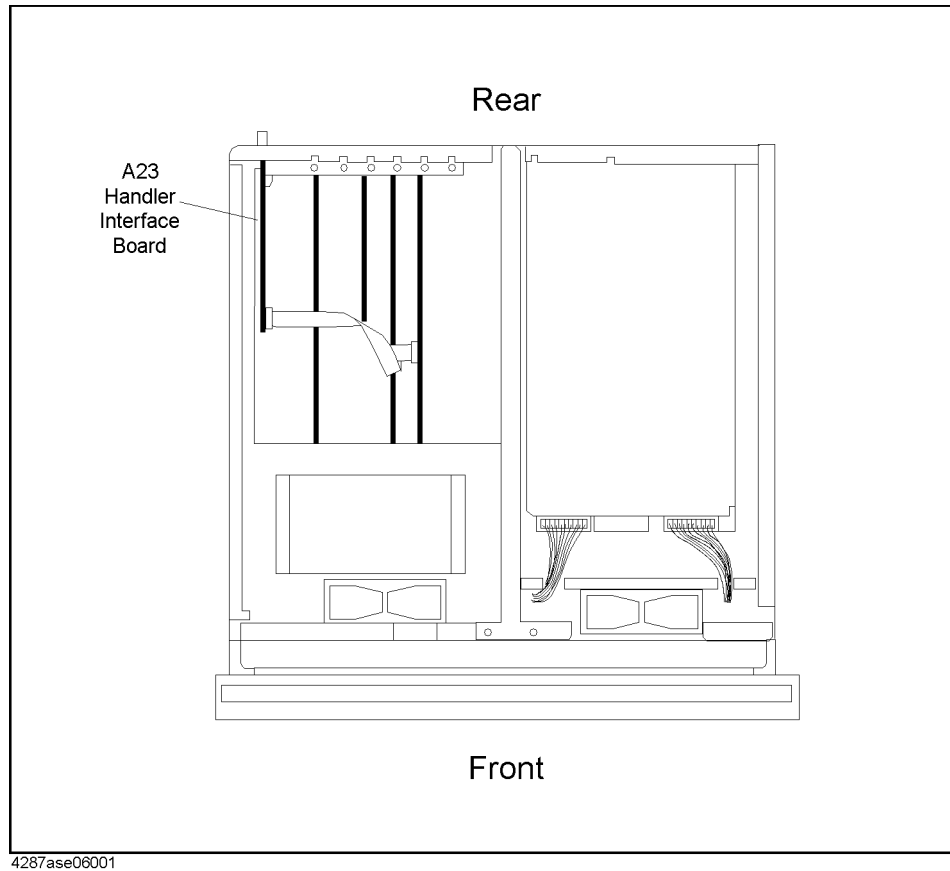

12. Connecting the Instrument with a Handler (Using the Handler Interface)

- Step 10.** Gently pull the A23 handler interface board upward and out.

13 Using LAN

This chapter describes LAN (Local Area Network)-based file transfer and remote control.

Advantages of LAN Connections

You can connect the Agilent 4287A to a LAN, which allows you to take advantage of several additional functions:

- You can transfer files in the 4287A to an external computer, or vice versa, without having to use floppy disks.
- You can use an external computer, regardless of whether it's equipped with a GPIB interface card, to interactively send GPIB commands to the 4287A, thereby achieving simple remote control.

NOTE

Programs cannot control the 4287A through LAN connections.

Preparing to Use a LAN

Setting up LAN connections

Before connecting the instrument to a LAN, you need to set an IP address (a unique address assigned to a device to uniquely identify it over the LAN), a gateway IP address (the IP address of a routing device that connects the LAN to other physical networks), a sub-net mask (a numerical value used to determine whether to route communications through the gateway), and a computer name (a unique name assigned to a device to identify it over the LAN).

NOTE Obtain the proper settings for IP address, gateway address, sub-net mask, and computer name from your network administrator.

NOTE If your network does not need to be connected to devices on different physical networks, you usually do not need to set the gateway IP address or the sub-net mask.

NOTE For your specified IP address, gateway IP address, sub-net mask, and computer name to take effect, you need to reboot the 4287A (turn it off and back on).

Setting the IP address, gateway IP address, and sub-net mask







Set these items by referring *configuring the network* of the *chapter 11 in Operation Manual*.

Using LAN

Preparing to Use a LAN

Setting the computer name







To set the computer name, follow these steps:

- Step 1.** Press the **[System]** key on the front panel.
- Step 2.** From the softkey menu along the right-hand edge of the screen, select (highlight) the softkey labeled **LAN SETUP** by pressing the  or  key. Then press the  key.
- Step 3.** From the softkey menu along the right-hand edge of the screen, select (highlight) the softkey labeled **COMPUTER NAME** by pressing the  or  key. Then press the  key.
- Step 4.** A window appears that lets you enter the computer name. Use the  key or mouse to set the computer name.

Connecting to a LAN

Enabling/disabling the LAN port

Before connecting the 4287A to a LAN, make sure that the LAN port on the rear panel is enabled. To enable/disable the LAN port, follow these steps:

- Step 1.** Press the **[System]** key on the front panel.
- Step 2.** From the softkey menu along the right-hand edge of the screen, select (highlight) the softkey labeled **LAN SETUP** by pressing the  or  key. Then press the  key.
- Step 3.** If the **NETWORK DEVICE []** softkey label displays **ENABLE** between the square brackets ([]), the LAN port is already enabled; in this case, leave the current setting unchanged. If the softkey label displays **DISABLE** between the square brackets ([]), select (highlight) the **NETWORK DEVICE []** softkey label using the  or  key and then press the  key.

NOTE

It takes more than 10 seconds for the new setting to take effect. Therefore, if you have changed the setting from **DISABLE** to **ENABLE**, you should wait at least 20 seconds before using the LAN connection. However, if the LAN port was disabled when the 4287A was turned on, you must wait at least 20 seconds after changing the setting and then reboot the 4287A before using the LAN connection.

Connecting cables

Connect the LAN port (RJ-45 connector) in the lower left area of the 4287A's rear panel to an available port on your LAN with a 10Base-T twisted pair (Ethernets) cable.

Transferring Files

You can use FTP (file transfer protocol) to transfer files from the 4287A to an external computer connected to the same LAN or vice versa.

NOTE

The description given below assumes that you are familiar with basic operations in a Windows environment, such as Windows 98 or Windows NT and that you have basic knowledge of MS-DOS operation. For more information on Windows 98 or other Windows operating systems, see the appropriate documentation.

File transfer procedure using ftp

A file transfer procedure that uses ftp (an FTP-based file transfer program) is described here through a simple example in which a file named “file_ins.sta” on an external computer running a Windows operating system is transferred to the non-volatile memory of the 4287A (IP address: 192.168.0.1, host name: 4287a) while a file named “ex_ins.sta” in the flash memory of the 4287A is transferred to the external computer.

NOTE

You cannot establish more than one ftp connection at a time. If your 4287A is already connected through ftp, do not perform the following procedure until the existing connection is disconnected.

- Step 1.** Start up the external computer's screen to show the MS-DOS prompt.
- Step 2.** Move to the directory where file_com.sta resides.
- Step 3.** At the MS-DOS prompt, type either “ftp 192.168.0.1” or “ftp 4287a” and press the Return key.
- Step 4.** Press the Return key once to bring up the ftp prompt.

NOTE

The file system of the 4287A is provided with neither user name protection nor password protection. Therefore, you can login with any user name and no password for the account.

- Step 5.** Type “binary” at the ftp prompt and press the Return key. This step sets the file transfer mode to binary format.

NOTE

Choose the file transfer mode to conform with the file you transfer. That is, you should use the ASCII format for .csv files, or the binary format for any other file types.

- Step 6.** Type “put file_com.sta” at the ftp prompt and press the Return key. This completes the transfer from an external computer to the 4287A.
- Step 7.** Move to the directory where file_ins.sta resides.

NOTE

You cannot move to a directory whose name contains one or more spaces.

- Step 8.** Type “get file_com.sta” at the ftp prompt and press the Return key. This completes the transfer from an external computer to the 4287A.

Using LAN Transferring Files

Step 9. Type “quit” at the ftp prompt and press the Return key to quit the ftp session.

Ftp commands

This section briefly describes commands that are frequently used in ftp transfer.

get	Transfers (copies) a specified file from the current directory of the ftp server (the 4287A in the example above) to the ftp client (an external computer in the example above).
put	Transfers (copies) a specified file from the ftp client to the ftp server's current directory.
binary	Sets file transfer mode to binary format.
ascii	Sets file transfer mode to ASCII format.
cd	Changes the current directory.
dir	Lists the contents of the current directory.
quit	Quits the ftp session.

File transfer procedure using a file transfer application

Using a file transfer application in a Windows environment allows you to easily transfer files by mouse operations. A general procedure for using such an application is briefly given below.

Step 1. Start up a suitable file transfer application. A screen showing the status before connecting the 4287A (for example, Figure 13-1) appears.

Figure 13-1

Sample screen of file transfer application (before connecting 4287A)

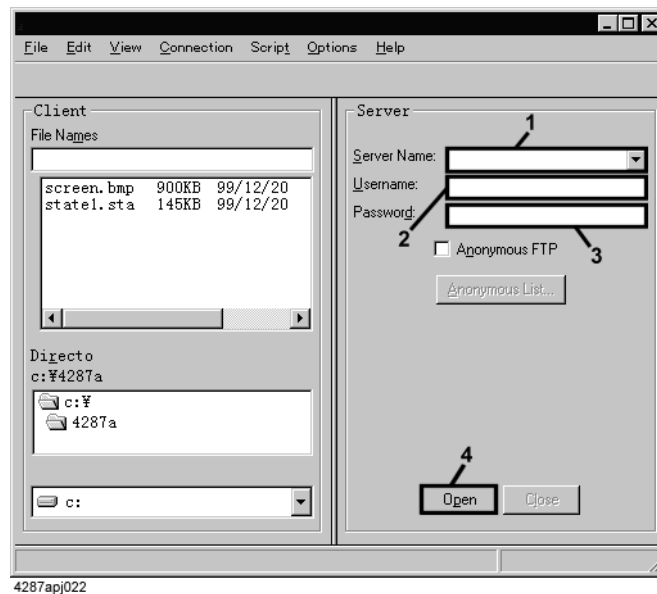

Step 2. Enter the IP address of the 4287A in the Server Name field (the field labeled 1 in Figure 13-1) and then enter suitable character(s) (any character(s) other than space(s)) in the User Name field (the field labeled 2 in Figure 13-1). You can leave the Password field (the field labeled 3 in Figure 13-1) blank.

Step 3. To start a connection with the server (the 4287A), click the button labeled 4 in Figure 13-1, and then the contents of the file system of the 4287A appear as shown in Figure 13-2.

Figure 13-2

Sample screen of file transfer application (after connecting 4287A)

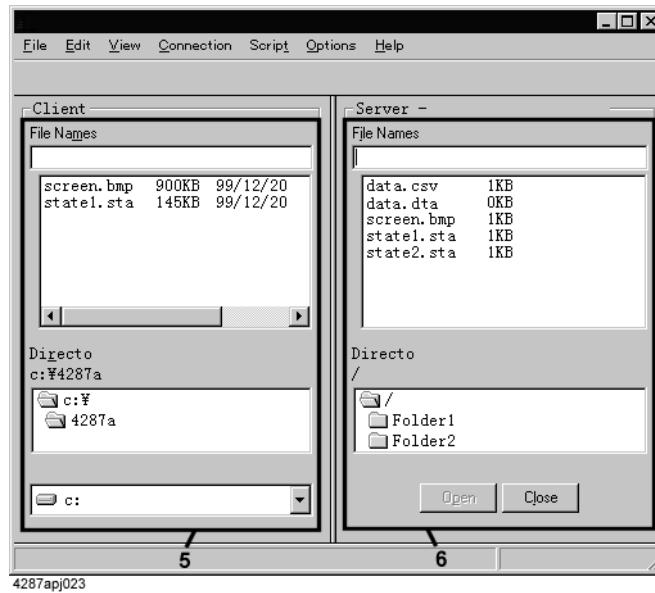

Step 4. Copy files using standard procedures for copying files within Windows 98 Explorer, from the external computer side (the window labeled 5 in Figure 13-2) to the 4287A side (the window labeled 6 in Figure 13-2), or from the 4287A side to the external computer.

Interactive Control by Telnet

When connected to a LAN, the 4287A supports interactive control that uses telnet (an interface program for the telnet protocol).

A control procedure that uses telnet is described below through a simple example in which the 4287A (IP address: 192.168.0.1, host name: 4287a) is controlled from an external computer running a Windows operating system.

- Step 1.** Start up the external computer's screen to show the MS-DOS prompt.
- Step 2.** At the MS-DOS prompt, type either "telnet 192.168.0.1" or "telnet 4287a" and press the Return key.
- Step 3.** After the telnet terminal window opens, the computer connects to the 4287A, and the terminal window shows a welcome message as shown in Figure 13-3. (In a UNIX environment, a welcome message appears under the line in which you typed "telnet 192.168.0.1".)

Figure 13-3

Sample screen of telnet-based control (immediately after connection)

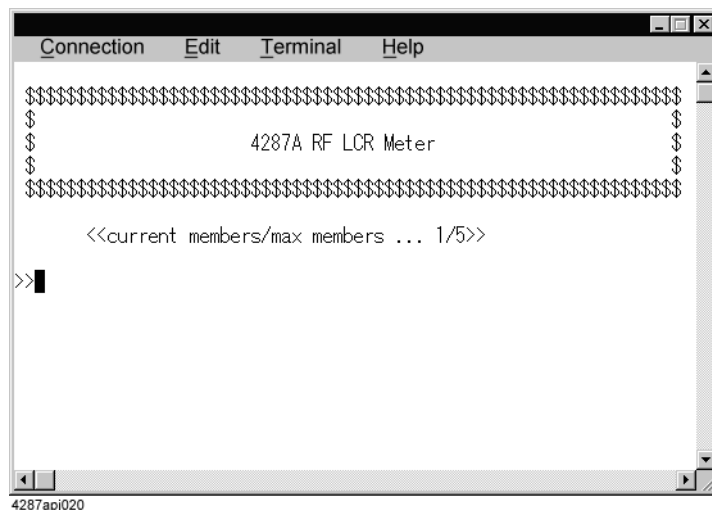

- Step 4.** Enter a command below the welcome message and press the Return key. The command is then sent to the 4287A, where it is actually executed. Also, when you type a Query command and press the Return key, the Query response appears below the line where you entered the command. For example, if you reset the instrument using the :SYST:PRES command on page 300 and set measurement parameters 1 and 2 to Ls and Q using the :CALC:PAR{1-4}:FORM command on page 224, you would be presented with a screen like Figure 13-4 after the settings have been accepted.

NOTE

If each character you have entered appears twice, disable the local echo feature of your telnet program. Note that local echo is a feature that echoes entered characters on screen.

Figure 13-4 Sample screen of telnet-based control (immediately after command execution)

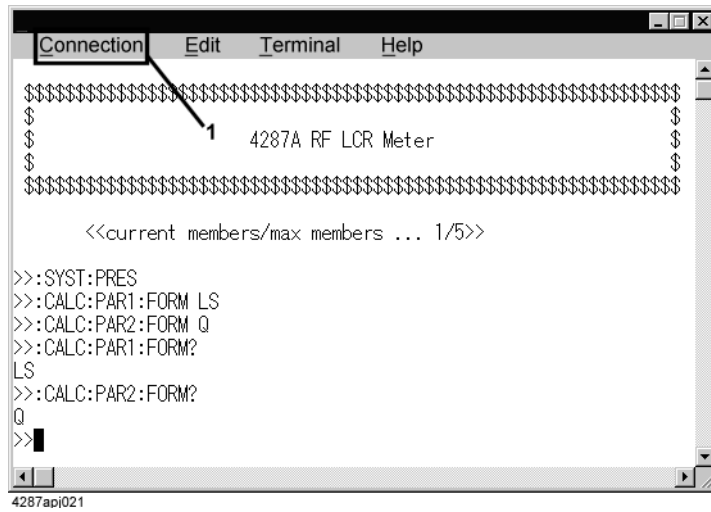

- Step 5. The Connection menu (labeled 1 in Figure 13-4) of the telnet terminal window allows you to break the connection with the 4287A and quit the telnet session. (In a UNIX environment, typing the] key while holding down the Control key causes the telnet prompt to appear, where you can type quit to break the connection with the 4287A and quit the telnet session as well.)

Using LAN
Interactive Control by Telnet

14 Sample Application Programs

This chapter provides sample measurements (sample programs).

Measuring the DUT with a Test Fixture

Example 14-1 is a sample program that demonstrates how to measure a chip component with a test fixture. You can find the source file of this program, named `meas_fxt.bas`, on the sample program disk.

Start the program after mounting the test head on the fixture stand and connecting it to the Agilent 4287A. When you are prompted with the message “Set Open-Connection,” connect the OPEN standard to the test head’s 7 mm terminal and press the **[y]** key followed by the **[Enter]** key to obtain the OPEN measurement data for calculating the calibration coefficients. Repeat the same steps to obtain the SHORT, LOAD, and LOW LOSS CAPACITOR data for calculating calibration coefficients.

When the instrument has finished measuring the data for calculating the calibration coefficients, the program prompts you to select the test fixture. Enter the number that corresponds to the test fixture you want to use and then press the **[Enter]** key. When you are presented with the message “Set Open-Connection,” connect the test fixture to the test head and set up the test fixture for OPEN measurement. Then, press the **[y]** key followed by the **[Enter]** key to obtain the OPEN measurement data for calculating the compensation coefficients. When the “Set Short-Connection” message appears, repeat the same steps to obtain the SHORT measurement data for calculating the compensation coefficients.

NOTE

For more information on using the test fixture, including how to set it up for OPEN and SHORT measurements, refer to the test fixture’s manual.

When the instrument has finished measuring the data for calculating the compensation coefficients, the program displays the message “Set DUT, then Push [Enter] key.” Mount the DUT on the test fixture and press the **[Enter]** key. Then the instrument measures the DUT and displays the results. After displaying the measurement results, the program displays the message “Once more? [Y]es/[N]o.” If you want to measure the DUT again or measure another DUT, press the **[y]** key followed by the **[Enter]** key to continue the measurement session. If you want to quit the measurement session, press any key except **[y]** and **[Enter]**.

The program is described in detail below:

Lines 70 to 80	Sets the GPIB address and select code.
Lines 120 to 140	Stores the active table number (No.1), the unit of the signal source level (mA), and the number of measurement points (4 points) into the <code>Act_tab</code> , <code>Unit\$</code> , and <code>Nop</code> variables, respectively.
Lines 150 to 260	Stores the frequency, averaging factor, and signal source level at each point into the <code>Freq(*)</code> , <code>Ave(*)</code> , and <code>Pow(*)</code> arrays, respectively. The <code>Freq(*)</code> array contains four values of 100 MHz, 800 MHz, 1 GHz, and 3 GHz; the <code>Ave(*)</code> array contains “1” for all points; the <code>Pow(*)</code> array contains “0.2 mA” for all points.
Lines 270 to 300	Stores the parameter settings for measurement parameters 1 through 4 into the <code>Para\$(*)</code> array so that it contains <code>Ls</code> , <code>Q</code> , <code> Z </code> , and <code>Rs</code> .
Lines 290 to 320	Stores the R_{dc} measurement lower limit for the OPEN standard (100 Ω) into the <code>Open_1_lim</code> variable; the R_{dc} measurement upper limit for the SHORT standard (25 Ω) into the <code>Short_u_lim</code> variable; the R_{dc} measurement lower and upper limits for the LOAD standard (25 Ω and

	100 Ω) into the Load_l_lim and Load_u_lim variables, respectively.
Line 410	Resizes the Res array based on the value of the Nop variable.
Lines 450 to 460	Resets the instrument and sets the data transfer format to ASCII.
Lines 470 to 480	Sets the active table number to Act_tab and the unit of the signal source level to Unit\$.
Lines 490 to 530	Configures the measurement point setup table.
Line 540	Turns on list measurement.
Lines 560 to 580	Sets measurement parameters 1 through 4 to Para\$(1) through Para\$(4).
Line 620	Configures the instrument to use the 4287A Option 007 (16195B 7-mm calibration kit).
Lines 640 to 750	Passes control to a subprogram named FNCal, which measures the data for the OPEN, SHORT, LOAD, and LOW LOSS CAPACITOR standards. For more information on the FNCal subprogram, refer to the description in Example 4-1 on page 46.
Lines 770 to 790	Calculates the calibration coefficients and turns on the calibration function.
Line 840	Passes control to a subprogram named Set_fixture, which configures the test fixture. For more information on the Set_fixture subprogram, refer to the description in Example 4-2 on page 60.
Line 860	Configures the 4287A to use its built-in definition for the compensation kit value.
Lines 890 to 940	Passes control to a subprogram named FNCompen, which measures the OPEN and SHORT data. For more information on the FNCompen subprogram, refer to the description in Example 4-2 on page 60.
Lines 960 to 980	Calculates the compensation coefficients and turns on the compensation function.
Lines 1020 to 1030	Sets the trigger source to GPIB/LAN trigger and turns on the continuous activation of the trigger system.
Lines 1080 to 1090	Prompts the user to connect a DUT and waits for a press of the [Enter] key after the connection.
Lines 1130 to 1180	Triggers the instrument after the trigger system is put into Waiting for Trigger state, and then retrieves the measurement results.
Lines 1220 to 1290	Displays the measurement results.
Lines 1310 to 1320	Prompts the user to choose whether to perform a measurement again. If the user presses the [y] key and [Enter] key, the program returns to the DUT connection part to repeat measurement.

Sample Application Programs
Measuring the DUT with a Test Fixture

Example 14-1

Measuring the DUT with a Test Fixture (meas_fxt.bas)

```

10 DIM Unit$(9),Para$(1:4)(9),Buff$(9),Inp_char$(9),Img$(200)
20 REAL Freq(1:32),Pow(1:32),Res(1:32,1:7),Open_l_lim,Open_u_lim
30 REAL Short_l_lim,Short_u_lim,Load_l_lim,Load_u_lim
40 INTEGER Scode,Act_tab,Nop,Ave(1:32),Result,I
50 CLEAR SCREEN
60 !
70 ASSIGN @Agt4287a TO 717
80 Scode=7
90 !
100 ! Measurement Condition
110 !
120 Act_tab=1 ! Active Table Number: 1
130 Unit$="A" ! Power Level unit: mA
140 Nop=4 ! Number of Points: 4
150 Freq(1)=1.0E+8 ! Point No.1 Frequency: 100 MHz
160 Ave(1)=1 ! Averaging Factor: 1
170 Pow(1)=.2 ! OSC Level: 0.2 mA
180 Freq(2)=8.0E+8 ! Point No.2 Frequency: 800 MHz
190 Ave(2)=1 ! Averaging Factor: 1
200 Pow(2)=.2 ! OSC Level: 0.2 mA
210 Freq(3)=1.0E+9 ! Point No.3 Frequency: 1 GHz
220 Ave(3)=1 ! Averaging Factor: 1
230 Pow(3)=.2 ! OSC Level: 0.2 mA
240 Freq(4)=3.0E+9 ! Point No.4 Frequency: 3 GHz
250 Ave(4)=1 ! Averaging Factor: 1
260 Pow(4)=.2 ! OSC Level: 0.2 mA
270 Para$(1)="LS" ! Measurement Para.1: Ls
280 Para$(2)="Q" ! Parameter Para.2: Q
290 Para$(3)="Z" ! Para.3: Z
300 Para$(4)="RS" ! Para.4: Rs
310 !
320 ! Rdc Limit for Calibration/Compensation
330 !
340 Open_l_lim=100 ! Open Rdc Lower Limit : 100 ohm
350 Open_u_lim=1.E+9 ! Open Rdc Lower Limit : Dummy
360 Short_l_lim=-1.E+9 ! Short Rdc Lower Limit: Dummy
370 Short_u_lim=25 ! Short Rdc Lower Limit: 25 ohm
380 Load_l_lim=25 ! Load Rdc Lower Limit : 25 ohm
390 Load_u_lim=100 ! Load Rdc Lower Limit : 100 ohm
400 !
410 REDIM Res(1:Nop,1:7)
420 !-----
430 ! Measurement Condition Setting
440 !-----
450 OUTPUT @Agt4287a;" :SYST:PRES"
460 OUTPUT @Agt4287a;" :FORM ASC"
470 OUTPUT @Agt4287a;" :SOUR:LIST:TABL ";Act_tab
480 OUTPUT @Agt4287a;" :SOUR:UNIT "&Unit$
490 OUTPUT @Agt4287a;" :SOUR:LIST ";Nop;" ;
500 FOR I=1 TO Nop-1
510 OUTPUT @Agt4287a;Freq(I);" ;";Ave(I);" ;";Pow(I);" ;";
520 NEXT I
530 OUTPUT @Agt4287a;Freq(Nop);" ;";Ave(Nop);" ;";Pow(Nop)
540 OUTPUT @Agt4287a;" :SOUR:LIST:STAT ON"
550 !
560 FOR I=1 TO 4
570 OUTPUT @Agt4287a;" :CALC:PAR"&VAL$(I)&" :FORM "&Para$(I)
580 NEXT I
590 !-----
600 ! Calibration
610 !-----

```

Sample Application Programs

Measuring the DUT with a Test Fixture

```
1250 PRINT USING "3A,8X,3A,8X,3A,8X,3A,#";Para$(1),Para$(2),Para$(3),
Para$(4)
1260 PRINT "          Imon          Vmon"
1270 FOR I=1 TO Nop
1280 PRINT USING Img$;I,Res(I,1),Res(I,2),Res(I,3),Res(I,4),Res(I,5)
,Res(I,6),Res(I,7)
1290 NEXT I
1300 !
1310 INPUT "Once more? [Y]es/[N]o",Inp_char$
1320 IF UPC$(Inp_char$)="Y" OR UPC$(Inp_char$)="YES" THEN Meas_start
1330 !
1340 Prog_end:END
1350 !=====
1360 ! Calibration Data Measurement Function
1370 !=====
1380 DEF FNCal(@Agt4287a,INTEGER Scode,Standard$,REAL L_lim,REAL U_lim)
1390 DIM Inp_char$(9),Trig_sour$(9),Buff$(9)
1400 REAL Meas_data
1410 INTEGER Err_flag
1420 OUTPUT @Agt4287a;":TRIG:SOUR?"
1430 ENTER @Agt4287a;Trig_sour$
1440 OUTPUT @Agt4287a;":ABOR"
1450 OUTPUT @Agt4287a;":TRIG:SOUR BUS"
1460 OUTPUT @Agt4287a;":INIT:CONT ON"
1470 OUTPUT @Agt4287a;":STAT:OPER:PTR 0"
1480 OUTPUT @Agt4287a;":STAT:OPER:NTR 16"
1490 OUTPUT @Agt4287a;":STAT:OPER:ENAB 16"
1500 OUTPUT @Agt4287a;":*SRE 128"
1510 Cal_meas:!
1520 PRINT "Set "&Standard$&"-Connection."
1530 INPUT "OK? [Y/N]",Inp_char$
1540 IF UPC$(Inp_char$)="Y" THEN
1550 OUTPUT @Agt4287a;":*CLS"
1560 OUTPUT @Agt4287a;":*OPC?"
1570 ENTER @Agt4287a;Buff$
1580 ON INTR Scode GOTO Meas_end
1590 ENABLE INTR Scode;2
1600 SELECT Standard$
1610 CASE "Open"
1620 OUTPUT @Agt4287a;":CORR1:COLL STAN1"
1630 CASE "Short"
1640 OUTPUT @Agt4287a;":CORR1:COLL STAN2"
1650 CASE "Load"
1660 OUTPUT @Agt4287a;":CORR1:COLL STAN3"
1670 CASE "Low Loss C"
1680 OUTPUT @Agt4287a;":CORR1:COLL STAN4"
1690 END SELECT
1700 OUTPUT @Agt4287a;":TRIG"
1710 PRINT "Now measuring..."
1720 Meas_wait: GOTO Meas_wait
1730 Meas_end: OFF INTR Scode
1740 Err_flag=0
1750 SELECT Standard$
1760 CASE "Open"
1770 OUTPUT @Agt4287a;":DATA:RCAD1?"
1780 ENTER @Agt4287a;Rdc
1790 PRINT "Rdc =";ABS(Rdc)
1800 IF ABS(Rdc)<L_lim THEN Err_flag=1
1810 CASE "Short"
1820 OUTPUT @Agt4287a;":DATA:RCAD2?"
1830 ENTER @Agt4287a;Rdc
1840 PRINT "Rdc =";ABS(Rdc)
1850 IF ABS(Rdc)>U_lim THEN Err_flag=1
1860 CASE "Load"
```

```

1870         OUTPUT @Agt4287a;":DATA:RCAD3?"
1880         ENTER @Agt4287a;Rdc
1890         PRINT "Rdc =";ABS(Rdc)
1900         IF ABS(Rdc)<L_lim OR ABS(Rdc)>U_lim THEN Err_flag=1
1910     END SELECT
1920     IF Err_flag=0 THEN
1930         PRINT Standard$&" Data Measurement Complete"
1940     ELSE
1950         PRINT "ERROR!!"
1960         GOTO Cal_meas
1970     END IF
1980     OUTPUT @Agt4287a;":TRIG:SOUR "&Trig_sour$
1990     RETURN 0
2000 ELSE
2010     OUTPUT @Agt4287a;":TRIG:SOUR "&Trig_sour$
2020     PRINT "Program Interruption"
2030     RETURN -1
2040 END IF
2050 FNEND
2060 !=====
2070 ! Compensation Data Measurement Function
2080 !=====
2090 DEF FNCompen(@Agt4287a,INTEGER Scode,Standard$,REAL Limit)
2100     DIM Inp_char$[9],Trig_sour$[9],Buff$[9]
2110     REAL Rdc
2120     INTEGER Err_flag
2130     OUTPUT @Agt4287a;":TRIG:SOUR?"
2140     ENTER @Agt4287a;Trig_sour$
2150     OUTPUT @Agt4287a;":ABOR"
2160     OUTPUT @Agt4287a;":TRIG:SOUR BUS"
2170     OUTPUT @Agt4287a;":INIT:CONT ON"
2180     OUTPUT @Agt4287a;":STAT:OPER:PTR 0"
2190     OUTPUT @Agt4287a;":STAT:OPER:NTR 16"
2200     OUTPUT @Agt4287a;":STAT:OPER:ENAB 16"
2210     OUTPUT @Agt4287a;":*SRE 128"
2220     Compen_meas: !
2230     PRINT "Set "&Standard$&"-Connection."
2240     INPUT "OK? [Y/N]",Inp_char$
2250     IF UPC$(Inp_char$)="Y" THEN
2260         OUTPUT @Agt4287a;":*CLS"
2270         OUTPUT @Agt4287a;":*OPC?"
2280         ENTER @Agt4287a;Buff$
2290         ON INTR Scode GOTO Meas_end
2300         ENABLE INTR Scode;2
2310         SELECT Standard$
2320             CASE "Open"
2330                 OUTPUT @Agt4287a;":CORR2:COLL STAN1"
2340             CASE "Short"
2350                 OUTPUT @Agt4287a;":CORR2:COLL STAN2"
2360         END SELECT
2370         OUTPUT @Agt4287a;":TRIG"
2380         PRINT "Now measuring..."
2390     Meas_wait: GOTO Meas_wait
2400     Meas_end: OFF INTR Scode
2410         Err_flag=0
2420         SELECT Standard$
2430             CASE "Open"
2440                 OUTPUT @Agt4287a;":DATA:RCMD1?"
2450                 ENTER @Agt4287a;Rdc
2460                 PRINT "Rdc =";ABS(Rdc)
2470                 IF ABS(Rdc)<Limit THEN Err_flag=1
2480             CASE "Short"
2490                 OUTPUT @Agt4287a;":DATA:RCMD2?"
2500                 ENTER @Agt4287a;Rdc

```

Sample Application Programs

Measuring the DUT with a Test Fixture

```
2510         PRINT "Rdc =";ABS(Rdc)
2520         IF ABS(Rdc)>Limit THEN Err_flag=1
2530     END SELECT
2540     IF Err_flag=0 THEN
2550         PRINT Standard$&" Data Measurement Complete"
2560     ELSE
2570         PRINT "ERROR!!"
2580         GOTO Compen_meas
2590     END IF
2600     OUTPUT @Agt4287a;":TRIG:SOUR "&Trig_sour$
2610     RETURN 0
2620 ELSE
2630     OUTPUT @Agt4287a;":TRIG:SOUR "&Trig_sour$
2640     PRINT "Program Interruption"
2650     RETURN -1
2660 END IF
2670 FNEND
2680 !=====
2690 ! Test Fixture Setting Function
2700 !=====
2710 SUB Set_fixture(@Agt4287a)
2720     DIM Inp_char$(30)
2730     INTEGER Fixture
2740     REAL E_len
2750     !
2760     ON ERROR GOTO Fixture_select
2770 Fixture_select: !
2780     PRINT "Select Test Fixture"
2790     PRINT " 1: None"
2800     PRINT " 2: 16191A"
2810     PRINT " 3: 16192A"
2820     PRINT " 4: 16193A"
2830     PRINT " 5: 16194A"
2840     PRINT " 6: 16196A"
2850     PRINT " 7: 16196B"
2860     PRINT " 8: 16196C"
2870     PRINT " 9: USER"
2880     INPUT "Input 1 to 9",Inp_char$
2890     Fixture=IVAL(Inp_char$,10)
2900     IF Fixture<1 OR Fixture>8 THEN Fixture_select
2910     OFF ERROR
2920     SELECT Fixture
2930         CASE 1
2940             OUTPUT @Agt4287a;":CORR2:FIXT NONE"
2950         CASE 2
2960             OUTPUT @Agt4287a;":CORR2:FIXT FXT16191A"
2970         CASE 3
2980             OUTPUT @Agt4287a;":CORR2:FIXT FXT16192A"
2990         CASE 4
3000             OUTPUT @Agt4287a;":CORR2:FIXT FXT16193A"
3010         CASE 5
3020             OUTPUT @Agt4287a;":CORR2:FIXT FXT16194A"
3030         CASE 6
3040             OUTPUT @Agt4287a;":CORR2:FIXT FXT16196A"
3050         CASE 7
3060             OUTPUT @Agt4287a;":CORR2:FIXT FXT16196B"
3070         CASE 8
3080             OUTPUT @Agt4287a;":CORR2:FIXT FXT16196C"
3090         CASE 9
3100             OUTPUT @Agt4287a;":CORR2:FIXT USER"
3110             CALL Inp_data("Electrical Length of the User Fixture",E_len)
3120             OUTPUT @Agt4287a;":CORR2:FIXT:EDEL:DIST ";E_len
3130     END SELECT
3140 SUBEND
```

```
3150  !=====
3160  ! Data Input Function
3170  !=====
3180  SUB Inp_data(Mes$,Inp_val)
3190    DIM Inp_char$(30)
3200    ON ERROR GOTO Inp_start
3210  Inp_start:
3220    PRINT "Input "&Mes$
3230    INPUT "Value?",Inp_char$
3240    Inp_val=VAL(UPC$(Inp_char$))
3250    PRINT "Input Value: ";Inp_val
3260    INPUT "OK? [Y/N]",Inp_char$
3270    IF UPC$(Inp_char$)<>"Y" THEN Inp_start
3280    OFF ERROR
3290  SUBEND
```

Using an Auto-sorting System

Example 14-2 shows a sample program designed for use with a handler-based auto-sorting system to automate the measurement task on a 10 nH inductor. You can find the source file of this program, named `meas_sys.bas`, on the sample program disk.

Start the program after setting up the auto-sorting system. The program prompts you to enter the definition values for the LOAD standard. Following the on-screen instructions, you must enter the R_s , L_s , and R_{dc} values for the LOAD standards (predefined working standards) at 100 MHz and 800 MHz.

When you have finished defining the LOAD standard values, the program displays the message “Set Open-Connection.” Disconnect the system’s test connectors (such as the contact probe) so that the test circuit is open and press the **[y]** key followed by the **[Enter]** key to measure the OPEN data for calculating the calibration coefficients. When you are presented with the message “Set Short-Connection,” short-circuit the test connectors, and press the **[y]** key followed by the **[Enter]** key to obtain the SHORT measurement data for calculating the calibration coefficients. Finally, the program displays the message “Set Load-Connection.” Connect the working standard to the test connectors and press the **[y]** key followed by the **[Enter]** key to measure the LOAD data for calculating the calibration coefficients.

When the instrument has finished the above measurement, the program turns on the calibration function and displays the message “Set Dut. Then input external trigger.” In the auto-sorting system, connect the test connectors with a DUT and input an external trigger signal from the handler interface. When the instrument has finished measuring the DUT, the program displays the result of bin sorting. The program repeats this process 10 times.

When the instrument has finished the 10th cycle of measurement, the program displays the statistics including the number of DUTs sorted into each bin, saves the measurement results under the file name `log_data.csv`, and then terminates.

The program is described in detail below:

Lines 110 to 120	Sets the GPIB address and select code.
Lines 160 to 180	Stores the active table number (No.1), the unit of the signal source level (mV), and the number of measurement points (2 points) into the <code>Act_tab</code> , <code>Unit\$</code> , and <code>Nop</code> variables, respectively.
Lines 190 to 240	Stores the frequency, averaging factor, and signal source level at each point into the <code>Freq(*)</code> , <code>Ave(*)</code> , and <code>Pow(*)</code> arrays, respectively. The <code>Freq(*)</code> array contains two values of 100 MHz and 800 MHz; the <code>Ave(*)</code> array contains “1” for all points; the <code>Pow(*)</code> array contains “500 mV” for all points.
Lines 250 to 270	Stores the on/off settings for the screen display (on), beep (off), and key lock (on) into the <code>Disp\$</code> , <code>Beep\$</code> , and <code>Lock\$</code> variables, respectively.
Line 280	Stores the name of the measurement result file (<code>log_data.csv</code>) into the <code>File\$</code> variable.
Line 290	Stores the number of measurement cycles (10) into the <code>Meas_max</code> variable.
Lines 330 to 380	Stores the R_{dc} measurement lower limit for the OPEN standard (100 Ω) into the <code>Open_l_lim</code> variable and the R_{dc} measurement upper limit

for the SHORT standard (25 Ω) into the Short_u_lim variable.

NOTE

The sample program sets the R_{dc} limits for each standard by assuming only typical uses: a lower limit of 100 Ω for the OPEN standard, an upper limit of 25 Ω for the SHORT standard, and no limits for the LOAD standard. To gain more effective protection against operational errors, however, it is recommended that you modify these values based on your actual working standards; for more information, refer to *Preventing operational errors when measuring data for calculating calibration coefficients* on page 40.

- Lines 420 to 430 Stores the lower and upper limits (-10 Ω and 10 Ω) for the R_{dc} measurement for conduct check into the Rdc_l_lim and Rdc_u_lim variables, respectively.
- Lines 470 to 480 Stores the maximum sorting condition number (4) into the Max_cond variable and the maximum bin number (6) into the Max_bin variable.
- Line 490 Stores the maximum good bin number (2) into the Ogbin variable.
- Lines 500 to 1420 Stores sorting condition settings into the corresponding variables to configure the sorting conditions for each bin as follows:

	100 MHz		800 MHz	
	Ls (reference value: 10 nH)	Q	Ls (reference value: 10 nH)	Q
BIN1 (good bin)	Within the range of ± 3%	≥ 10	Within the range of ± 5%	≥ 10
BIN2 (good bin)	Within the range of ± 5%	≥ 10	Within the range of ± 5%	≥ 10
BIN3 (bad bin)	Within the range of ± 5%	≥ 10	Within the range of ± 5%	< 10
BIN4 (bad bin)	Within the range of ± 5%	≥ 10	Not within the range of ± 5% (exclusive of ±5%)	≥ 10
BIN5 (bad bin)	Within the range of ± 5%	≥ 10	Not within the range of ± 5% (exclusive of ±5%)	< 10
BIN6 (bad bin)	Within the range of ± 5%	< 10	No condition	No condition

- Lines 1460 to 1470 Resets the instrument and sets the data transfer format to ASCII.
- Lines 1480 to 1490 Sets the active table number to Act_tab and the unit of the signal source level to Unit\$.
- Lines 1500 to 1540 Configures the measurement point setup table.
- Line 1550 Turns on list measurement.
- Lines 1560 to 1570 Turns on R_{dc} measurement and sets the limit range for R_{dc} measurement to the range between Rdc_l_lim and Rdc_u_lim.
- Lines 1580 to 1610 Assigns the bin sorting parameters (Para\$(1) and Para\$(2)) to measurement parameters 1 and 2 and hides the results for measurement parameters 3 and 4.
- Line 1620 to 1640 Turns off the screen display and beep.
- Line 1650 to 1670 Locks the front panel, keyboard, and mouse.

Sample Application Programs

Using an Auto-sorting System

- Line 1710 to 1730 Configures the instrument to use the user-defined calibration kit with its values (Rs-Ls) defined for each measurement point.
- Lines 1740 to 1820 Passes control to a subprogram named Inp_data, which obtains the definition values for the load (working standard) from user input. For more information on the Inp_data subprogram, refer to the description in Example 4-1 on page 46.
- Lines 1840 to 1920 Passes control to a subprogram named FNCal, which measures the data for OPEN, SHORT, and LOAD standards. For more information on the FNCal subprogram, refer to the description in Example 4-1 on page 46.
- Lines 1940 to 1960 Calculates the calibration coefficients and turns on the calibration function.
- Lines 2000 to 2020 After measurement is stopped (the trigger system is stopped), the program sets the trigger source to External trigger and turns on the continuous activation of the trigger system.
- Lines 2060 to 2200 Configures the bin sorting setup table.
- Lines 2210 to 2220 Assigns all bins with numbers greater than Ogbin as good bins and turn on the bin sorting function.
- Lines 2230 to 2260 Turns on the bin count function and clears the current bin count.
- Lines 2300 to 2320 Calculates and sets the maximum number of data segments captured for statistical analysis and then begins retrieving the data.
- Lines 2370 to 2400 Configures the instrument to generate an SRQ upon completion of measurement.
- Lines 2420 to 2580 Iterates the following steps Meas_max times.
1. Lines 2340 to 2460: Waits until the trigger system is put into Waiting for Trigger state.
 2. Lines 2470 to 2490: Clears the status byte register and operation status event register.
 3. Lines 2500 to 2510: Sets the branch target for an SRQ interrupt to enable SRQ interrupts.
 4. Lines 2520 to 2530: Prompts the user to connect a DUT and input an external trigger. The program waits until the instrument receives an external trigger and completes the measurement cycle.

NOTE

As shown in this example, the measurement cycle must be synchronized with the operation status of the 4287A (trigger input timing, detection of the end of measurement, and so on). The sample program uses the status report system to provide synchronization with the trigger input and end of measurement. In a handler-based auto-sorting system, you can also use handler interface output signals such as /READY_FOR_TRIG, /INDEX, or /EOM to achieve synchronization.

5. Lines 2550 to 2570: Retrieves and displays the results of bin sorting.

NOTE

In a handler-based auto-sorting system, you can also use handler interface signals such as

/BIN1 through /BIN13 or /OUT_OF_GOOD_BINS to obtain the results of bin sorting.

Lines 2620 to 2720 Retrieves and displays the bin count.

Lines 2730 to 2990 Performs statistical analysis and then retrieves and displays the results.

Lines 3030 to 3040 Saves the measurement results (data stored in the volatile memory for statistical analysis) under the file name identified by the File\$ variable.

Example 14-2

Using an Auto-Sorting System (meas_sys.bas)

```

10     DIM Unit$(9),Para$(1:4)(9),Lim_mode$(1:4)(9),L_type$(1:13,1:4)(9]
20     DIM File$(20),Disp$(9),Beep$(9),Lock$(9),Img1$(200),Img2$(200],
Buff$(9]
30     REAL Freq(1:32),Pow(1:32),Point_no(1:4),L_lim(1:13,1:4),U_lim
(1:13,1:4)
40     REAL Nominal(1:13),R1(1:32,1:10),R2(1:32,1:10)
50     REAL Load_rs,Load_ls,Load_rdc,Rdc_l_lim,Rdc_u_lim
60     REAL Open_l_lim,Open_u_lim,Short_l_lim,Short_u_lim,Load_l_lim,
Load_u_lim
70     INTEGER Scode,Act_tab,Nop,Ave(1:32),Meas_max,Result,Cond_reg,I,J
80     INTEGER Max_cond,Max_bin,Ogbin,Bin_sort_result,Bin(1:14)
90     CLEAR SCREEN
100    !
110    ASSIGN @Agt4287a TO 717
120    Scode=7
130    !
140    ! Measurement Condition
150    !
160    Act_tab=1           ! Active Table Number: 1
170    Unit$="V"          ! Power Level unit: mV
180    Nop=2              ! Number of Points: 2
190    Freq(1)=1.0E+8     ! Point No.1  Frequency: 100 MHz
200    Ave(1)=1           !           Averaging Factor: 1
210    Pow(1)=500         !           OSC Level: 500 mV
220    Freq(2)=8.0E+8    ! Point No.2  Frequency: 800 MHz
230    Ave(2)=1           !           Averaging Factor: 1
240    Pow(2)=500         !           OSC Level: 500 mV
250    Disp$="OFF"       ! Display Off
260    Beep$="OFF"        ! Done/Warn Beeper Off
270    Lock$="ON"         ! Front panel/KBD/Mouse Lock On
280    File$="log_data.csv" ! Log Data Save File Name
290    Meas_max=10        ! Maximum Measurement Number
300    !
310    ! Rdc Limit for Calibration/Compensation
320    !
330    Open_l_lim=100     ! Open Rdc Lower Limit : 100 ohm
340    Open_u_lim=1.E+9   ! Open Rdc Upper Limit : Dummy
350    Short_l_lim=-1.E+9 ! Short Rdc Lower Limit: Dummy
360    Short_u_lim=25     ! Short Rdc Upper Limit: 25 ohm
370    Load_l_lim=-1.E+9 ! Load Rdc Lower Limit : Dummy
380    Load_u_lim=1.E+9  ! Load Rdc Upper Limit : Dummy
390    !
400    ! Rdc Limit for Contact Check
410    !
420    Rdc_l_lim=-10     ! Lower Limit : -10 ohm
430    Rdc_u_lim=10      ! Upper Limit : 10 ohm
440    !
450    ! Bin Sort
460    !
470    Max_cond=4
480    Max_bin=6

```

Sample Application Programs
Using an Auto-sorting System

```

490  Ogbin=2
500  !
510  Point_no(1)=1      ! Condition 1 Point No. : 1 (100 MHz)
520  Para$(1)="LS"     !           Parameter : Ls
530  Lim_mode$(1)="PCNT" !           Limit mode: Percent
540  Nominal(1)=1.0E-8 !           Nominal   : 10 nF
550  Point_no(2)=1     ! Condition 2 Point No. : 1 (100 MHz)
560  Para$(2)="Q"      !           Parameter : Q
570  Lim_mode$(2)="ABS" !           Limit mode: Absolute
580  Point_no(3)=2     ! Condition 3 Point No. : 2 (800 MHz)
590  Para$(3)="LS"     !           Parameter : Ls
600  Lim_mode$(3)="PCNT" !           Limit mode: Percent
610  Nominal(3)=1.0E-8 !           Nominal   : 10 nF
620  Point_no(4)=2     ! Condition 4 Point No. : 1 (100 MHz)
630  Para$(4)="Q"      !           Parameter : Q
640  Lim_mode$(4)="ABS" !           Limit mode: Absolute
650  !
660  L_lim(1,1)=-3.0   ! Condition 1 Lower Limit : -3 %
670  U_lim(1,1)=3.0   !           Upper Limit : +3 %
680  L_type$(1,1)="IN" !           Limit Type  : IN
690  L_lim(1,2)=10.0  ! Condition 2 Lower Limit : 10
700  U_lim(1,2)=1.0E+9 !           Upper Limit : 1E9
710  L_type$(1,2)="IN" !           Limit Type  : IN
720  L_lim(1,3)=-5.0  ! Condition 3 Lower Limit : -5 %
730  U_lim(1,3)=5.0   !           Upper Limit : +5 %
740  L_type$(1,3)="IN" !           Limit Type  : IN
750  L_lim(1,4)=10.0  ! Condition 4 Lower Limit : 10
760  U_lim(1,4)=1.0E+9 !           Upper Limit : 1E9
770  L_type$(1,4)="IN" !           Limit Type  : IN
780  !
790  L_lim(2,1)=-5.0   ! Condition 1 Lower Limit : -5 %
800  U_lim(2,1)=5.0   !           Upper Limit : +5 %
810  L_type$(2,1)="IN" !           Limit Type  : IN
820  L_lim(2,2)=10.0  ! Condition 2 Lower Limit : 10
830  U_lim(2,2)=1.0E+9 !           Upper Limit : 1E9
840  L_type$(2,2)="IN" !           Limit Type  : IN
850  L_lim(2,3)=-5.0  ! Condition 3 Lower Limit : -5 %
860  U_lim(2,3)=5.0   !           Upper Limit : +5 %
870  L_type$(2,3)="IN" !           Limit Type  : IN
880  L_lim(2,4)=10.0  ! Condition 4 Lower Limit : 10
890  U_lim(2,4)=1.0E+9 !           Upper Limit : 1E9
900  L_type$(2,4)="IN" !           Limit Type  : IN
910  !
920  L_lim(3,1)=-5.0   ! Condition 1 Lower Limit : -5 %
930  U_lim(3,1)=5.0   !           Upper Limit : +5 %
940  L_type$(3,1)="IN" !           Limit Type  : IN
950  L_lim(3,2)=10.0  ! Condition 2 Lower Limit : 10
960  U_lim(3,2)=1.0E+9 !           Upper Limit : 1E9
970  L_type$(3,2)="IN" !           Limit Type  : IN
980  L_lim(3,3)=-5.0  ! Condition 3 Lower Limit : -5 %
990  U_lim(3,3)=5.0   !           Upper Limit : +5 %
1000 L_type$(3,3)="IN" !           Limit Type  : IN
1010 L_lim(3,4)=10.0  ! Condition 4 Lower Limit : 10
1020 U_lim(3,4)=1.0E+9 !           Upper Limit : 1E9
1030 L_type$(3,4)="OUT" !           Limit Type  : OUT
1040 !
1050 L_lim(4,1)=-5.0   ! Condition 1 Lower Limit : -5 %
1060 U_lim(4,1)=5.0   !           Upper Limit : +5 %
1070 L_type$(4,1)="IN" !           Limit Type  : IN
1080 L_lim(4,2)=10.0  ! Condition 2 Lower Limit : 10
1090 U_lim(4,2)=1.0E+9 !           Upper Limit : 1E9
1100 L_type$(4,2)="IN" !           Limit Type  : IN
1110 L_lim(4,3)=-5.0  ! Condition 3 Lower Limit : -5 %
1120 U_lim(4,3)=5.0   !           Upper Limit : +5 %

```

```

1130 L_type$(4,3)="OUT"      !           Limit Type : OUT
1140 L_lim(4,4)=10.0        ! Condition 4 Lower Limit : 10
1150 U_lim(4,4)=1.0E+9     !           Upper Limit : 1E9
1160 L_type$(4,4)="IN"     !           Limit Type : IN
1170 !                      =====[BIN5]=====
1180 L_lim(5,1)=-5.0       ! Condition 1 Lower Limit : -5 %
1190 U_lim(5,1)=5.0       !           Upper Limit : +5 %
1200 L_type$(5,1)="IN"    !           Limit Type : IN
1210 L_lim(5,2)=10.0      ! Condition 2 Lower Limit : 10
1220 U_lim(5,2)=1.0E+9   !           Upper Limit : 1E9
1230 L_type$(5,2)="IN"    !           Limit Type : IN
1240 L_lim(5,3)=-5.0     ! Condition 3 Lower Limit : -5 %
1250 U_lim(5,3)=5.0     !           Upper Limit : +5 %
1260 L_type$(5,3)="OUT"   !           Limit Type : OUT
1270 L_lim(5,4)=10.0     ! Condition 4 Lower Limit : 10
1280 U_lim(5,4)=1.0E+9   !           Upper Limit : 1E9
1290 L_type$(5,4)="OUT"   !           Limit Type : OUT
1300 !                      =====[BIN6]=====
1310 L_lim(6,1)=-5.0     ! Condition 1 Lower Limit : -5 %
1320 U_lim(6,1)=5.0     !           Upper Limit : +5 %
1330 L_type$(6,1)="IN"    !           Limit Type : IN
1340 L_lim(6,2)=10.0     ! Condition 2 Lower Limit : 10
1350 U_lim(6,2)=1.0E+9   !           Upper Limit : 1E9
1360 L_type$(6,2)="OUT"   !           Limit Type : OUT
1370 L_lim(6,3)=-5.0     ! Condition 3 Lower Limit : -5 % (Dummy)
1380 U_lim(6,3)=5.0     !           Upper Limit : +5 % (Dummy)
1390 L_type$(6,3)="ALL"   !           Limit Type : ALL
1400 L_lim(6,4)=10.0     ! Condition 4 Lower Limit : 10 (Dummy)
1410 U_lim(6,4)=1.0E+9   !           Upper Limit : 1E9 (Dummy)
1420 L_type$(6,4)="ALL"   !           Limit Type : ALL
1430 !-----
1440 ! Measurement Condition Setting
1450 !-----
1460 OUTPUT @Agt4287a;" :SYST:PRES"
1470 OUTPUT @Agt4287a;" :FORM ASC"
1480 OUTPUT @Agt4287a;" :SOUR:LIST:TABL ";Act_tab
1490 OUTPUT @Agt4287a;" :SOUR:UNIT "&Unit$
1500 OUTPUT @Agt4287a;" :SOUR:LIST ";Nop;" ;
1510 FOR I=1 TO Nop-1
1520   OUTPUT @Agt4287a;Freq(I);" ;";Ave(I);" ;";Pow(I);" ;";
1530 NEXT I
1540 OUTPUT @Agt4287a;Freq(Nop);" ;";Ave(Nop);" ;";Pow(Nop)
1550 OUTPUT @Agt4287a;" :SOUR:LIST:STAT ON"
1560 OUTPUT @Agt4287a;" :SOUR:LIST:RDC ON"
1570 OUTPUT @Agt4287a;" :CALC:COMP:RDC:LIM ";Rdc_l_lim;" ;";Rdc_u_lim
1580 OUTPUT @Agt4287a;" :CALC:PAR1:FORM "&Para$(1)
1590 OUTPUT @Agt4287a;" :CALC:PAR2:FORM "&Para$(2)
1600 OUTPUT @Agt4287a;" :DISP:TEXT1:CALC3 OFF"
1610 OUTPUT @Agt4287a;" :DISP:TEXT1:CALC4 OFF"
1620 OUTPUT @Agt4287a;" :DISP "&Disp$
1630 OUTPUT @Agt4287a;" :SYST:BEEP1:STAT "&Beep$
1640 OUTPUT @Agt4287a;" :SYST:BEEP2:STAT "&Beep$
1650 OUTPUT @Agt4287a;" :SYST:KLOC "&Lock$
1660 OUTPUT @Agt4287a;" :SYST:KLOC:KBD "&Lock$
1670 OUTPUT @Agt4287a;" :SYST:KLOC:MOUS "&Lock$
1680 !-----
1690 ! Calibration
1700 !-----
1710 OUTPUT @Agt4287a;" :CORR1:CKIT USER"
1720 OUTPUT @Agt4287a;" :CORR1:CKIT:LIST ON"
1730 OUTPUT @Agt4287a;" :CORR1:CKIT:STAN3:FORM RL"
1740 FOR I=1 TO Nop
1750   PRINT "## For Point No.:";I;"   Frequency:";Freq(I);" ##"
1760   CALL Inp_data("Load Rs Value",Load_rs)

```

Sample Application Programs Using an Auto-sorting System

```
1770     CALL Inp_data("Load Ls Value",Load_ls)
1780     OUTPUT @Agt4287a;":CORR1:CKIT:STAN3:LIST ";I;",";Load_rs;",";
Load_ls
1790     NEXT I
1800     PRINT "## For Rdc ##"
1810     CALL Inp_data("Load Rdc Value",Load_rdc)
1820     OUTPUT @Agt4287a;":CORR1:CKIT:STAN3:DC ";Load_rdc
1830     !
1840     PRINT "## Measurement for Calibration##"
1850     Result=FNCal(@Agt4287a,Scode,"Open",Open_l_lim,Open_u_lim)
1860     IF Result<>0 THEN Prog_end
1870     !
1880     Result=FNCal(@Agt4287a,Scode,"Short",Short_l_lim,Short_u_lim)
1890     IF Result<>0 THEN Prog_end
1900     !
1910     Result=FNCal(@Agt4287a,Scode,"Load",Load_l_lim,Load_u_lim)
1920     IF Result<>0 THEN Prog_end
1930     !
1940     OUTPUT @Agt4287a;":CORR1:COLL:SAVE"
1950     OUTPUT @Agt4287a;":*OPC?"
1960     ENTER @Agt4287a;Buff$
1970     !-----
1980     ! Trigger source setting
1990     !-----
2000     OUTPUT @Agt4287a;":ABOR"
2010     OUTPUT @Agt4287a;":TRIG:SOUR EXT"
2020     OUTPUT @Agt4287a;":INIT:CONT ON"
2030     !-----
2040     ! BIN sort setting
2050     !-----
2060     FOR I=1 TO Max_cond
2070         OUTPUT @Agt4287a;":CALC:COMP:COND"&VAL$(I)&":SNUM ";Point_no(I)
2080         OUTPUT @Agt4287a;":CALC:COMP:COND"&VAL$(I)&":PAR "&Para$(I)
2090         OUTPUT @Agt4287a;":CALC:COMP:COND"&VAL$(I)&":MODE "&Lim_mode$(
I)
2100         IF Lim_mode$(I)<>"ABS" THEN
2110             OUTPUT @Agt4287a;":CALC:COMP:COND"&VAL$(I)&":NOM ";Nominal(I)
2120         END IF
2130         FOR J=1 TO Max_bin
2140             OUTPUT @Agt4287a;":CALC:COMP:BIN"&VAL$(J)&" ON"
2150             OUTPUT @Agt4287a;":CALC:COMP:BIN"&VAL$(J)&":COND"&VAL$(I)&":L
TYP "&L_type$(J,I)
2160             IF L_type$(J,I)<>"ALL" THEN
2170                 OUTPUT @Agt4287a;":CALC:COMP:BIN"&VAL$(J)&":COND"&VAL$(I)&":
LIM ";L_lim(J,I);",";U_lim(J,I)
2180             END IF
2190         NEXT J
2200     NEXT I
2210     OUTPUT @Agt4287a;":CALC:COMP:OGB ";Ogbin
2220     OUTPUT @Agt4287a;":CALC:COMP ON"
2230     OUTPUT @Agt4287a;":CALC:COMP:COUN ON"
2240     OUTPUT @Agt4287a;":CALC:COMP:COUN:CLE"
2250     OUTPUT @Agt4287a;":*OPC?"
2260     ENTER @Agt4287a;Buff$
2270     !-----
2280     ! Statistical analysis setting
2290     !-----
2300     Data_size=5*Nop*Meas_max
2310     OUTPUT @Agt4287a;":CALC:EXAM:SIZE ";Data_size
2320     OUTPUT @Agt4287a;":CALC:EXAM:STAR"
2330     !-----
2340     ! Measurement
2350     !-----
2360     ! For SRQ
```

```

2370 OUTPUT @Agt4287a;":STAT:OPER:PTR 0"
2380 OUTPUT @Agt4287a;":STAT:OPER:NTR 16"
2390 OUTPUT @Agt4287a;":STAT:OPER:ENAB 16"
2400 OUTPUT @Agt4287a;"*SRE 128"
2410 ! Triggering and data read
2420 FOR I=1 TO Meas_max
2430 REPEAT
2440     OUTPUT @Agt4287a;":STAT:OPER:COND?"
2450     ENTER @Agt4287a;Cond_reg
2460     UNTIL BIT(Cond_reg,5)
2470     OUTPUT @Agt4287a;"*CLS"
2480     OUTPUT @Agt4287a;"*OPC?"
2490     ENTER @Agt4287a;Buff$
2500     ON INTR Scode GOTO Meas_end
2510     ENABLE INTR Scode;2
2520     PRINT "Set Dut. Then input external trigger."
2530 Meas_wait: GOTO Meas_wait
2540 Meas_end: OFF INTR Scode
2550     OUTPUT @Agt4287a;":CALC:COMP:DATA:BIN?"
2560     ENTER @Agt4287a;Bin_sort_result
2570     PRINT "Meas. No.:"&VAL$(I),"BIN ="&Bin_sort_result
2580 NEXT I
2590 !-----
2600 ! Display
2610 !-----
2620 ! [BIN Count Result]
2630 OUTPUT @Agt4287a;":CALC:COMP:DATA:BCOU?"
2640 ENTER @Agt4287a;Bin(*)
2650 Img1$="2X,15A,5D"
2660 PRINT "[BIN Count Result]"
2670 PRINT "    BIN                Count"
2680 PRINT " -----"
2690 FOR I=1 TO 13
2700     PRINT USING Img1$;"BIN"&VAL$(I)&":",Bin(I)
2710 NEXT I
2720 PRINT USING Img1$;"OUT OF BIN1-13:",Bin(14)
2730 ! [Statistical Analysis Result]
2740 FOR I=1 TO Nop
2750     OUTPUT @Agt4287a;":CALC:EXAM:GET? 1,"&I
2760     ENTER @Agt4287a;P1(I,1),P1(I,2),P1(I,3),P1(I,4),P1(I,5),
P1(I,6),P1(I,7),P1(I,8),P1(I,9),P1(I,10)
2770     OUTPUT @Agt4287a;":CALC:EXAM:GET? 2,"&I
2780     ENTER @Agt4287a;P2(I,1),P2(I,2),P2(I,3),P2(I,4),P2(I,5),
P2(I,6),P2(I,7),P2(I,8),P2(I,9),P2(I,10)
2790 NEXT I
2800     Img1$="X,3A,X,3D,2X,MD.4DE,X,MD.4DE,X,MD.4DE,X,MD.4DE,X,MD.4DE"
2810     Img2$="X,3A,X,3D,2X,10D,2X,10D,2X,10D,2X,10D,2X,10D"
2820     PRINT "[Statistical Analysis Result]"
2830     PRINT "          ----- Statistical Value for Normal Data -----
-----"
2840     PRINT "Para Point      Mean          Sigma      3*Sigma/Mean Min.      M
ax."
2850     FOR I=1 TO Nop
2860         PRINT USING Img1$;Para$(1),I,P1(I,1),P1(I,2),P1(I,3),P1(I,4),
P1(I,5)
2870     NEXT I
2880     FOR I=1 TO Nop
2890         PRINT USING Img1$;Para$(2),I,P2(I,1),P2(I,2),P2(I,3),P2(I,4),
P2(I,5)
2900     NEXT I
2910     PRINT ""
2920     PRINT "          ----- Occurrence Count -----
-----"
2930     PRINT "Para Point      Normal      Rdc Fail      Overload      Abnormal A

```

Sample Application Programs Using an Auto-sorting System

```
11"
2940   FOR I=1 TO Nop
2950     PRINT USING Img2$;Para$(1),I,P1(I,6),P1(I,7),P1(I,8),P1(I,9),
P1(I,10)
2960   NEXT I
2970   FOR I=1 TO Nop
2980     PRINT USING Img2$;Para$(2),I,P2(I,6),P2(I,7),P2(I,8),P2(I,9),
P2(I,10)
2990   NEXT I
3000   !-----
3010   ! Save Log Data
3020   !-----
3030   OUTPUT @Agt4287a;":MMEM:STOR ""&File$&""",LOG"
3040   PRINT "Log Data File: "&File$
3050   !
3060 Prog_end:END
3070   !=====
3080   ! Calibration Data Measurement Function
3090   !=====
3100 DEF FNCal(@Agt4287a,INTEGER Scode,Standard$,REAL L_lim,REAL U_lim)
3110 DIM Inp_char$(9),Trig_sour$(9),Buff$(9)
3120 REAL Meas_data
3130 INTEGER Err_flag
3140 OUTPUT @Agt4287a;":TRIG:SOUR?"
3150 ENTER @Agt4287a;Trig_sour$
3160 OUTPUT @Agt4287a;":ABOR"
3170 OUTPUT @Agt4287a;":TRIG:SOUR BUS"
3180 OUTPUT @Agt4287a;":INIT:CONT ON"
3190 OUTPUT @Agt4287a;":STAT:OPER:PTR 0"
3200 OUTPUT @Agt4287a;":STAT:OPER:NTR 16"
3210 OUTPUT @Agt4287a;":STAT:OPER:ENAB 16"
3220 OUTPUT @Agt4287a;":*SRE 128"
3230 Cal_meas: !
3240 PRINT "Set "&Standard$&"-Connection."
3250 INPUT "OK? [Y/N]",Inp_char$
3260 IF UPC$(Inp_char$)="Y" THEN
3270   OUTPUT @Agt4287a;":*CLS"
3280   OUTPUT @Agt4287a;":*OPC?"
3290   ENTER @Agt4287a;Buff$
3300   ON INTR Scode GOTO Meas_end
3310   ENABLE INTR Scode;2
3320   SELECT Standard$
3330     CASE "Open"
3340       OUTPUT @Agt4287a;":CORR1:COLL STAN1"
3350     CASE "Short"
3360       OUTPUT @Agt4287a;":CORR1:COLL STAN2"
3370     CASE "Load"
3380       OUTPUT @Agt4287a;":CORR1:COLL STAN3"
3390     CASE "Low Loss C"
3400       OUTPUT @Agt4287a;":CORR1:COLL STAN4"
3410   END SELECT
3420   OUTPUT @Agt4287a;":TRIG"
3430   PRINT "Now measuring..."
3440 Meas_wait: GOTO Meas_wait
3450 Meas_end: OFF INTR Scode
3460   Err_flag=0
3470   SELECT Standard$
3480     CASE "Open"
3490       OUTPUT @Agt4287a;":DATA:RCAD1?"
3500       ENTER @Agt4287a;Rdc
3510       PRINT "Rdc =" ;ABS(Rdc)
3520       IF ABS(Rdc)<L_lim THEN Err_flag=1
3530     CASE "Short"
3540       OUTPUT @Agt4287a;":DATA:RCAD2?"
```



```

3550     ENTER @Agt4287a;Rdc
3560     PRINT "Rdc =" ;ABS(Rdc)
3570     IF ABS(Rdc)>U_lim THEN Err_flag=1
3580     CASE "Load"
3590         OUTPUT @Agt4287a;" :DATA:RCAD3?"
3600         ENTER @Agt4287a;Rdc
3610         PRINT "Rdc =" ;ABS(Rdc)
3620         IF ABS(Rdc)<L_lim OR ABS(Rdc)>U_lim THEN Err_flag=1
3630     END SELECT
3640     IF Err_flag=0 THEN
3650         PRINT Standard$&" Data Measurement Complete"
3660     ELSE
3670         PRINT "ERROR!!"
3680         GOTO Cal_meas
3690     END IF
3700     OUTPUT @Agt4287a;" :TRIG:SOUR "&Trig_sour$
3710     RETURN 0
3720 ELSE
3730     OUTPUT @Agt4287a;" :TRIG:SOUR "&Trig_sour$
3740     PRINT "Program Interruption"
3750     RETURN -1
3760 END IF
3770 FNEND
3780 !=====
3790 ! Data Input Function
3800 !=====
3810 SUB Inp_data(Mes$,Inp_val)
3820     DIM Inp_char$(30)
3830     ON ERROR GOTO Inp_start
3840 Inp_start:
3850     PRINT "Input "&Mes$
3860     INPUT "Value?",Inp_char$
3870     Inp_val=VAL(UPC$(Inp_char$))
3880     PRINT "Input Value: ";Inp_val
3890     INPUT "OK? [Y/N]",Inp_char$
3900     IF UPC$(Inp_char$)<>"Y" THEN Inp_start
3910     OFF ERROR
3920 SUBEND

```

Measuring Array (Multi-Element) Components

When measuring an array component with the scanner, you must select appropriate calibration coefficients for each channel, switched by the scanner, to make a correct measurement (by eliminating errors that depend on measurement paths).

The 4287A can handle up to 8 tables for different measurement conditions (including calibration coefficients). This capability is used to set calibration coefficients for each channel. Specifically, calibration coefficients for all of the channels are first obtained in advance based on tables configured for the same measurement condition. Then, while performing measurement for each channel, the corresponding table is used. In this way, you can perform measurements under the same measurement condition but with different calibration coefficients.

The following describes how to use the 4287A to measure array components.

Step 1. Configuring the setup tables

Configure the measurement point setup tables and the calibration kit setup tables for all required channels. If you use the bin sorting function (comparator), also configure the bin sorting setup tables.

Step 2. Obtaining calibration coefficients

Change the channel and active table together and measure the OPEN/SHORT/LOAD data to calculate the calibration coefficients for each channel.

Figure 14-1 Timing Chart of Array Component Measurement (using 2 channels)

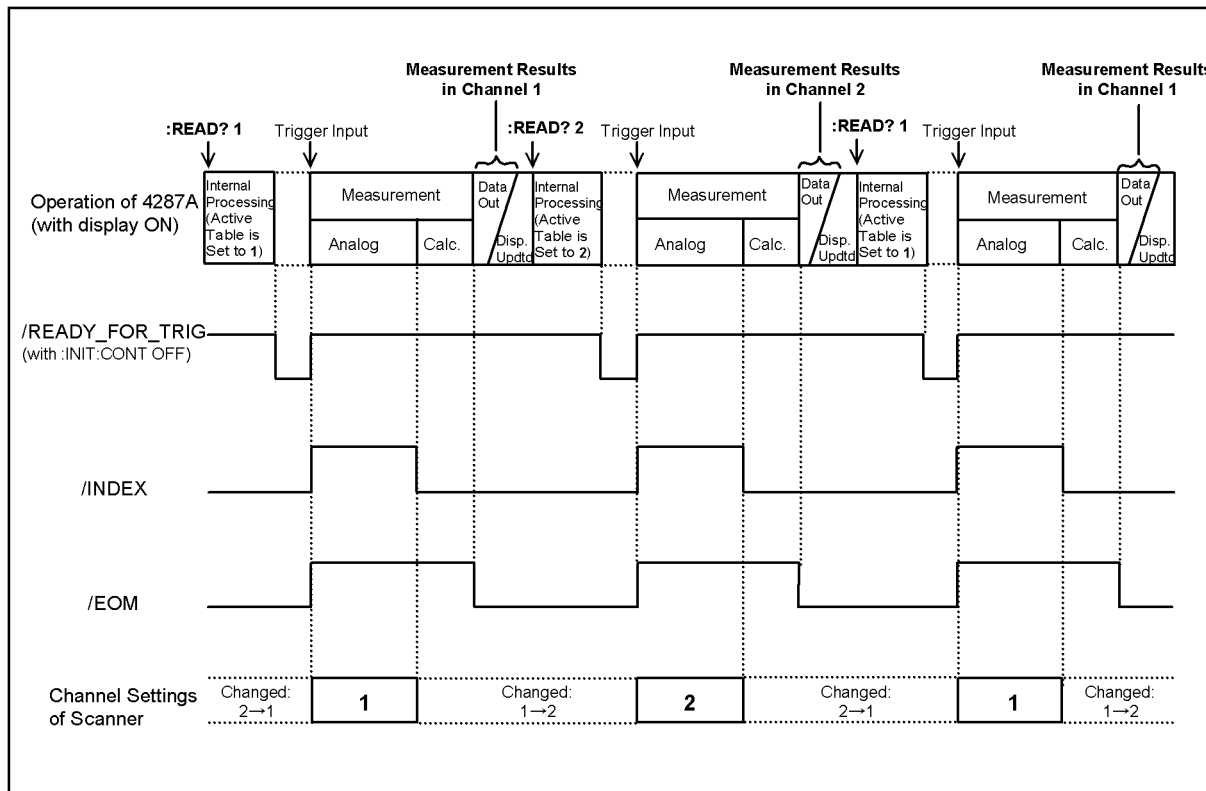

4287ape028

Step 3. Performing measurement

After setting the channels, perform measurement for each channel while changing the active table to the corresponding table with the **:READ?** command on page 287. During measurement, use the **/READY_FOR_TRIG** signal for appropriate trigger timing. For details on the timing of trigger input, refer to “Trigger Input Timing When Using the **:READ?** Command” on page 98. Figure 14-1 shows the timing chart of command execution, trigger input, and channel setup.

Step 4. Sorting and judgment

After completing measurement for all channels, based on the measurement result (or the bin sorting result) for each channel retrieved with the **:READ?** command, perform PASS/FAIL judgment of the DUT as a single array component or bin sorting judgment using an external controller.

Sample Program

Example 14-3 shows a sample program for measuring 4-inductor arrays. You can find the source file of this program, named `meas_ary.bas`, on the sample program disk.

Start the program. The program prompts you to enter the definition values for the LOAD standard. Following the on-screen instructions, you must enter the R_s , L_s , and R_{dc} values for the LOAD standards for each channel (predefined working standards).

When you have finished defining the LOAD standard values, the program displays the message “Set the Scanner's Channel to No.1, and Set Open-Connection.” Set the scanner's channel to 1, disconnect the system's test connectors for channel 1 (such as the contact probe) so that the test circuit is open, and press the **[y]** key followed by the **[Enter]** key to measure the OPEN data for calculating the calibration coefficients for table 1. In the same way, measure the OPEN data for calculating the calibration coefficients for tables 2–4.

When you are presented with the message “Set the Scanner's Channel to No.1, and Set Short-Connection.”, set the scanner's channel to 1, short-circuit the test connectors for channel 1, and press the **[y]** key followed by the **[Enter]** key to obtain the SHORT measurement data for calculating the calibration coefficients for table 1. In the same way, measure the SHORT data for calculating the calibration coefficients for tables 2–4.

Finally, the program displays the message “Set the Scanner's Channel to No.1, and Set Load-Connection.” Set the scanner's channel to 1, connect the working standard to the test connectors for channel 1, and press the **[y]** key followed by the **[Enter]** key to measure the LOAD data for calculating the calibration coefficients for table 1. In the same way, measure the LOAD data for calculating the calibration coefficients for table tables 2–4.

When the instrument has finished the above measurement, the calibration function is turned on, and the program displays the message “Set the Dut. Set the Scanner's Channel to No.1. Input external trigger after the **/READY_FOR_TRIG** signal changed to Low level.” Connect the test connectors with a DUT and set the scanner's channel to 1. When the **/READY_FOR_TRIG** signal of the handler interface has changed to Low level, input an external trigger signal from the handler interface. Perform measurement for channels 2–4 in the same way. When the instrument has finished measurement of all channels, it determines bin sorting depending on the results from all of the channels and displays the result of the bin sorting.

When the instrument has finished the 10th cycle of measurement, the program displays the measurement results and then terminates.

Sample Application Programs

Measuring Array (Multi-Element) Components

The program is described in detail below:

Lines 90 to 100	Sets the GPIB address and select code.
Lines 140 to 150	Stores the number of times the measurement is performed (10) and the number of required tables (4) into the Meas_max and Max_tab_no variables, respectively.
Lines 160 to 200	Stores the unit of the signal source level (mV), the measurement frequency (100 MHz), averaging count (1), the signal source level (500 mV), and measurement parameter 1 (Ls) into the Unit\$, Freq, Ave, Pow, and Para1\$ variables, respectively.
Lines 210 to 240	Stores the on/off settings for the screen display (on), screen display update (off), beep (off), and key lock (on) into the Disp\$, Update\$, Beep\$, and Lock\$ variables, respectively.
Lines 280 to 300	Based on the center value (10 nH) of the limit range of the measurement value (Ls) and the relative boundary values ($\pm 10\%$), calculates the lower and upper limits and then stores them into the L_lim and U_lim variables, respectively.
Lines 350 to 400	Stores the R_{dc} measurement lower limit for the OPEN standard (100 Ω) into the Open_l_lim variable and the R_{dc} measurement upper limit for the SHORT standard (25 Ω) into the Short_u_lim variable.

NOTE

The sample program sets the R_{dc} limits for each standard by assuming only typical uses: a lower limit of 100 Ω for the OPEN standard, an upper limit of 25 Ω for the SHORT standard, and no limits for the LOAD standard. To gain more effective protection against operational errors, however, it is recommended that you modify these values based on your actual working standards; for more information, refer to *Preventing operational errors when measuring data for calculating calibration coefficients* on page 40.

Lines 440 to 450	Resets the instrument and then sets the data transfer format to the ASCII format.
Lines 460 to 500	For all the required tables (1 to Max_tab_no), stores the unit of the signal source level into Unit\$, the frequency at measurement point 1 into Freq, averaging count at measurement point 1 into Ave, and the signal source level at measurement point 1 into Pow.
Lines 520 to 530	Turns on list measurement and turns off R_{dc} measurement.
Line 540	Sets measurement parameter 1 to Ls.
Lines 550 to 590	Turns off the result display for measurement parameters 2–4 and measurement signal level monitoring.
Lines 600 to 630	Turns off the screen display, screen display update, and beep.
Lines 640 to 660	Locks the front panel, keyboard, and mouse.
Lines 710 to 820	For all of the required tables (1 to Max_tab_no), configures the calibration kit setup tables in the order of table number.
	Lines 740 to 760: Configures the instrument to use the user-defined calibration kit with values defined for each

measurement point and selects Rs-Ls as the defined parameter.

Lines 770 to 810: Passes control to a subprogram named Inp_data, which obtains the definition values for the load (working standard) from user input. For more information on the Inp_data subprogram, refer to the description in Example 4-1 on page 46.

- Lines 850 to 910 Passes control to a subprogram named FNCal to measure the OPEN data for calculating the calibration coefficients for all of the required tables (1 to Max_tab_no) in the order of table number. For more information on the FNCal subprogram, refer to the description in Example 4-1 on page 46.
- Lines 930 to 990 Passes control to a subprogram named FNCal to measure the SHORT data for calculating the calibration coefficients for all of the required tables (1 to Max_tab_no) in the order of table number.
- Lines 1010 to 1070 Passes control to a subprogram named FNCal to measure the LOAD data for calculating the calibration coefficients for all of the required tables (1 to Max_tab_no) in the order of table number.
- Lines 1090 to 1140 For all of the required tables (1 to Max_tab_no), calculates the calibration coefficients and turns on the calibration function in the order of table number.
- Lines 1180 to 1190 After the trigger system is stopped (turning off the continuous activation of the trigger system), the program sets the trigger source to External trigger.
- Lines 1240 to 1390 Iterates the following steps Meas_max times.
1. Line 1250: Displays the message that prompts you to connect a DUT.
 2. Lines 1260 to 1310: For all of the required tables (1 to Max_tab_no), iterates the following steps in the order of table number.
 - a. Displays the message that prompts you to set an appropriate channel of the scanner, specifies the active table, and executes the **:READ?** command.
 - b. Prompts the user to input an external trigger after the /READY_FOR_TRIG signal of the handler interface changes to Low level. The program waits until the instrument receives an external trigger and completes the measurement cycle.
 - c. Retrieves the measurement result.
 3. Lines 1320 to 1380: Determines bins based on whether the measurement results (Ls) for all channels fall between L_lim and U_lim and displays the classified bins.
- Lines 1430 to 1490 Displays the results of the measurements repeated Meas_max times and bin sorting.

Sample Application Programs

Measuring Array (Multi-Element) Components

Example 14-3

Measuring Array Components (meas_ary.bas)

```
10   DIM Unit$(9),Para1$(9),Bin$(1:10)[20],Buff$(9)
20   DIM Disp$(9),Beep$(9),Lock$(9),Img1$(200),Img2$(200)
30   REAL Freq,Pow,Nom,Lim,L_lim,U_lim,Status,D(1:100,1:4)
40   REAL Load_rs,Load_ls,Load_rdc,Rdc_l_lim,Rdc_u_lim
50   REAL Open_l_lim,Open_u_lim,Short_l_lim,Short_u_lim,Load_l_lim,
Load_u_lim
60   INTEGER Scode,Meas_max,Max_tab_no,Nop,Ave,Result,Tab,I
70   CLEAR SCREEN
80   !
90   ASSIGN @Agt4287a TO 717
100  Scode=7
110  !
120  ! Measurement Condition
130  !
140  Meas_max=10           ! Maximum Measurement Number: 10
150  Max_tab_no=4         ! Maximum Table Number: 4
160  Unit$="V"           ! OSC Level unit: mV
170  Freq=1.0E+8         ! Frequency: 100 MHz
180  Ave=1               ! Averaging Factor: 1
190  Pow=500            ! OSC Level: 500 mV
200  Para1$="LS"        ! Parameter 1: LS
210  Disp$="ON"         ! Display On
220  Update$="OFF"      ! Update Display Off
230  Beep$="OFF"        ! Done/Warn Beeper Off
240  Lock$="ON"         ! Front panel/KBD/Mouse Lock On
250  !
260  ! Limit
270  !
280  Nom=1.0E-8         ! Nominal Value : 10 nH
290  Lim=10             ! Limit : 10 %
300  L_lim=Nom*(1-Lim/100)
310  U_lim=Nom*(1+Lim/100)
320  !
330  ! Rdc Limit for Calibration/Compensation
340  !
350  Open_l_lim=100     ! Open Rdc Lower Limit : 100 ohm
360  Open_u_lim=1.E+9   ! Open Rdc Upper Limit : Dummy
370  Short_l_lim=-1.E+9 ! Short Rdc Lower Limit: Dummy
380  Short_u_lim=25     ! Short Rdc Upper Limit: 25 ohm
390  Load_l_lim=-1.E+9 ! Load Rdc Lower Limit : Dummy
400  Load_u_lim=1.E+9   ! Load Rdc Upper Limit : Dummy
410  !-----
420  ! Measurement Condition Setting
430  !-----
440  OUTPUT @Agt4287a;":SYST:PRES"
450  OUTPUT @Agt4287a;":FORM ASC"
460  FOR Tab=1 TO Max_tab_no
470     OUTPUT @Agt4287a;":SOUR:LIST:TABL ";Tab
480     OUTPUT @Agt4287a;":SOUR:UNIT "&Unit$
490     OUTPUT @Agt4287a;":SOUR:LIST 1,";Freq;",";Ave;",";Pow
500  NEXT Tab
510  !
520  OUTPUT @Agt4287a;":SOUR:LIST:STAT ON"
530  OUTPUT @Agt4287a;":SOUR:LIST:RDC OFF"
540  OUTPUT @Agt4287a;":CALC:PAR1:FORM "&Para1$
550  OUTPUT @Agt4287a;":DISP:TEXT1:CALC2 OFF"
560  OUTPUT @Agt4287a;":DISP:TEXT1:CALC3 OFF"
570  OUTPUT @Agt4287a;":DISP:TEXT1:CALC4 OFF"
580  OUTPUT @Agt4287a;":DISP:TEXT1:CALC11 OFF"
590  OUTPUT @Agt4287a;":DISP:TEXT1:CALC12 OFF"
600  OUTPUT @Agt4287a;":DISP "&Disp$
```

```

610 OUTPUT @Agt4287a;":DISP:UPD "&Update$
620 OUTPUT @Agt4287a;":SYST:BEEP1:STAT "&Beep$
630 OUTPUT @Agt4287a;":SYST:BEEP2:STAT "&Beep$
640 OUTPUT @Agt4287a;":SYST:KLOC "&Lock$
650 OUTPUT @Agt4287a;":SYST:KLOC:KBD "&Lock$
660 OUTPUT @Agt4287a;":SYST:KLOC:MOUS "&Lock$
670 !-----
680 ! Calibration
690 !-----
700 PRINT "##### Load Definition #####"
710 FOR Tab=1 TO Max_tab_no
720     PRINT "----- Table No.";Tab;"-----"
730     OUTPUT @Agt4287a;":SOUR:LIST:TABL ";Tab
740     OUTPUT @Agt4287a;":CORR1:CKIT USER"
750     OUTPUT @Agt4287a;":CORR1:CKIT:LIST ON"
760     OUTPUT @Agt4287a;":CORR1:CKIT:STAN3:FORM RL"
770     CALL Inp_data("Load Rs Value",Load_rs)
780     CALL Inp_data("Load Ls Value",Load_ls)
790     CALL Inp_data("Load Rdc Value",Load_rdc)
800     OUTPUT @Agt4287a;":CORR1:CKIT:STAN3:LIST 1,";Load_rs;",";Load_ls
810     OUTPUT @Agt4287a;":CORR1:CKIT:STAN3:DC ";Load_rdc
820 NEXT Tab
830 !
840 PRINT "##### Measurement for Calibration #####"
850 PRINT "##### Open Data Measurement #####"
860 FOR Tab=1 TO Max_tab_no
870     OUTPUT @Agt4287a;":SOUR:LIST:TABL ";Tab
880     PRINT "Set the Scanner's Channel to No."&VAL$(Tab)&," and"
890     Result=FNCal(@Agt4287a,Scode,"Open",Open_l_lim,Open_u_lim)
900     IF Result<>0 THEN Prog_end
910 NEXT Tab
920 !
930 PRINT "##### Short Data Measurement #####"
940 FOR Tab=1 TO Max_tab_no
950     OUTPUT @Agt4287a;":SOUR:LIST:TABL ";Tab
960     PRINT "Set the Scanner's Channel to No."&VAL$(Tab)&," and"
970     Result=FNCal(@Agt4287a,Scode,"Short",Short_l_lim,Short_u_lim)
980     IF Result<>0 THEN Prog_end
990 NEXT Tab
1000 !
1010 PRINT "##### Load Data Measurement #####"
1020 FOR Tab=1 TO Max_tab_no
1030     OUTPUT @Agt4287a;":SOUR:LIST:TABL ";Tab
1040     PRINT "Set the Scanner's Channel to No."&VAL$(Tab)&," and"
1050     Result=FNCal(@Agt4287a,Scode,"Load",Load_l_lim,Load_u_lim)
1060     IF Result<>0 THEN Prog_end
1070 NEXT Tab
1080 !
1090 FOR Tab=1 TO Max_tab_no
1100     OUTPUT @Agt4287a;":SOUR:LIST:TABL ";Tab
1110     OUTPUT @Agt4287a;":CORR1:COLL:SAVE"
1120     OUTPUT @Agt4287a;":*OPC?"
1130     ENTER @Agt4287a;Buff$
1140 NEXT Tab
1150 !-----
1160 ! Trigger source setting
1170 !-----
1180 OUTPUT @Agt4287a;":ABOR"
1190 OUTPUT @Agt4287a;":TRIG:SOUR EXT"
1200 !-----
1210 ! Measurement
1220 !-----
1230 PRINT "##### Measurement #####"
1240 FOR I=1 TO Meas_max

```

Sample Application Programs

Measuring Array (Multi-Element) Components

```

1250     PRINT "Set the Dut."
1260     FOR Tab=1 TO Max_tab_no
1270         PRINT "Set the Scanner's Channel to No."&VAL$(Tab)&". "
1280         OUTPUT @Agt4287a;":READ? ";Tab
1290         PRINT "Input External Trigger after the /READY_FOR_TRIG signal
changed to Low level."
1300         ENTER @Agt4287a;Status,D(I,Tab)
1310     NEXT Tab
1320     ! BIN sorting
1330     IF (D(I,1)<L_lim OR D(I,1)>U_lim) OR (D(I,2)<L_lim OR
D(I,2)>U_lim) OR (D(I,3)<L_lim OR D(I,3)>U_lim) OR (D(I,4)<L_lim OR
D(I,4)>U_lim) THEN
1340         Bin$(I)="BIN2(N.G.)"
1350     ELSE
1360         Bin$(I)="BIN1(GOOD)"
1370     END IF
1380     PRINT "BIN: "&Bin$(I)
1390 NEXT I
1400     !-----
1410     ! Display
1420     !-----
1430     Img1$="8A,3X,5A,8X,5A,8X,5A,8X,5A,8X,3A"
1440     Img2$="5D,3X,MD.4DE,2X,MD.4DE,2X,MD.4DE,2X,MD.4DE,2X,10A"
1450     PRINT "### Result (Parameter: "&Paral$&"  Frequency: ";Freq;" Hz
Osc Level: ";Pow;"m"&Unit$&") ###"
1460     PRINT USING Img1$;"Dut No. ", "Ch-1", "Ch-2", "Ch-3", "Ch-4", "BIN"
1470     FOR I=1 TO Meas_max
1480         PRINT USING Img2$;I,D(I,1),D(I,2),D(I,3),D(I,4),Bin$(I)
1490     NEXT I
1500     !
1510 Prog_end:END
1520     !=====
1530     ! Calibration Data Measurement Function
1540     !=====
1550 DEF FNCal(@Agt4287a,INTEGER Scode,Standard$,REAL L_lim,REAL U_lim)
1560     DIM Inp_char$(9),Trig_sour$(9),Buff$(9)
1570     REAL Meas_data
1580     INTEGER Err_flag
1590     OUTPUT @Agt4287a;":TRIG:SOUR?"
1600     ENTER @Agt4287a;Trig_sour$
1610     OUTPUT @Agt4287a;":ABOR"
1620     OUTPUT @Agt4287a;":TRIG:SOUR BUS"
1630     OUTPUT @Agt4287a;":INIT:CONT ON"
1640     OUTPUT @Agt4287a;":STAT:OPER:PTR 0"
1650     OUTPUT @Agt4287a;":STAT:OPER:NTR 16"
1660     OUTPUT @Agt4287a;":STAT:OPER:ENAB 16"
1670     OUTPUT @Agt4287a;":*SRE 128"
1680 Cal_meas: !
1690     PRINT "Set "&Standard$&"-Connection."
1700     INPUT "OK? [Y/N]",Inp_char$
1710     IF UPC$(Inp_char$)="Y" THEN
1720         OUTPUT @Agt4287a;":*CLS"
1730         OUTPUT @Agt4287a;":*OPC?"
1740         ENTER @Agt4287a;Buff$
1750         ON INTR Scode GOTO Meas_end
1760         ENABLE INTR Scode;2
1770         SELECT Standard$
1780             CASE "Open"
1790                 OUTPUT @Agt4287a;":CORR1:COLL STAN1"
1800             CASE "Short"
1810                 OUTPUT @Agt4287a;":CORR1:COLL STAN2"
1820             CASE "Load"
1830                 OUTPUT @Agt4287a;":CORR1:COLL STAN3"
1840             CASE "Low Loss C"

```



```

1850         OUTPUT @Agt4287a;":CORR1:COLL STAN4"
1860     END SELECT
1870     OUTPUT @Agt4287a;":TRIG"
1880     PRINT "Now measuring..."
1890 Meas_wait:  GOTO Meas_wait
1900 Meas_end: !
1910     Err_flag=0
1920     SELECT Standard$
1930     CASE "Open"
1940         OUTPUT @Agt4287a;":DATA:RCAD1?"
1950         ENTER @Agt4287a;Rdc
1960         PRINT "Rdc =";ABS(Rdc)
1970         IF ABS(Rdc)<L_lim THEN Err_flag=1
1980     CASE "Short"
1990         OUTPUT @Agt4287a;":DATA:RCAD2?"
2000         ENTER @Agt4287a;Rdc
2010         PRINT "Rdc =";ABS(Rdc)
2020         IF ABS(Rdc)>U_lim THEN Err_flag=1
2030     CASE "Load"
2040         OUTPUT @Agt4287a;":DATA:RCAD3?"
2050         ENTER @Agt4287a;Rdc
2060         PRINT "Rdc =";ABS(Rdc)
2070         IF ABS(Rdc)<L_lim OR ABS(Rdc)>U_lim THEN Err_flag=1
2080     END SELECT
2090     IF Err_flag=0 THEN
2100         PRINT Standard$&" Data Measurement Complete"
2110     ELSE
2120         PRINT "ERROR!!"
2130         GOTO Cal_meas
2140     END IF
2150     OUTPUT @Agt4287a;":TRIG:SOUR "&Trig_sour$
2160     RETURN 0
2170 ELSE
2180     OUTPUT @Agt4287a;":TRIG:SOUR "&Trig_sour$
2190     PRINT "Program Interruption"
2200     RETURN -1
2210 END IF
2220 FNEND
2230 !=====
2240 ! Data Input Function
2250 !=====
2260 SUB Inp_data(Mes$,Inp_val)
2270     DIM Inp_char$(30)
2280     ON ERROR GOTO Inp_start
2290 Inp_start: !
2300     PRINT "Input "&Mes$
2310     INPUT "Value?",Inp_char$
2320     Inp_val=VAL(UPC$(Inp_char$))
2330     PRINT "Input Value: ";Inp_val
2340     INPUT "OK? [Y/N]",Inp_char$
2350     IF UPC$(Inp_char$)<>"Y" THEN Inp_start
2360     OFF ERROR
2370 SUBEND

```

Sample Application Programs
Measuring Array (Multi-Element) Components

15 Command Reference

This chapter provides a GPIB command reference for the Agilent 4287A. The shorthand names of the commands, without the parts that are normally omitted, appear in alphabetical order in this chapter. If you want to search for commands by their full names, see “GPIB commands” in the index. If you want to search for commands by their functionality, see Appendix C, “GPIB Command Table.”

Notational Conventions in this Command Reference

This section describes how to read the description of commands in this chapter.

Syntax

The section headed by “Syntax” describes the syntax to send a command from the external controller to the 4287A. The syntax consists of a command part and a parameter part. The separator between the command part and the parameter part is a space.

When there are several parameters, a comma (,) is used as the separator between adjacent parameters. When the syntax contains an ellipsis between commas, it indicates the omission of one or more parameters; for example, “<numeric 1>, ..., <numeric 4>” means that you should specify four parameters: <numeric 1>, <numeric 2>, <numeric 3>, and <numeric 4>. A string type parameter, such as <string> or <string 1>, must be enclosed with double quotes.

You can omit the lowercase characters of a keyword. For example, you can specify **:SYST:PRES** instead of **:SYSTem:PRESet**.

The definition of symbols used in the syntax are as follows:

- ◊ Characters enclosed by angular brackets are necessary parameters when sending the command.
- [] Parts enclosed by square brackets can be omitted.
- { } Braces indicate that you must select one of the items in this part. Each item is separated by a vertical bar (|).

Description

The section headed by “Description” describes how to use the command or the operation when executed.

Parameters

The section headed by “Parameter” describes the necessary parameters when sending the command. When a parameter is a value type enclosed with ◊, information including description, allowable setting range, and initial value is given; when a parameter is a selection type enclosed with { }, information on each selection item is given.

Query response

The section headed by “Query response” describes the data format read out when a query (data read-out) is available with this command.

Each read-out parameter is enclosed with {}. If there are several items within {} separated by a vertical bar (|), only one of them is read out.

When several parameters are read out, they are separated with a comma (.). An ellipsis between commas (...) indicates that the data of that part is omitted. For example, {numeric 1},...,{numeric 4} indicates that four data items, {numeric 1}, {numeric 2}, {numeric 3}, and {numeric 4}, are read out.

The <newline ><^END> is a program message terminator attached at the end of the parameter.

See also

The “See also” section lists other commands associated with the current command.

Equivalent key sequence

The section headed by “Equivalent key sequence” shows the front panel key that has the same effect as this command.

IEEE Common Commands

This section describes the IEEE common commands.

***CLS**

Syntax

*CLS

Description

Clears the following (No query):

- Error queue
- Status Byte register
- Standard Event Status register
- Operation Status Event register
- Questionable Status Event register

Equivalent key sequence

No equivalent keys are available on the front panel.

***ESE**

Syntax

*ESE <numeric>

*ESE?

Description

Specifies the value of the Standard Event Status enable register.

Parameters

	<numeric>
Description	Sets value in the register
Range	0 to 255
Default	0
Resolution	1

If the parameter is out of the allowable setting range, the bit-by-bit logical product (AND) with 255 (0xff) is set.

Query Response

{numeric}<newline><^END>

See also

*SRE on page 201

Equivalent key sequence

No equivalent keys are available on the front panel.

***ESR?**

Syntax	*ESR?
Description	Returns the value of the Standard Event Status register. Executing this command clears the current register value. (Query only)
Query response	{numeric}<newline><^END>
Equivalent key sequence	No equivalent keys are available on the front panel.

***IDN?**

Syntax	*IDN?
Description	Returns the product information for the 4287A, including the manufacturer, model number, and firmware version number. (Query only)
Query response	{string 1},{string 2},{string 3},{string 4}<newline><^END> The returned data consists of the following items: {string 1} Manufacturer. “Agilent Technologies” is always read out. {string 2} Model number. “4287A” is always read out. {string 3} “00000000” is always read out. {string 4} Firmware version number (example: 01.00).
Equivalent key sequence	No equivalent keys are available on the front panel.

***OPC**

Syntax	*OPC
Description	Sets the OPC bit (bit 0) in the Standard Event Status register when all pending operations are completed. (No query)
Equivalent key sequence	No equivalent keys are available on the front panel.

***OPC?**

Syntax	*OPC?
Description	Reads out 1 when all pending operations are completed. (Query only)
Query response	{1}<newline><^END>
Equivalent key sequence	No equivalent keys are available on the front panel.

***RST**

***RST**

Syntax	*RST
Description	<p>Resets the instrument to its preset state. (No query)</p> <p>This command works similarly to the :SYST:PRES command except that it:</p> <ul style="list-style-type: none">• Turns off the continuous activation of the trigger system.• Sets the data transfer format to ASCII.
See also	<p>:SYST:PRES on page 300</p> <p>:INIT:CONT on page 281</p>
Equivalent key sequence	No equivalent keys are available on the front panel.

*SRE

Syntax *SRE <numeric>
*SRE?

Description Sets the value of the Service Request enable register.

Parameters

	<numeric>
Description	Sets value in the register
Range	0 to 255
Default	0
Resolution	1

If the parameter is out of the allowable setting range, the bit-by-bit logical product (AND) with 255 (0xff) is set. Note that you cannot set bit 6 to 1.

Query response {numeric}<newline><^END>

See also *ESE on page 198
:STAT:OPER:ENAB on page 293

Equivalent key sequence No equivalent keys are available on the front panel.

*STB?

Syntax *STB?

Description Reads out the value of the Status Byte register. (Query only)

NOTE You cannot use the this command in telnet session. This command always reads out 0 when you execute the command in telnet session.

Query response {numeric}<newline><^END>

Equivalent key sequence No equivalent keys are available on the front panel.

***TRG**

***TRG**

Syntax *TRG

Description If the trigger mode is set to GPIB/LAN (BUS, with the **:TRIG:SOUR** command), this command triggers the 4287A and, after completion of measurement, reads out the measurement data.

NOTE This command responds to a query even though it is not suffixed with “?”.

Query response Same as the **:FETC?** command. See the description of **:FETC?**.

See also :FETC? on page 274
:TRIG:SOUR on page 304

Equivalent key sequence No equivalent keys are available on the front panel.

***TST?**

Syntax *TST?

Description Executes the self-test and reads out the result. (Query only)

Query response {1|0}<newline><^END>

	Description
1	The result of the self-test is FAIL.
0	The result of the self-test is PASS.

Equivalent key sequence **[System] - SERVICE MENU - EXECUTE INTERNAL TEST**

***WAI**

Syntax *WAI

Description Waits for all commands sent before completing this command. (No query)

Equivalent key sequence No equivalent keys are available on the front panel.

4287A GPIB Commands

This section covers the GPIB commands available with the 4287A.

:ABOR

Syntax	:ABORt
Description	Resets the trigger system and puts the trigger sequence into idle state; turns off the continuous activation of the trigger system. (No query) For more information on the trigger system and each state, see “Trigger system” on page 66.
See also	:INIT on page 281 :INIT:CONT on page 281
Equivalent key sequence	No equivalent keys are available on the front panel.

:AVER:COUN

Syntax [:SENSe]:AVERage:COUNt <numeric>
[:SENSe]:AVERage:COUNt?

Description This command sets the averaging factor.

The measurement point for single point measurement, specified with the **:SOUR:LIST:POIN** command, in the active table, specified with the **:SOUR:LIST:TABL** command, must be set here.

Execution of this command does not turn off calibration or compensation automatically. If you need to change only the averaging factor after completion of calibration or compensation, use this command.

NOTE To change only the averaging factor after completion of calibration/compensation, you may execute the **:SOUR:LIST** command by specifying the parameter so that only the averaging factor will change with the frequency and signal source level identical to the current settings. In this case, calibration and compensation will be turned off automatically; you will need to rerun calibration and compensation.

Parameters

	<numeric>
Description	Averaging factor
Range	1 to 100
Initial value	1
Resolution	1

If your specified parameter is beyond the valid range, the instrument ignores the parameter and uses either the maximum or minimum value depending on whether the parameter is greater than the upper limit or smaller than the lower limit.

Query response {numeric}<newline><^END>

See also :SOUR:LIST on page 288
:SOUR:LIST:TABL on page 291
:SOUR:LIST:POIN on page 289

Equivalent key sequence **[Setup View]** (Measurement Point Setup display)

:CALC:COMP

Syntax :CALCulate:COMParator[:STATe] {ON|OFF|1|0}
 :CALCulate:COMParator[:STATe]?

Description Turns on or off the comparator. This setting is linked with the on/off status of the handler interface.

Parameters

	Description
ON or 1	Turns on the comparator
OFF or 0 (initial value)	Turns off the comparator

Query response {1|0}<newline><^END>

Equivalent key sequence **[System] - COMPARATOR**

:CALC:COMP:BEEP:COND

Syntax :CALCulate:COMParator:BEEPer:CONDition {FAIL|PASS}
 :CALCulate:COMParator:BEEPer:CONDition?

Description This command is available when the instrument is configured to beep based on the comparator result (i.e., after you have issued the **:SYST:BEEP2:STAT** command by specifying “ON”). The command lets you specify whether the instrument should beep when the DUT fails to meet the comparator sorting criteria (not sorted into any of bins 1 through 13, or sorted into the NO GOOD bin specified with the **:CALC:COMP:OGB** command) or when the DUT satisfies the comparator sorting criteria (sorted into the GOOD bin).

Parameters

	Description
FAIL (initial value)	Instructs the instrument to beep for a DUT that does not meet the sorting criteria.
PASS	Instructs the instrument to beep for a DUT that meets the sorting criteria.

Query response {FAIL|PASS}<newline><^END>

See also :SYST:BEEP2:STAT on page 297
 :CALC:COMP:OGB on page 217

Equivalent key sequence **[System] - BEEPER MENU - BEEP COMPARATOR**

:CALC:COMP:BIN{1-13}

Syntax :CALCulate:COMParator:BIN{1|2|3|4|5|6|7|8|9|10|11|12|13}[:STATe] {ON|OFF|1|0}
:CALCulate:COMParator:BIN{1|2|3|4|5|6|7|8|9|10|11|12|13}[:STATe]?

Description This command is available when the comparator is enabled. It lets you specify whether the instrument should sort DUTs into bin 1 (:BIN1) through bin 13 (:BIN13).

Parameters

	Description
ON or 1	Turns on the sorting feature
OFF or 0 (initial value)	Turns off the sorting feature

Query response {1|0}<newline><^END>

See also :CALC:COMP on page 205

Equivalent key sequence **[Setup View]** (Bin sort setup display)

:CALC:COMP:BIN{1-13}:COND{1-4}:LIM

Syntax :CALCulate:COMParator:BIN {1|2|3|4|5|6|7|8|9|10|11|12|13}:CONDition{1|2|3|4}:LIMit <numeric 1>,<numeric 2>
:CALCulate:COMParator:BIN {1|2|3|4|5|6|7|8|9|10|11|12|13}:CONDition{1|2|3|4}:LIMit?

Description Lets you specify the limit range that applies to each of the four sorting conditions (:COND1 through :COND4) for bin 1 (:BIN1) through bin 13 (:BIN13). The limit range is inclusive of both upper and lower limit values.

The limit range is applied when the parameter specified with the **:CALC:COMP:COND{1-4}:PAR** command is measured at the point specified with the **:CALC:COMP:COND{1-4}:SNUM** command.

If you have issued the **:CALC:COMP:COND{1-4}:MODE** by specifying “DEV” or “PCNT” to configure the instrument to accept a limit range in deviation or percent mode, the instrument assumes that the limit values are relative to the reference value specified with the **:CALC:COMP:COND{1-4}:NOM** command.

Parameters

	<numeric 1>	<numeric 2>
Description	Lower limit value*1	Upper limit value*1
Range	-1E20 to 1E20	-1E20 to 1E20
Default	0	0
Unit	Depends on the sort parameter.	Depends on the sort parameter.
Resolution	1E-20	1E-20

*1. If <numeric 1> is greater than <numeric 2>, the instrument uses <numeric 1> as the upper limit and <numeric 2> as the lower limit.

If your specified parameter is beyond the valid range, the parameter is replaced with either the maximum or minimum value of the valid range depending on whether the parameter is greater than the upper limit or smaller than the lower limit.

Query response {numeric 1}, {numeric2}<newline><^END>
The returned data always lists the lower and upper limits in that order.

See also :CALC:COMP:COND{1-4}:SNUM on page 212
:CALC:COMP:COND{1-4}:PAR on page 211
:CALC:COMP:COND{1-4}:MODE on page 209
:CALC:COMP:COND{1-4}:NOM on page 210
:CALC:COMP:BIN{1-13}:COND{1-4}:LTYP on page 208

Equivalent key sequence **[Setup View]** (Bin sort setup display)

:CALC:COMP:BIN{1-13}:COND{1-4}:LTYP

Syntax	:CALCulate:COMParator:BIN {1 2 3 4 5 6 7 8 9 10 11 12 13}:CONDition{1 2 3 4}:LTYPe {IN OUT ALL} :CALCulate:COMParator:BIN {1 2 3 4 5 6 7 8 9 10 11 12 13}:CONDition{1 2 3 4}:LTYPe?
Description	Lets you set the limit range mode of each of the four sorting conditions (:COND1 through :COND4) for bin 1 (:BIN1) through bin 13 (:BIN13).
Parameters	

	Description
IN	Instructs the instrument to determine that a test has passed the sorting condition where DUTs fall within the limit range (inclusive of the upper and lower limits).
OUT	Instructs the instrument to determine that a test has passed the sorting condition where DUTs do not fall within the limit range (exclusive of the upper and lower limits).
ALL (initial value)	Instructs the instrument to determine that a test has passed the sorting condition where the measurement result is disregarded.

Query response	{IN OUT ALL}<newline><^END>
See also	:CALC:COMP:BIN{1-13}:COND{1-4}:LIM on page 207
Equivalent key sequence	[Setup View] (Bin sort setup display)
	:CALC:COMP:CLE
Syntax	:CALCulate:COMParator:CLEar
Description	Initializes (resets) all the sorting conditions for each comparator bin and a limit range for R _{dc} measurement. (No query)
Equivalent key sequence	[Alt] - [2] - [8] - [2] (when the bin sort setup display is selected by [Setup View])

:CALC:COMP:COND{1-4}:MODE

Syntax :CALCulate:COMParator:CONDition{1|2|3|4}:MODE {ABS|DEV|PCNT}
 :CALCulate:COMParator:CONDition{1|2|3|4}:MODE?

Description Lets you select how to specify the limit range that applies to each of the four sorting conditions (:COND1 through :COND4). This setting applies to all of the bins.

Parameters

	Description
ABS (initial value)	Uses absolute mode, in which the upper and lower limits are specified as absolute values.
DEV	Uses deviation mode, in which the upper and lower limits are specified as deviations relative to the reference value*1.
PCNT	Uses percent mode, in which the upper and lower limits are specified as percentages relative to the reference value*1.

*1. You can use the **:CALC:COMP:COND{1-4}:NOM** command to set the reference value.

Query response {ABS|DEV|PCNT}<newline><^END>

See also :CALC:COMP:COND{1-4}:NOM on page 210

Equivalent key sequence **[Setup View]** (Bin sort setup display)

:CALC:COMP:COND{1-4}:NOM

Syntax :CALCulate:COMParator:CONDition{1|2|3|4}:NOMinal <numeric>
:CALCulate:COMParator:CONDition{1|2|3|4}:NOMinal?

Description Lets you specify the limit range reference value that applies to each of the four sorting conditions (:COND1 through :COND4). The reference value applies to all of the bins if you have issued the **:CALC:COMP:COND{1-4}:MODE** command by specifying “DEV” or “PCNT” to configure the instrument to accept a limit range in deviation or percent mode.

Parameters

	<numeric>
Description	Limit range reference value
Range	-1E20 to 1E20
Default	0
Unit	Depends on measurement parameter used to sort DUTs.
Resolution	1E-20

If your specified parameter is beyond the valid range, the instrument ignores the parameter and uses either the maximum or minimum value depending on whether the parameter is greater than the upper limit or smaller than the lower limit.

Query response {numeric}<newline><^END>

See also :CALC:COMP:COND{1-4}:MODE on page 209

Equivalent key sequence **[Setup View]** (Bin sort setup display)

:CALC:COMP:COND{1-4}:PAR

Syntax

:CALCulate:COMParator:CONDition{1|2|3|4}:PARameter {Z|Y|LS|LP|CS|CP|RS|RP|Q|D|X|G|B|TZR|TZD|TYR|TYD}
 :CALCulate:COMParator:CONDition{1|2|3|4}:PARameter?

Description

Lets you specify the measurement parameter for evaluating each of the four sorting conditions (:COND1 through :COND4). This setting applies to all of the bins.

Parameters

	Description
Z	Evaluates the impedance amplitude absolute value
Y	Evaluates the admittance amplitude absolute value
LS	Evaluates the equivalent series inductance
LP	Evaluates the equivalent parallel inductance
CS	Evaluates the equivalent series capacitance
CP	Evaluates the equivalent parallel capacitance
RS	Evaluates the equivalent series resistance
RP	Evaluates the equivalent parallel resistance
D	Evaluates the dissipation factor
Q	Evaluates the Q value (inverse dissipation factor)
X	Evaluates the equivalent series reactance
G	Evaluates the equivalent parallel conductance
B	Evaluates the equivalent parallel susceptance
TZR	Evaluates the impedance phase (in radians)
TZD	Evaluates the impedance phase (in degrees)
TYR	Evaluates the admittance phase (in radians)
TYD	Evaluates the admittance phase (in degrees)

Sorting condition 1 defaults to Z; sorting condition 2 defaults to TZD; sorting condition 3 defaults to RS; sorting condition 4 defaults to X.

Query response

{Z|Y|LS|LP|CS|CP|RS|RP|Q|D|X|G|B|TZR|TZD|TYR|TYD}<newline><^END>

See also

:CALC:COMP:COND{1-4}:SNUM on page 212

Equivalent key sequence

[Setup View] (Bin sort setup display)

:CALC:COMP:COND{1-4}:SNUM

Syntax :CALCulate:COMParator:CONDition{1|2|3|4}:SNUMber <numeric>
:CALCulate:COMParator:CONDition{1|2|3|4}:SNUMber?

Description Lets you specify the measurement point for each of the four sorting conditions (:COND1 through :COND4). This setting applies to all of the bins.
This setting is reset when settings in the measurement point setup table are changed by execution of **:SOUR:LIST** or **:SOUR:LIST:CLE** commands.

Parameters

	<numeric>
Description	Point number
Range	1 to number of points (up to 32)
Default	1
Resolution	1

If your specified parameter is beyond the valid range, the instrument ignores the parameter and uses either the maximum or minimum value depending on whether the parameter is greater than the upper limit or smaller than the lower limit.

Query response {numeric}<newline><^END>

See also :CALC:COMP:COND{1-4}:PAR on page 211
:SOUR:LIST on page 288
:SOUR:LIST:CLE on page 289

Equivalent key sequence **[Setup View]** (Bin sort setup display)

:CALC:COMP:COUN

Syntax :CALCulate:COMParator:COUNT[:STATe] {ON|OFF|1|0}
 :CALCulate:COMParator:COUNT[:STATe]?

Description Lets you specify whether to use the comparator counter. Enabling this feature causes the instrument to count the number of DUTs put into each bin based on the comparator result.

The maximum count value is 2,147,483,647 ($2^{31}-1$). If this value is exceeded, the count value remains 2,147,483,647 and is not updated.

The count value is not reset by execution of reset commands (***RST** or **:SYST:PRES**).

Parameters

	Description
ON or 1	Enables the bin counter feature
OFF or 0 (initial value)	Disables the bin counter feature

Query response {1|0}<newline><^END>

See also :CALC:COMP:COUN:CLE on page 213
 :CALC:COMP:DATA:BCOU? on page 214

Equivalent key sequence No equivalent keys are available on the front panel.

:CALC:COMP:COUN:CLE

Syntax :CALCulate:COMParator:COUNT:CLEar

Description Initializes the comparator bin counter feature by resetting all of the bin counts to zero. (No query)

Equivalent key sequence No equivalent keys are available on the front panel.

:CALC:COMP:DATA:BCOU?

Syntax :CALCulate:COMParator:DATA:BCOUnt?

Description Returns the count for each bin from the comparator bin counter. The command returns all of the bin counts, regardless of whether the instrument is configured to sort DUTs for each bin. (Query only)

Query response {numeric 1},...,{numeric 14}<newline><^END>

	Description
{numeric 1}	Count for bin 1
{numeric 2}	Count for bin 2
{numeric 3}	Count for bin 3
{numeric 4}	Count for bin 4
{numeric 5}	Count for bin 5
{numeric 6}	Count for bin 6
{numeric 7}	Count for bin 7
{numeric 8}	Count for bin 8
{numeric 9}	Count for bin 9
{numeric 10}	Count for bin 10
{numeric 11}	Count for bin 11
{numeric 12}	Count for bin 12
{numeric 13}	Count for bin 13
{numeric 14}	Count of DUTs that were not sorted into any of bins 1 through 13 (comparator result is 0) or were sorted into NO GOOD bins (set by :CALC:COMP:OGB command). That is the count for a measurement when the /OUT_OF_GOOD_BINS signal of the handler interface changes to LOW level.

See also :CALC:COMP:COUN on page 213
:CALC:COMP:COUN:CLE on page 213
:CALC:COMP on page 205
:CALC:COMP:BIN{1-13} on page 206
:CALC:COMP:OGB on page 217

Equivalent key sequence No equivalent keys are available on the front panel.

:CALC:COMP:DATA:BIN?

Syntax :CALCulate:COMParator:DATA:BIN?

Description Returns the most recent comparator result. (Query only)

Query response {0|1|2|3|4|5|6|7|8|9|10|11|12|13|14}<newline><^END>

	Description
0	Indicates a DUT that was not sorted into any of bins 1 through 13
1	Indicates a DUT that was sorted into bin 1
2	Indicates a DUT that was sorted into bin 2
3	Indicates a DUT that was sorted into bin 3
4	Indicates a DUT that was sorted into bin 4
5	Indicates a DUT that was sorted into bin 5
6	Indicates a DUT that was sorted into bin 6
7	Indicates a DUT that was sorted into bin 7
8	Indicates a DUT that was sorted into bin 8
9	Indicates a DUT that was sorted into bin 9
10	Indicates a DUT that was sorted into bin 10
11	Indicates a DUT that was sorted into bin 11
12	Indicates a DUT that was sorted into bin 12
13	Indicates a DUT that was sorted into bin 13
14	Indicates sort failed (due to a measurement error)

NOTE If the comparator feature is disabled, the command returns the sorting result from when the comparator feature was last enabled. However, the command returns zero if the 4287A has been reset or the comparator feature has not been enabled since turning on the 4287A.

See also :CALC:COMP on page 205

Equivalent key sequence No equivalent keys are available on the front panel.

:CALC:COMP:DATA:RDC?

Syntax :CALCulate:COMParator:DATA:RDC?

Description Returns the most recent R_{dc} limit evaluation result when the R_{dc} measurement feature and the comparator feature are enabled. (Query only)

Query response

	Description
0	Indicates that R_{dc} was beyond the limit
1	Indicates that R_{dc} was within the limit

NOTE

If either the R_{dc} measurement feature or the comparator feature is disabled, the command returns the previous sorting result. However, the command returns zero if the 4287A has been reset or the R_{dc} limit evaluation has not been executed since turning on the 4287A.

See also :SOUR:LIST:RDC on page 290
:CALC:COMP on page 205
:CALC:COMP:RDC:LIM on page 218
:DATA:RDC? on page 261

Equivalent key sequence No equivalent keys are available on the front panel.

:CALC:COMP:OGB

Syntax :CALCulate:COMParator:OGBins <numeric>
 :CALCulate:COMParator:OGBins?

Description Specifies the boundary between good and bad bins (the OUT_OF_GOOD_BINS line) by specifying the number of the good bin that is adjacent to the boundary. All bin numbers that are equal to or smaller than the specified bin number indicate good bins while those larger than the specified number represent bad bins.

NOTE When a DUT is sorted into a bad bin, the handler interface output signal /OUT_OF_GOOD_BINS becomes active (Low). Also, the /OUT_OF_GOOD_BINS signal becomes active when a DUT is not sorted into any of the bins 1 through 13.

Parameters

	<numeric>
Description	Number of good bin to be adjacent to the boundary
Range	1 to 13
Default	10
Resolution	1

If your specified parameter is beyond the valid range, the instrument ignores the parameter and uses either the maximum or minimum value depending on whether the parameter is greater than the upper limit or smaller than the lower limit.

Query response {numeric}<newline><^END>

Equivalent key sequence **[Alt] - [2] - [7] - ** (when the bin sort setup display is selected by **[Setup View]**)

:CALC:COMP:RDC:LIM

Syntax :CALCulate:COMParator:RDC:LIMit <numeric 1>,<numeric 2>
:CALCulate:COMParator:RDC:LIMit?

Description Sets the limit range for the R_{dc} limit evaluation. The limit range is inclusive of both upper and lower limit values.

Parameters

	<numeric 1>	<numeric 2>
Description	Lower limit value* ¹	Upper limit value* ¹
Range	-1E20 to 1E20	-1E20 to 1E20
Default	0	10000
Unit	Ω (ohm)	Ω (ohm)
Resolution	1E-20	1E-20

*1. If <numeric 1> is greater than <numeric 2>, the instrument uses <numeric 1> as the upper limit and <numeric 2> as the lower limit.

If your specified parameter is beyond the valid range, the instrument ignores the parameter and uses either the maximum or minimum value depending on whether the parameter is greater than the upper limit or smaller than the lower limit.

Query response {numeric 1}, {numeric2}<newline><^END>

The returned data always lists the lower and upper limits in that order.

See also :SOUR:LIST:RDC on page 290

Equivalent key sequence **[Setup View]** (Bin sort setup display)

:CALC:EXAM:GET?

Syntax :CALCulate[:MATH]:EXAMine:GET? <numeric 1>,<numeric 2>

Description Performs statistical processing at the specified measurement point for the specified measurement item and then returns the results. (Query only)

The number assigned to a measurement item is used to specify it. The number is assigned to only displayed items according to the following order.

- Measurement parameter 1
- Measurement parameter 2
- Measurement parameter 3
- Measurement parameter 4
- Test signal current level monitor
- Test signal voltage level monitor
- R_{dc}

For example, when the measurement parameter 1, the test signal current level, and the R_{dc} are displayed and the rest of the items are not displayed, the correspondence between the numbers and the measurement items is as follows.

- 1: Measurement parameter 1
- 2: Test signal current level monitor
- 3: R_{dc}

When the measurement data is logging to the volatile memory (RAM) at each measurement (that is, when the logged data size has not yet reached maximum), the data logging for statistical analysis is interrupted by execution of this command.

This command is valid only when the RAM contains measurement data for statistical analysis (that is, when the **:CALC:EXAM:STAR** command is not executed); otherwise, the command does not return query response and an error is generated.

If the obtained data number during a measurement is changed by a change in list/single-point measurement or by a change in the number of displayed measurement items after data logging is started, this command returns an invalid result and an error may be generated.

Parameters

	<numeric 1>	<numeric 2>
Description	Measurement item number	Measurement point number *1
Range	1 to number of displayed measurement items (up to 7)	1 to number of points (up to 32)
Resolution	1	1

*1. In one-point measurement, 1 is used as this parameter at all measurement points.

If your specified parameter is beyond the valid range, the instrument ignores the parameter and uses either the maximum or minimum value depending on whether the parameter is greater than the upper limit or smaller than the lower limit.

Command Reference

:CALC:EXAM:POIN?

Query response	{numeric 1},...,{numeric 10}<newline><^END> The returned data consists of the following 10 statistical analysis items: {numeric 1} Average of measurement data set from normal measurements (that is, measurements when overload or R_{dc} out of range is not detected) {numeric 2} Standard deviation of measurement data set from normal measurements (σ) {numeric 3} $3 \times \sigma$ /average of measurement data set from normal measurements {numeric 4} Minimum value of measurement data set from normal measurements {numeric 5} Maximum value of measurement data set from normal measurements {numeric 6} Number of normal measurements (number of data items contained in measurement data set from normal measurements) {numeric 7} Number of measurements when R_{dc} out of range is detected {numeric 8} Number of measurements when overload is detected {numeric 9} Number of abnormal measurements (number of measurements when overload or R_{dc} out of range is detected) {numeric 10} Total number of measurements
See also	:CALC:EXAM:STAR on page 222
Equivalent key sequence	[Prmtr]-DATA EXAM - {PRMTR-1 PRMTR-2 PRMTR-3 PRMTR-4 I-mon V-mon Rdc} :CALC:EXAM:POIN?
Syntax	:CALCulate[:MATH]:EXAMine[:MEMory]:POINT?
Description	Returns the number of measurement data logged in the volatile memory (RAM). (Query only)
Query response	{numeric}<newline><^END>
Equivalent key sequence	No equivalent keys are available on the front panel.

:CALC:EXAM:SIZE

Syntax :CALCulate[:MATH]:EXAMine[:MEMory]:SIZE <numeric>
:CALCulate[:MATH]:EXAMine[:MEMory]:SIZE?

Description Sets the maximum number of measurement data logged in the volatile memory for statistical analysis. The maximum number must be set as $Param \times Nop \times Times$ where:

Param Number of displayed measurement items covering measurement parameters 1 through 4, test signal current/voltage level and R_{dc}

Nop Number of measurement points in one measurement (that is, 1 during single-point measurement or the number of measurement points in the active table during list measurement)

Times Number of measurements needed for statistical analysis

Parameters

	<numeric>
Description	Maximum number of measurement data
Range	1 to 2,400,000
Default	3000
Resolution	Obtained data number at one measurement ($Param \times Nop$)

If your specified parameter is beyond the valid range, the instrument ignores the parameter and uses either the maximum or minimum value depending on whether the parameter is greater than the upper limit or smaller than the lower limit.

If your specified parameter is not a multiple of ($Param \times Nop$), the instrument ignores the parameter and uses the next highest acceptable value above the specified parameter.

Query response {numeric}<newline><^END>

Equivalent key sequence **[Trigger Mode] - DATA LOGGING - MAX LOG SIZE**

:CALC:EXAM:STAR

Syntax :CALCulate[:MATH]:EXAMine[:MEMory]:STARt

Description Removes all measurement data logged in the volatile memory for statistical analysis and then starts logging measurement data to the volatile memory (RAM).
Logging of measurement data is finished when the number of logged data reaches maximum or the **:CALC:EXAM:GET?** command is executed. (No query)

See also :CALC:EXAM:SIZE on page 221
:CALC:EXAM:GET? on page 219

Equivalent key sequence **[Trigger Mode] - DATA LOGGING - START LOGGING**

:CALC:PAR{1-4}:EXPR:CENT

Syntax :CALCulate:PARAMeter{1|2|3|4}[:MATH]:EXPRession:CENTer <numeric>
:CALCulate:PARAMeter{1|2|3|4}[:MATH]:EXPRession:CENTer?

Description Specifies the reference value for deviation-mode display of measurement results for each of the parameters 1 (:PAR1) through 4 (:PAR4).

Parameters

	<numeric>
Description	Reference value
Range	-1E20 to 1E20
Default	0
Unit	Depends on measurement parameter
Resolution	1E-18

If your specified parameter is beyond the valid range, the instrument ignores the parameter and uses either the maximum or minimum value depending on whether the parameter is greater than the upper limit or smaller than the lower limit.

Query response {numeric}<newline><^END>

See also :CALC:PAR{1-4}:EXPR:NAME on page 223
:CALC:PAR{1-4}:EXPR:STAT on page 223

Equivalent key sequence **[Prmtr] - SETUP DATA MATH - {PRMTR-1|PRMTR-2|PRMTR-3|PRMTR-4} - CENTER**

:CALC:PAR{1-4}:EXPR:NAME

Syntax :CALCulate:PARAmeter{1|2|3|4}[:MATH]:EXPRession:NAME {DEV|PCNT}
 :CALCulate:PARAmeter{1|2|3|4}[:MATH]:EXPRession:NAME?

Description Specifies the format for deviation-mode display of measurement results for each of the parameters 1 (:PAR1) through 4 (:PAR4).

Parameters

	Description
DEV (initial value)	Instructs the instrument to display the difference between the measured value and the reference value ^{*1} (measured value minus reference value).
PCNT	Instructs the instrument to display the differential percentage ^{*2} between the measured value and the reference value ^{*1} .

- *1. Use the **:CALC:PAR{1-4}:EXPR:CENT** command to set the reference value.
- *2. (measured value - reference value) / reference value × 100

Query response {DEV|PCNT}<newline><^END>

See also :CALC:PAR{1-4}:EXPR:CENT on page 222

Equivalent key sequence **[Pmtr] - SETUP DATA MATH - {PRMTR-1|PRMTR-2|PRMTR-3|PRMTR-4} - STAT**

:CALC:PAR{1-4}:EXPR:STAT

Syntax :CALCulate:PARAmeter{1|2|3|4}[:MATH]:EXPRession:STATe {ON|OFF|1|0}
 :CALCulate:PARAmeter{1|2|3|4}[:MATH]:EXPRession:STATe?

Description Specifies whether to use deviation mode to display measurement results for each of the parameters 1 (:PAR1) through 4 (:PAR4). In deviation mode, measurement results are expressed as deviations relative to the reference value (specified with the **:CALC:PAR{1-4}:EXPR:CENT** command).

Parameters

	Description
ON or 1	Turns on deviation mode
OFF or 0 (initial value)	Turns off deviation mode (i.e., instructs the instrument to display measurement results as absolute values)

Query response {1|0}<newline><^END>

See also :CALC:PAR{1-4}:EXPR:CENT on page 222

Equivalent key sequence **[Pmtr] - SETUP DATA MATH - {PRMTR-1|PRMTR-2|PRMTR-3|PRMTR-4} - STAT**

:CALC:PAR{1-4}:FORM

Syntax :CALCulate:PARAmeter{1|2|3|4}:FORMat {Z|Y|LS|LP|CS|CP|RS|RP|Q|D|X|G|B|TZR|TZD|TYR|TYD}
 :CALCulate:PARAmeter{1|2|3|4}:FORMat?

Description Specifies the measurement parameter to use as each of the parameters 1 (:PAR1) through 4 (:PAR4). You can assign these parameters independently of other parameter settings.

Parameters

	Description
Z	Uses absolute value of impedance amplitude as measurement parameter
Y	Uses absolute value of admittance amplitude as measurement parameter
LS	Uses equivalent series inductance as measurement parameter
LP	Uses equivalent parallel inductance as measurement parameter
CS	Uses equivalent series capacitance as measurement parameter
CP	Uses equivalent parallel capacitance as measurement parameter
RS	Uses equivalent series resistance as measurement parameter
RP	Uses equivalent parallel resistance as measurement parameter
D	Uses dissipation factor as measurement parameter
Q	Uses Q value (inverse dissipation factor) as measurement parameter
X	Uses equivalent series reactance as measurement parameter
G	Uses the equivalent parallel conductance as the measurement parameter.
B	Uses equivalent parallel susceptance as measurement parameter
TZR	Uses impedance phase (in radians) as measurement parameter
TZD	Uses impedance phase (in degrees) as measurement parameter
TYR	Uses admittance phase (in radians) as measurement parameter
TYD	Uses admittance phase (in degrees) as measurement parameter

Parameter 1 defaults to Z; parameter 2 defaults to TZD; parameter 3 defaults to RS; parameter 4 defaults to X.

Query response {Z|Y|LS|LP|CS|CP|RS|RP|Q|D|X|G|B|TZR|TZD|TYR|TYD}<newline><^END>

Equivalent key sequence **[Prmtr] - SETUP MEAS PRMTRS - {PRMTR-1|PRMTR-2|PRMTR-3|PRMTR-4} - {Z|Y|Ls|Lp|Cs|Cp|Rs|Rp|Q|D|X|G|B|θz(rad)|θz(deg)|θy(rad)|θy(deg)}**

:CORR1?

Syntax [:SENSe]:CORRection1[:STATe]?

Description Returns the on/off status of the calibration mechanism.

You cannot directly turn on or off the calibration mechanism. Instead, the calibration mechanism is automatically turned on when you issue the **:CORR1:COLL:SAVE** command after measuring the data required for calculating calibration coefficients. (Query only)

Query response {1|0}<newline><^END>

	Description
1	Calibration mechanism is on
0	Calibration mechanism is off

See also :CORR1:COLL:SAVE on page 240

Equivalent key sequence No equivalent keys are available on the front panel.

:CORR1:CKIT

Syntax [:SENSe]:CORRection1:CKIT {DEFault|USER}
[:SENSe]:CORRection1:CKIT?

Description Configures the instrument to use the specified calibration kit to obtain the data necessary for calculating calibration coefficients. You can specify the 4287A Option 007 (16195B 7-mm calibration kit) or your custom calibration kit.

Parameters

	Description
DEFault (initial value)	Configures instrument to use default 7 mm calibration kit
USER	Configures instrument to use user-defined calibration kit

Query response {DEF|USER}<newline><^END>

Equivalent key sequence **[Setup View]** (Calibration kit setup display)

:CORR1:CKIT:LIST

Syntax [:SENSe]:CORRection1:CKIT:LIST[:STATe] {ON|OFF|1|0}
[:SENSe]:CORRection1:CKIT:LIST[:STATe]?

Description Specifies whether the instrument should allow each standard of the user-defined calibration kit to be defined on a point-by-point basis or based on a fixed value that does not depend on a particular measurement point. In the latter case, the same value is applied to all measurement points.

If the instrument has already been configured to accept point-by-point definitions, using this command to reconfigure it to use a fixed value changes the standard values of all measurement points to that of measurement point number 1.

Parameters

	Description
ON or 1	Configures instrument to accept point-by-point definitions
OFF or 0 (initial value)	Configures instrument to accept definitions based on a fixed value (the same value is applied to all measurement points)

Query response {1|0}<newline><^END>

Equivalent key sequence **[Setup View]** (Calibration kit setup display)

:CORR1:CKIT:STAN1:DC

Syntax [:SENSe]:CORRection1:CKIT:STANdard1:DC <numeric>
[:SENSe]:CORRection1:CKIT:STANdard1:DC?

Description One of the commands for setting up the OPEN standard of the user-defined calibration kit. Use this command to define the conductance value to use during R_{dc} measurement.

Parameters

	<numeric>
Description	Conductance value
Range	-1E6 to 1E6
Default	0
Unit	S (siemens)
Resolution	1E-18

If your specified parameter is beyond the valid range, the instrument ignores the parameter and uses either the maximum or minimum value depending on whether the parameter is greater than the upper limit or smaller than the lower limit.

Query response {numeric}<newline><^END>

See also :CORR1:CKIT:STAN2:DC on page 230
:CORR1:CKIT:STAN3:DC on page 233

Equivalent key sequence **[Setup View]** (Calibration kit setup display)

:CORR1:CKIT:STAN1:EDEL

Syntax [:SENSe]:CORRection1:CKIT:STANdard1:EDELay[:TIME] <numeric>
[:SENSe]:CORRection1:CKIT:STANdard1:EDELay[:TIME]?

Description Defines the offset delay time of the OPEN standard of the user-defined calibration kit. This value applies to all measurement points regardless of the setting specified with the :CORR1:CKIT:LIST command on page 226.

Parameters

	<numeric>
Description	Offset delay time
Range	-1E6 to 1E6
Default	0
Unit	s (seconds)
Resolution	1E-18

If your specified parameter is beyond the valid range, the instrument ignores the parameter and uses either the maximum or minimum value depending on whether the parameter is greater than the upper limit or smaller than the lower limit.

Query response {numeric}<newline><^END>

See also :CORR1:CKIT:STAN2:EDEL on page 231
:CORR1:CKIT:STAN3:EDEL on page 234

Equivalent key sequence **[Setup View]** (Calibration kit setup display)

:CORR1:CKIT:STAN1:LIST

Syntax [:SENSe]:CORRection1:CKIT:STANdard1:LIST <numeric 1>,<numeric 2>,<numeric 3>
[:SENSe]:CORRection1:CKIT:STANdard1:LIST? <numeric 1>

Description Defines the equivalent parallel conductance (G) and equivalent parallel capacitance (Cp) values at a specified measurement point for the OPEN standard of the user-defined calibration kit.

If you have issued the **:CORR1:CKIT:LIST** command by specifying “OFF” to configure the instrument to accept fixed-value definitions for each standard of the user-defined calibration kit, specifying a particular measurement point has no effect; regardless of the measurement point number specified, the same value is applied to all measurement points. Similarly, when you issue this command in its query form, the command returns the same value regardless of the specified measurement point number. Nevertheless, you must specify a valid measurement point number (for example, “1”) so that the command can successfully execute.

Parameters

	<numeric 1>	<numeric 2>	<numeric 3>
Description	Measurement point number	G	Cp
Range	1 to number of measurement points	-1E6 to 1E6	-1E6 to 1E6
Default	1	0	8.2E-14
Unit	None	S (siemens)	F (farad)
Resolution	1	1E-18	1E-18

If your specified parameter is beyond the valid range, the instrument ignores the parameter and uses either the maximum or minimum value depending on whether the parameter is greater than the upper limit or smaller than the lower limit.

Query response {numeric 2},{numeric 3}<newline><^END>

See also :CORR1:CKIT:LIST on page 226
:CORR1:CKIT:STAN2:LIST on page 232
:CORR1:CKIT:STAN3:LIST on page 236

Equivalent key sequence **[Setup View]** (Calibration kit setup display)

:CORR1:CKIT:STAN2:DC

Syntax [:SENSe]:CORRection1:CKIT:STANdard2:DC <numeric>
[:SENSe]:CORRection1:CKIT:STANdard2:DC?

Description Defines the dc resistance (R_{dc}) value of the SHORT standard of the user-defined calibration kit.

Parameters

	<numeric>
Description	R_{dc}
Range	-1E6 to 1E6
Default	0
Unit	Ω (ohm)
Resolution	1E-18

If your specified parameter is beyond the valid range, the instrument ignores the parameter and uses either the maximum or minimum value depending on whether the parameter is greater than the upper limit or smaller than the lower limit.

Query response {numeric}<newline><^END>

See also :CORR1:CKIT:STAN1:DC on page 227
:CORR1:CKIT:STAN3:DC on page 233

Equivalent key sequence **[Setup View]** (Calibration kit setup display)

:CORR1:CKIT:STAN2:EDEL

Syntax [:SENSe]:CORRection1:CKIT:STANdard2:EDELay[:TIME] <numeric>
[:SENSe]:CORRection1:CKIT:STANdard2:EDELay[:TIME]?

Description Defines the offset delay time of the SHORT standard of the user-defined calibration kit. This value applies to all measurement points regardless of the setting specified with the :CORR1:CKIT:LIST command on page 226.

Parameters

	<numeric>
Description	Offset delay time
Range	-1E6 to 1E6
Default	0
Unit	s (seconds)
Resolution	1E-18

If your specified parameter is beyond the valid range, the instrument ignores the parameter and uses either the maximum or minimum value depending on whether the parameter is greater than the upper limit or smaller than the lower limit.

Query response {numeric}<newline><^END>

See also :CORR1:CKIT:STAN1:EDEL on page 228
:CORR1:CKIT:STAN3:EDEL on page 234

Equivalent key sequence **[Setup View]** (Calibration kit setup display)

:CORR1:CKIT:STAN2:LIST

Syntax [:SENSe]:CORRection1:CKIT:STANdard2:LIST <numeric 1>,<numeric 2>,<numeric 3>
[:SENSe]:CORRection1:CKIT:STANdard2:LIST? <numeric 1>

Description Defines the equivalent series resistance (Rs) and equivalent series inductance (Ls) values at a specified measurement point for the SHORT standard of the user-defined calibration kit.

If you have issued the **:CORR1:CKIT:LIST** command by specifying “OFF” to configure the instrument to accept fixed-value definitions for each standard of the user-defined calibration kit, specifying a particular measurement point has no effect; regardless of the measurement point number specified, the same value is applied to all measurement points. Similarly, when you issue this command in its query form, the command returns the same value regardless of the value you assign to a particular measurement number. Nevertheless, you must specify a valid measurement point number (for example, “1”) so that the command can successfully execute.

Parameters

	<numeric 1>	<numeric 2>	<numeric 3>
Description	Measurement point number	Rs	Ls
Range	1 to number of points (up to 32)	0 to 1E6	0 to 1E6
Default	1	0	0
Unit	None	Ω (ohm)	H (henry)
Resolution	1	1E-18	1E-18

If your specified parameter is beyond the valid range, the instrument ignores the parameter and uses either the maximum or minimum value depending on whether the parameter is greater than the upper limit or smaller than the lower limit.

Query response {numeric 2},{numeric 3}<newline><^END>

See also :CORR1:CKIT:LIST on page 226
:CORR1:CKIT:STAN1:LIST on page 229
:CORR1:CKIT:STAN3:LIST on page 236

Equivalent key sequence **[Setup View]** (Calibration kit setup display)

:CORR1:CKIT:STAN3:DC

Syntax [:SENSe]:CORRection1:CKIT:STANdard3:DC <numeric>
[:SENSe]:CORRection1:CKIT:STANdard3:DC?

Description Defines the dc resistance (R_{dc}) value of the LOAD standard of the user-defined calibration kit.

Parameters

	<numeric>
Description	R_{dc}
Range	-1E6 to 1E6
Default	50
Unit	Ω (ohm)
Resolution	1E-18

If your specified parameter is beyond the valid range, the instrument ignores the parameter and uses either the maximum or minimum value depending on whether the parameter is greater than the upper limit or smaller than the lower limit.

Query response {numeric}<newline><^END>

See also :CORR1:CKIT:STAN1:DC on page 227
:CORR1:CKIT:STAN2:DC on page 230

Equivalent key sequence **[Setup View]** (Calibration kit setup display)

:CORR1:CKIT:STAN3:EDEL

Syntax [:SENSe]:CORRection1:CKIT:STANdard3:EDELay[:TIME] <numeric>
[:SENSe]:CORRection1:CKIT:STANdard3:EDELay[:TIME]?

Description Defines the offset delay time of the LOAD standard of the user-defined calibration kit. This value applies to all measurement points regardless of the setting specified with the :CORR1:CKIT:LIST command on page 226.

Parameters

	<numeric>
Description	Offset delay time
Range	-1E6 to 1E6
Default	0
Unit	s (seconds)
Resolution	1E-18

If your specified parameter is beyond the valid range, the instrument ignores the parameter and uses either the maximum or minimum value depending on whether the parameter is greater than the upper limit or smaller than the lower limit.

Query response {numeric}<newline><^END>

See also :CORR1:CKIT:STAN1:EDEL on page 228
:CORR1:CKIT:STAN2:EDEL on page 231

Equivalent key sequence **[Setup View]** (Calibration kit setup display)

:CORR1:CKIT:STAN3:FORM

Syntax [:SENSe]:CORRection1:CKIT:STANdard3:FORMat {RL|LQF|CDF}
[:SENSe]:CORRection1:CKIT:STANdard3:FORMat?

Description Defines the parameter type to use when defining the values specific to the LOAD standard of the user-defined calibration kit. When the parameter type is changed, the LOAD standard values are reset to the initial values. Therefore, define the LOAD standard values after the parameter type is defined by this command.

Parameters

	Description
RL (initial value)	Instructs instrument to accept definitions based on equivalent series resistance (Rs) and equivalent series inductance (Ls) values
LQF	Instructs instrument to accept definitions based on equivalent series inductance (Ls) and quality factor (Q) values
CDF	Instructs instrument to accept definitions based on equivalent parallel capacitance (Cp) and dissipation factor (D) values

Query response {RL|LQF|CDF}<newline><^END>

See also :CORR1:CKIT:STAN3:LIST on page 236

Equivalent key sequence **[Setup View]** (Calibration kit setup display)

:CORR1:CKIT:STAN3:LIST

Syntax [:SENSe]:CORRection1:CKIT:STANdard3:LIST <numeric 1>,<numeric 2>,<numeric 3>
 [:SENSe]:CORRection1:CKIT:STANdard3:LIST? <numeric 1>

Description Defines the impedance values at a specified measurement point for the LOAD standard values of the user-defined calibration kit. To specify the parameter type to use when defining the LOAD standard values, use the **:CORR1:CKIT:STAN3:FORM** command to instruct the instrument to accept definitions based on equivalent series resistance (Rs) and equivalent series inductance (Ls) values; equivalent series inductance (Ls) and quality factor (Q) values; or equivalent parallel capacitance (Cp) and dissipation factor (D) values.

If you have issued the **:CORR1:CKIT:LIST** command by specifying “OFF” to configure the instrument to accept fixed-value definitions for each standard of the user-defined calibration kit, specifying a particular measurement point has no effect; regardless of the measurement point number specified, the same value is applied to all measurement points. Similarly, when you issue this command in its query form, the command returns the same value regardless of the value you assign to a particular measurement number. Nevertheless, you must specify a valid measurement point number (for example, “1”) so that the command can successfully execute.

Parameters

- Definitions based on Rs and Ls values

	<numeric 1>	<numeric 2>	<numeric 3>
Description	Measurement point number	Rs	Ls
Range	1 to number of points (up to 32)	-1E6 to 1E6	-1E6 to 1E6
Default	1	50	0
Unit	None	Ω (ohm)	H (henry)
Resolution	1	1E-18	1E-18

- Definitions based on Ls and Q values

	<numeric 1>	<numeric 2>	<numeric 3>
Description	Measurement point number	Ls	Q
Range	1 to number of points (up to 32)	-1E6 to 1E6	-1E6 to 1E6
Default	1	0	0
Unit	None	H (henry)	None
Resolution	1	1E-18	1E-18

- Definitions based on Cp and D values

	<numeric 1>	<numeric 2>	<numeric 3>
Description	Measurement point number	Cp	D
Range	1 to number of points (up to 32)	-1E6 to 1E6	-1E6 to 1E6
Default	1	0	0
Unit	None	F (farad)	None
Resolution	1	1E-18	1E-18

If your specified parameter is beyond the valid range, the instrument ignores the parameter and uses either the maximum or minimum value depending on whether the parameter is greater than the upper limit or smaller than the lower limit.

Query response {numeric 2},{numeric 3}<newline><^END>

See also :CORR1:CKIT:LIST on page 226
:CORR1:CKIT:STAN3:FORM on page 235
:CORR1:CKIT:STAN1:LIST on page 229
:CORR1:CKIT:STAN2:LIST on page 232

Equivalent key sequence **[Setup View]** (Calibration kit setup display)

:CORR1:COLL

Syntax [:SENSe]:CORRection1:COLLect[:ACQuire] {STAN1|STAN2|STAN3|STAN4}

Description Obtains the data for calculating the calibration coefficients to use during impedance measurement and the calibration coefficients to use during R_{dc} measurement performed with the specified standard. When a low-loss capacitor is specified as the standard, the command obtains the data for calculating the calibration coefficient for impedance measurement only.

The data is obtained for only the active table. (No query)

NOTE The measurement to obtain the data is not started by execution of this command. You must trigger the instrument after execution of this command when the trigger source is not set to internal trigger (Int).

Parameters

	Description
STAN1	OPEN standard
STAN2	SHORT standard
STAN3	LOAD standard
STAN4	Low-loss capacitor

See also :CORR1:COLL:DC on page 239
:CORR1:COLL:RF on page 240

Equivalent key sequence [Cal/Compen] - CAL DIALOG

:CORR1:COLL:DC

Syntax [:SENSe]:CORRection1:COLLect[:ACQuire]:DC {STAN1|STAN2|STAN3}

Description Obtains the data for calculating the calibration coefficients to use during R_{dc} measurement performed with the specified standard. The data is obtained for only the active table. (No query)

NOTE The measurement to obtain the data is not started by execution of this command. You must trigger the instrument after execution of this command when the trigger source is not set to internal trigger (Int).

Parameters

	Description
STAN1	OPEN standard
STAN2	SHORT standard
STAN3	LOAD standard

See also :CORR1:COLL on page 238
 :CORR1:COLL:RF on page 240

Equivalent key sequence **[Cal/Compen] - CAL DIALOG**

:CORR1:COLL:RF

Syntax [:SENSe]:CORRection1:COLLect[:ACQuire]:RF {STAN|STAN2|STAN3|STAN4}

Description Obtains the data for calculating the calibration coefficients to use during impedance measurement performed with the specified standard. The data is obtained for only the active table. (No query)

NOTE The measurement to obtain the data is not started by execution of this command. You must trigger the instrument after execution of this command when the trigger source is not set to internal trigger (Int).

Parameters

	Description
STAN1	OPEN standard
STAN2	SHORT standard
STAN3	LOAD standard
STAN4	Low-loss capacitor

See also :CORR1:COLL on page 238
:CORR1:COLL:DC on page 239

Equivalent key sequence No equivalent keys are available on the front panel.

:CORR1:COLL:SAVE

Syntax [:SENSe]:CORRection1:COLLect:SAVE

Description Calculates the calibration coefficients based on the data obtained through the **:CORR1:COLL** command, or a similar command, and turns on the calibration mechanism. You can use the **:CORR1?** command to check the on/off status of the calibration mechanism.

This command is valid only after you have obtained all the data (for both impedance and DC) necessary for all standards (OPEN, SHORT, and LOAD); otherwise, the command fails and an error is generated. (No query)

See also :CORR1? on page 225
:CORR1:COLL on page 238
:CORR1:COLL:DC on page 239
:CORR1:COLL:RF on page 240

Equivalent key sequence [Cal/Compen] - CAL DIALOG

:CORR2:CKIT

Syntax
[:SENSe]:CORRection2:CKIT {DEfault|USER}
[:SENSe]:CORRection2:CKIT?

Description
Configures the 4287A to use its predefined values for the compensation kit or accept user-defined values when obtaining the data for calculating the compensation coefficients.

Parameters

	Description
DEfault (initial value)	Instructs instrument to use its predefined values
USER	Instructs instrument to accept user-defined values

Query response
{DEf|USER}<newline><^END>

Equivalent key sequence
[Setup View] (Compensation kit setup display)

:CORR2:CKIT:LIST

Syntax
[:SENSe]:CORRection2:CKIT:LIST[:STATe] {ON|OFF|1|0}
[:SENSe]:CORRection2:CKIT:LIST[:STATe]?

Description
Specifies whether the instrument should allow each standard of the compensation kit to be defined on a point-by-point basis or based on a fixed value that does not depend on a particular measurement point. In the latter case, the same value is applied to all measurement points.

If the instrument has already been configured to accept point-by-point definitions, using this command to reconfigure it to use a fixed value changes the standard values of all measurement points to that of measurement point number 1.

Parameters

	Description
ON or 1	Configures instrument to accept point-by-point definitions
OFF or 0 (initial value)	Configures instrument to accept definitions based on a fixed value (the same value is applied to all measurement points)

Query response
{1|0}<newline><^END>

Equivalent key sequence
[Setup View] (Compensation kit setup display)

:CORR2:CKIT:STAN1:DC

Syntax [:SENSe]:CORRection2:CKIT:STANdard1:DC <numeric>
[:SENSe]:CORRection2:CKIT:STANdard1:DC?

Description Defines the conductance to use during R_{dc} measurement for the OPEN standard of the compensation kit.

Parameters

	<numeric>
Description	Conductance value
Range	-1E6 to 1E6
Default	0
Unit	S (siemens)
Resolution	1E-18

If your specified parameter is beyond the valid range, the instrument ignores the parameter and uses either the maximum or minimum value depending on whether the parameter is greater than the upper limit or smaller than the lower limit.

Query response {numeric}<newline><^END>

See also :CORR2:CKIT:STAN2:DC on page 244

Equivalent key sequence **[Setup View]** (Compensation kit setup display)

:CORR2:CKIT:STAN1:LIST

Syntax [:SENSe]:CORRection2:CKIT:STANdard1:LIST <numeric 1>,<numeric 2>,<numeric 3>
[:SENSe]:CORRection2:CKIT:STANdard1:LIST? <numeric 1>

Description Defines the equivalent parallel conductance (G) and equivalent parallel capacitance (Cp) values at a specified measurement point for the OPEN standard of the compensation kit.

If you have issued the **:CORR2:CKIT:LIST** command by specifying “OFF” to configure the instrument to accept fixed-value definitions for each standard of the user-defined calibration kit, specifying a particular measurement point has no effect; regardless of the measurement point number specified, the same value is applied to all measurement points. Similarly, when you issue this command in its query form, the command returns the same value regardless of the value you assign to a particular measurement number. Nevertheless, you must specify a valid measurement point number (for example, “1”) so that the command can successfully execute.

Parameters

	<numeric 1>	<numeric 2>	<numeric 3>
Description	Measurement point number	G	Cp
Range	1 to number of points (up to 32)	-1E6 to 1E6	-1E6 to 1E6
Default	1	0	0
Unit	None	S (siemens)	F (farad)
Resolution	1	1E-18	1E-18

If your specified parameter is beyond the valid range, the instrument ignores the parameter and uses either the maximum or minimum value depending on whether the parameter is greater than the upper limit or smaller than the lower limit.

Query response {numeric 2},{numeric 3}<newline><^END>

See also :CORR2:CKIT:LIST on page 241
:CORR2:CKIT:STAN2:LIST on page 245

Equivalent key sequence **[Setup View]** (Compensation kit setup display)

:CORR2:CKIT:STAN2:DC

Syntax [:SENSe]:CORRection2:CKIT:STANdard2:DC <numeric>
[:SENSe]:CORRection2:CKIT:STANdard2:DC?

Description Defines the dc resistance (R_{dc}) value of the SHORT standard of the compensation kit.

Parameters

	<numeric>
Description	R_{dc}
Range	-1E6 to 1E6
Default	0
Unit	Ω (ohm)
Resolution	1E-18

If your specified parameter is beyond the valid range, the instrument ignores the parameter and uses either the maximum or minimum value depending on whether the parameter is greater than the upper limit or smaller than the lower limit.

Query response {numeric}<newline><^END>

See also :CORR2:CKIT:STAN1:DC on page 242

Equivalent key sequence **[Setup View]** (Compensation kit setup display)

:CORR2:CKIT:STAN2:LIST

Syntax [:SENSe]:CORRection2:CKIT:STANdard2:LIST <numeric 1>,<numeric 2>,<numeric 3>
[:SENSe]:CORRection2:CKIT:STANdard2:LIST? <numeric 1>

Description Defines the equivalent series resistance (Rs) and equivalent series inductance (Ls) values at a specified measurement point, for the SHORT standard of the compensation kit.

If you have issued the **:CORR2:CKIT:LIST** command by specifying “OFF” to configure the instrument to accept fixed-value definitions for each standard of the user-defined calibration kit, specifying a particular measurement point has no effect; regardless of the measurement point number specified, the same value is applied to all measurement points. Similarly, when you issue this command in its query form, the command returns the same value regardless of the value you assign to a particular measurement number. Nevertheless, you must specify a valid measurement point number (for example, “1”) so that the command can successfully execute.

Parameters

	<numeric 1>	<numeric 2>	<numeric 3>
Description	Measurement point number	Rs	Ls
Range	1 to number of points (up to 32)	-1E6 to 1E6	-1E6 to 1E6
Default	1	0	0
Unit	None	Ω (ohm)	H (henry)
Resolution	1	1E-18	1E-18

If your specified parameter is beyond the valid range, the instrument ignores the parameter and uses either the maximum or minimum value depending on whether the parameter is greater than the upper limit or smaller than the lower limit.

Query response {numeric 2},{numeric 3}<newline><^END>

See also :CORR2:CKIT:LIST on page 241
:CORR2:CKIT:STAN1:LIST on page 243

Equivalent key sequence **[Setup View]** (Compensation kit setup display)

:CORR2:COLL

Syntax [:SENSe]:CORRection2:COLLect[:ACQuire] {STAN1|STAN2}

Description Obtains the data for calculating the compensation coefficients to use during impedance measurement and the compensation coefficients to use during R_{dc} measurement performed with the specified standard. The data is obtained for only the active table. This command is valid only when the calibration mechanism is on; otherwise, the command fails and an error is generated. (No query)

NOTE The measurement to obtain the data is not started by execution of this command. You must trigger the instrument after execution of this command when the trigger source is not set to internal trigger (Int).

Parameters

	Description
STAN1	OPEN standard
STAN2	SHORT standard

See also :CORR2:COLL:DC on page 247
:CORR2:COLL:RF on page 248

Equivalent key sequence [Cal/Compen] - **COMPEN DIALOG**

:CORR2:COLL:DC

Syntax [:SENSe]:CORRection2:COLLect[:ACQuire]:DC {STAN1|STAN2}
[:SENSe]:CORRection2:COLLect[:ACQuire]:DC?

Description Obtains the data for calculating the compensation coefficients to use during R_{dc} measurement performed with the specified standard. The data is obtained for only the active table. This command is valid only when the calibration mechanism is on; otherwise, the command fails and an error is generated. (No query)

NOTE The measurement to obtain the data is not started by execution of this command. You must trigger the instrument after execution of this command when the trigger source is not set to internal trigger (Int).

Parameters

	Description
STAN1	OPEN standard
STAN2	SHORT standard

See also :CORR2:COLL on page 246
:CORR2:COLL:RF on page 248

Equivalent key sequence **[Cal/Compen] - COMPEN DIALOG**

:CORR2:COLL:OPEN

Syntax [:SENSe]:CORRection2:COLLect:OPEN[:STATe] {ON|OFF|1|0}
[:SENSe]:CORRection2:COLLect:OPEN[:STATe]?

Description Turns on or off the OPEN compensation feature and calculates the compensation coefficients. This command is valid only after you have obtained the OPEN standard measurement data for calculating the compensation coefficients; otherwise, the command fails and an error is generated.

Parameters

	Description
ON or 1	Turns on the OPEN compensation feature
OFF or 0 (initial value)	Turns off the OPEN compensation feature

Query response {1|0}<newline><^END>

See also :CORR2:COLL:SAVE on page 249
:CORR2:COLL:SHOR on page 249

Equivalent key sequence [Cal/Compen] - **COMPEN STATUS - OPEN**

:CORR2:COLL:RF

Syntax [:SENSe]:CORRection2:COLLect[:ACQuire]:RF {STAN1|STAN2}
[:SENSe]:CORRection2:COLLect[:ACQuire]:RF?

Description Obtains the data for calculating the compensation coefficients to use during impedance measurement performed with the specified standard. The data is obtained for only the active table. This command is valid only when the calibration mechanism is on; otherwise, the command fails and an error is generated. (No query)

NOTE The measurement to obtain the data is not started by execution of this command. You must trigger the instrument after execution of this command when the trigger source is not set to internal trigger (Int).

Parameters

	Description
STAN1	OPEN standard
STAN2	SHORT standard

See also :CORR2:COLL on page 246
:CORR2:COLL:DC on page 247

Equivalent key sequence No equivalent keys are available on the front panel.

:CORR2:COLL:SAVE

Syntax [:SENSe]:CORRection2:COLLect:SAVE

Description Calculates the compensation coefficients and turns on the compensation mechanism. (No query)

If you are measuring only the OPEN standard, issuing this command turns on only the OPEN compensation feature. This is equivalent to issuing the **:CORR2:COLL:OPEN** command by specifying “ON.”

If you are measuring only the SHORT standard, issuing this command turns on only the SHORT compensation feature. This is equivalent to issuing the **:CORR2:COLL:SHOR** command by specifying “ON.”

If you are measuring both the OPEN and SHORT standards, issuing this command turns on both the OPEN and SHORT compensation features of the compensation mechanism. This is equivalent to issuing the **:CORR2:COLL:OPEN** and **:CORR2:COLL:SHOR** commands by specifying “ON.”

See also :CORR2:COLL on page 246
:CORR2:COLL:OPEN on page 248
:CORR2:COLL:SHOR on page 249

Equivalent key sequence [Cal/Compen] - COMPEN DIALOG

:CORR2:COLL:SHOR

Syntax [:SENSe]:CORRection2:COLLect:SHORT[:STATe] {ON|OFF|1|0}
[:SENSe]:CORRection2:COLLect:SHORT[:STATe]?

Description Turns on or off the SHORT compensation feature and calculates the compensation coefficients. This command is valid only after you have obtained the SHORT standard measurement data for calculating the compensation coefficients; otherwise, the command fails and an error is generated.

Parameters

	Description
ON or 1	Turns on the SHORT compensation feature
OFF or 0 (initial value)	Turns off the SHORT compensation feature

Query response {1|0}<newline><^END>

See also :CORR2:COLL:SAVE on page 249
:CORR2:COLL:OPEN on page 248

Equivalent key sequence [Cal/Compen] - COMPEN STATUS - SHORT

:CORR2:FIXT

Syntax [:SENSe]:CORRection2:FIXTure {NONE|FXT16191A|FXT16192A|FXT16193A|FXT16194A|FXT16196A|FXT16196B|FXT16196C|USER}
[:SENSe]:CORRection2:FIXTure?

Description Configures the instrument to use the specified test fixture connected to the test head.
To configure the instrument to use your custom test fixture, you must use the **:CORR2:FIXT:EDEL:DIST** command to compensate for the delay caused by the fixture connection.

Parameters

	Description
NONE (initial value)	Configures instrument to operate without a test fixture
FXT16191A	Configures instrument to use 16191A test fixture
FXT16192A	Configures instrument to use 16192A test fixture
FXT16193A	Configures instrument to use 16193A test fixture
FXT16194A	Configures instrument to use 16194A test fixture
FXT16196A	Configures instrument to use 16196A test fixture
FXT16196B	Configures instrument to use 16196B test fixture
FXT16196C	Configures instrument to use 16196C test fixture
USER	Configures instrument to use your custom test fixture

Query response {NONE|FXT16191A|FXT16192A|FXT16193A|FXT16194A|FXT16196A|FXT16196B|FXT16196C|USER}<newline><^END>

See also :CORR2:FIXT:EDEL:DIST on page 251
:CORR2:FIXT:LAB on page 252

Equivalent key sequence **[Cal/Compen] - SELECT FIXTURE - {None|16191A|16192A|16193A|16194A|16196A|16196B|16196C|USER}**

:CORR2:FIXT:EDEL:DIST

Syntax [:SENSe]:CORRection2:FIXTure:EDELay:DISTance <numeric>
[:SENSe]:CORRection2:FIXTure:EDELay:DISTance?

Description If you configure the instrument to use your custom test fixture connected to the test head, this command sets the electrical length that compensates for the delay caused by the connection of the custom test fixture.

Parameters

	<numeric>
Description	Electrical length to compensate for delay caused by fixture connection
Range	-1E6 to 1E6
Default	0
Unit	m (meter)
Resolution	1E-18

If your specified parameter is beyond the valid range, the instrument ignores the parameter and uses either the maximum or minimum value depending on whether the parameter is greater than the upper limit or smaller than the lower limit.

Query response {numeric}<newline><^END>

See also :CORR2:FIXT on page 250

Equivalent key sequence [**Cal/Compen**] - **SETUP USER FIXTURE - ELEC. LENGTH**

:CORR2:FIXT:LAB

Syntax [:SENSe]:CORRection2:FIXTure:LABel <string>
[:SENSe]:CORRection2:FIXTure:LABel?

Description Lets you specify the name of your custom test fixture.

Parameters

	<string>
Description	Name of custom test fixture
Range	Up to 8 characters
Default	“USER”

If you specified the name exceeds the maximum allowable length, the name is truncated to the maximum length.

Query response {string}<newline><^END>

See also :CORR2:FIXT on page 250

Equivalent key sequence **[Cal/Compen] - SETUP USER FIXTURE - LABEL KIT**

:DATA:CAD{1-8}?

Syntax :DATA[:DATA]:CAD {1|2|3|4|5|6|7|8}?

Description Returns a calibration data array (an array of measurement data obtained for calculating the calibration coefficients; see “Calibration Data Arrays” on page 80). The instrument holds eight calibration data arrays that correspond to two measurement passes for each of the OPEN, SHORT, LOAD, and LOW LOSS CAPACITOR standards. To obtain a particular array, suffix the command with the number that corresponds to the desired array. The following table lists the command suffix numbers associated with each array: (Query only)

- 1: Array that corresponds to first measurement pass for the OPEN standard
- 2: Array that corresponds to first measurement pass for the SHORT standard
- 3: Array that corresponds to first measurement pass for the LOAD standard
- 4: Array that corresponds to first measurement pass for the LOW LOSS CAPACITOR standard
- 5: Array that corresponds to second measurement pass for the OPEN standard
- 6: Array that corresponds to second measurement pass for the SHORT standard
- 7: Array that corresponds to second measurement pass for the LOAD standard
- 8: Array that corresponds to second measurement pass for the LOW LOSS CAPACITOR standard

Query response {numeric 1},..., {numeric N×2}<newline><^END>

	Description
{numeric n×2-1}	Real part of measurement data (complex number) obtained at nth point
{numeric n×2}	Imaginary part of measurement data (complex number) obtained at nth point

The command returns the real and imaginary parts of the measurement data (complex number) obtained at each measurement point. Therefore, the number of returned values is equal to N×2, where N represents the number of points defined in the active table while n represents an integer between 1 and N.

Equivalent key sequence No equivalent keys are available on the front panel.

:DATA:CCO{1-6}

Syntax :DATA[:DATA]:CCO{1|2|3|4|5|6} <numeric 1>,...,<numeric N×2>
 :DATA[:DATA]:CCO{1|2|3|4|5|6}?

where N represents the number of points defined in the active table.

Description Sets or returns a calibration coefficient array (see “Calibration Coefficient Arrays” on page 80). The instrument holds six calibration coefficient arrays that correspond to coefficients: A1, B1, C1, A2, B2, and C2. To obtain a particular array, suffix the command with the number that corresponds to the desired array. The following table lists the command suffix numbers associated with each array:

- 1: Array that corresponds to calibration coefficient A1
- 2: Array that corresponds to calibration coefficient B1
- 3: Array that corresponds to calibration coefficient C1
- 4: Array that corresponds to calibration coefficient A2
- 5: Array that corresponds to calibration coefficient B2
- 6: Array that corresponds to calibration coefficient C2

Parameters

	Description
<numeric n×2-1>	Real part of calibration coefficient (complex number) at nth point
<numeric n×2>	Imaginary part of calibration coefficient (complex number) at nth point

You must break down the calibration coefficient (complex number) at each measurement point into the real and imaginary parts so that the command receives N×2 parameters in all, where n represents an integer between 1 and N.

Query response {numeric 1},...,{numeric N×2}<newline><^END>

Equivalent key sequence No equivalent keys are available on the front panel.

:DATA:CMD{1-2}?

Syntax :DATA[:DATA]:CMD{1|2}?

Description Returns a compensation data array (an array of measurement data obtained for calculating the compensation coefficients; see “Compensation Data Arrays” on page 81). The instrument holds two compensation data arrays that correspond to the OPEN and SHORT standards. To obtain a particular array, suffix the command with the number that corresponds to the desired array. The following table lists the command suffix numbers associated with each array: (Query only)

- 1: Array that corresponds to measurement data for the OPEN standard
- 2: Array that corresponds to measurement data for the SHORT standard

Query response {numeric 1},..., {numeric N×2}<newline><^END>

	Description
{numeric n×2-1}	Real part of measurement data (complex number) obtained at nth point
{numeric n×2}	Imaginary part of measurement data (complex number) obtained at nth point

The command returns the real and imaginary parts of the measurement data (complex number) obtained at each measurement point. Therefore, the number of returned values is equal to N×2, where N represents the number of points defined in the active table while n represents an integer between 1 and N.

Equivalent key sequence No equivalent keys are available on the front panel.

:DATA:CMP{1-3}

:DATA:CMP{1-3}

Syntax :DATA[:DATA]:CMP{1|2|3} <numeric 1>,...,<numeric N×2>
 :DATA[:DATA]:CMP{1|2|3}?

where N represents the number of points defined in the active table.

Description Sets or returns a compensation coefficient array (see “Compensation Coefficient Arrays” on page 81). The instrument holds three compensation coefficient arrays that correspond to coefficients: A, B, and C. To obtain a particular array, suffix the command with the number that corresponds to the desired array. The following table lists the command suffix numbers associated each respective array:

- 1: Array that corresponds to compensation coefficient A
- 2: Array that corresponds to compensation coefficient B
- 3: Array that corresponds to compensation coefficient C

Parameters

	Description
<numeric n×2-1>	Real part of compensation coefficient (complex number) at nth point
<numeric n×2>	Imaginary part of compensation coefficient (complex number) at nth point

You must break down the compensation coefficient (complex number) at each measurement point into the real and imaginary parts so that the command receives N×2 parameters in all, where n represents an integer between 1 and N.

Query response {numeric 1},...,{numeric N×2}<newline><^END>

Equivalent key sequence No equivalent keys are available on the front panel.

:DATA:FDAT{1-4}?

Syntax	:DATA[:DATA]:FDATa{1 2 3 4}?
Description	Returns the display data array for one of parameters 1 (:FDAT1) through 4 (:FDAT4). This array contains the display data obtained by performing measurement parameter conversion and data operations on the corresponding data array (see “Display Data Arrays” on page 79). If the measurement fails because of overload, the command returns 9.9E37. (Query only)
Query response	For single-point measurement {numeric}<newline><^END> The command returns the value (real number) of the measured point. For list measurement {numeric 1},..., {numeric N}<newline><^END> The command returns as many values (real numbers) as the measurement points defined in the active table, in the order of measurement point numbers.
Equivalent key sequence	No equivalent keys are available on the front panel.

:DATA:IMON?

Syntax	:DATA[:DATA]:IMON?
Description	Returns the result of monitoring the current level of the test signal. If the measurement failed because of overload, the command returns 9.9E37. (Query only)
Query response	For single-point measurement {numeric}<newline><^END> The command returns the monitored value (real number) of the measured point. For list measurement {numeric 1},..., {numeric N}<newline><^END> The command returns the monitored value (real number) at each point defined in the active table. Therefore, the returned data contains as many monitored values as the number of measurement points (N) and is sent in the order of measurement point numbers.
See also	:DATA:VMON? on page 261
Equivalent key sequence	No equivalent keys are available on the front panel.

:DATA:RAW?

:DATA:RAW?

Syntax :DATA[:DATA]:RAW?

Description Returns the measurement data array, which contains complex-number data obtained by calibrating raw measurement data (see “Data Array” on page 79). (Query only)

Query response **For single-point measurement**

{numeric 1}, {numeric 2}<newline><^END>

The command returns the real and imaginary parts of the data of the measured point.

For list measurement

{numeric 1}, ..., {numeric N×2}<newline><^END>

	Description
{numeric n×2-1}	Real part of data at nth point
{numeric n×2}	Imaginary part of data at nth point

The command returns the real and imaginary parts of the data at each measurement point. Thus the number of returned values is equal to N×2, where N represents the number of points defined in the active table while n represents an integer between 1 and N.

Equivalent key sequence No equivalent keys are available on the front panel.

:DATA:RCAD{1-3}?

Syntax :DATA[:DATA]:RCAD{1|2|3}?

Description Returns a set of measurement data (real number) for calculating the calibration coefficients to use during R_{dc} measurement. The instrument holds three sets of calculation data, which are obtained by measuring the OPEN, SHORT, and LOAD standards. To obtain a particular data set, suffix the command with the number that corresponds to the desired data set. The following table lists the command suffix numbers associated with each data set: (Query only)

- 1: OPEN measurement data
- 2: SHORT measurement data
- 3: LOAD measurement data

Query response {numeric}<newline><^END>

Equivalent key sequence No equivalent keys are available on the front panel.

:DATA:RCCO{1-3}

Syntax :DATA[:DATA]:RCCO{1|2|3} <numeric>
 :DATA[:DATA]:RCCO{1|2|3}?

Description Sets or returns a calibration coefficient for R_{dc} measurement (see “Calibration coefficients and calibration data for R_{dc} measurement” on page 83). To set or obtain a particular coefficient, suffix the command with the number that corresponds to the desired coefficient. The following table lists the command suffix numbers associated with each coefficient:

- 1: Calibration coefficient A for R_{dc} measurement
- 2: Calibration coefficient B for R_{dc} measurement
- 3: Calibration coefficient C for R_{dc} measurement

Parameters

	Description
<numeric>	Calibration coefficient (real number) for R_{dc} measurement

Query response {numeric}<newline><^END>

Equivalent key sequence No equivalent keys are available on the front panel.

:DATA:RCMD{1-2}?

Syntax :DATA[:DATA]:RCMD{1|2}?

Description Returns a set of measurement data (real number) for calculating the compensation coefficients to use during R_{dc} measurement. The instrument holds two sets of calculation data, which are obtained by measuring the OPEN and SHORT standards. To obtain a particular data set, suffix the command with the number that corresponds to the desired data set. The following table lists the command suffix numbers associated with the respective data set: (Query only)

- 1: OPEN measurement data
- 2: SHORT measurement data

Query response {numeric}<newline><^END>

Equivalent key sequence No equivalent keys are available on the front panel.

:DATA:RCMP{1-3}

Syntax :DATA[:DATA]:RCMP{1|2|3} <numeric>
:DATA[:DATA]:RCMP{1|2|3}?

Description Sets or returns a compensation coefficient for R_{dc} measurement (see “Rdc compensation coefficients and compensation data” on page 84). To set or obtain a particular coefficient, suffix the command with the number that corresponds to the desired coefficient. The following table lists the command suffix numbers associated with each coefficient:

- 1: Compensation coefficient A for R_{dc} measurement
- 2: Compensation coefficient B for R_{dc} measurement
- 3: Compensation coefficient C for R_{dc} measurement

Parameters

	Description
<numeric>	Compensation coefficient (real number) for R_{dc} measurement

Query response {numeric}<newline><^END>

Equivalent key sequence No equivalent keys are available on the front panel.

:DATA:RDC?

Syntax	:DATA[:DATA]:RDC?
Description	Returns the result of R_{dc} measurement. (Query only)
Query response	{numeric}<newline><^END> If the R_{dc} measurement feature is disabled, the command fails and an error is generated.
Equivalent key sequence	No equivalent keys are available on the front panel.

:DATA:VMON?

Syntax	:DATA[:DATA]:VMON?
Description	Returns the result of monitoring the voltage level of the test signal. If the measurement fails because of overload, the command returns 9.9E37. (Query only)
Query response	For single-point measurement {numeric}<newline><^END> The command returns the monitored value (real number) of the measured point. For list measurement {numeric 1},..., {numeric N}<newline><^END> The command returns the monitored value (real number) at each point defined in the active table. Therefore, the returned data contains as many monitored values as the number of measurement points (N) and is sent in the order of measurement point numbers.
See also	:DATA:IMON? on page 257
Equivalent key sequence	No equivalent keys are available on the front panel.

:DISP

:DISP

Syntax :DISPlay[:WINDow][:STATe] {ON|OFF|1|0}
 :DISPlay[:WINDow][:STATe]?

Description Turns on or off the screen display of all of the measurement results, softkey labels, and instrument status information.

Parameters

	Description
ON or 1 (initial value)	Turns on screen display.
OFF or 0	Turns off screen display.

Query response {1|0}<newline><^END>

Equivalent key sequence **[Display] - DISPLAY**

:DISP:BACK

Syntax :DISPlay:BACKlight {ON|OFF|1|0}
 :DISPlay:BACKlight?

Description Turns on or off the backlight of the LCD screen. If the backlight is off, you cannot read information displayed on the screen.

Parameters

	Description
ON or 1 (initial value)	Turns on backlight.
OFF or 0	Turns off backlight.

Query response {1|0}<newline><^END>

Equivalent key sequence **[System] - SERVICE MENU - BACK LIGHT**

:DISP:CCL

- Syntax** :DISPlay:CClear
- Description** Clears the error message displayed in the title display area (at the topmost of the screen). (No query)
- Corresponding key** No front panel key is available to execute this function.

:DISP:TEXT1

- Syntax** :DISPlay[:WINDow]:TEXT1[:STATe] {ON|OFF|1|0}
 :DISPlay[:WINDow]:TEXT1[:STATe]?
- Description** Turns on or off the screen display of the measurement results (results of measurement parameters 1 to 4, results of test signal current/voltage level, and R_{dc} measurement results).

Parameters

	Description
ON or 1 (initial value)	Turns on screen display
OFF or 0	Turns off screen display

- Query response** {1|0}<newline><^END>
- Equivalent key sequence** **[Display] - SETUP MEAS DISP - DISPLAY**

:DISP:TEXT1:CALC{1-4}

Syntax :DISPlay[:WINDow]:TEXT1:CALCulate{1|2|3|4}[:STATe] {ON|OFF|1|0}
 :DISPlay[:WINDow]:TEXT1:CALCulate{1|2|3|4}[:STATe]?

Description Turns on or off the screen display of the measurement results for each of the parameters 1 (:CALC1) through 4 (:CALC4).

Parameters

	Description
ON or 1 (initial value)	Turns on screen display
OFF or 0	Turns off screen display

Query response {1|0}<newline><^END>

Equivalent key sequence **[Display] - SETUP MEAS DISP - {PRMTR-1|PRMTR-2|PRMTR-3|PRMTR-4} - DISPLAY**

:DISP:TEXT1:CALC{1-4}:DIG

Syntax :DISPlay[:WINDow]:TEXT1:CALCulate{1|2|3|4}:DIGit <numeric>
 :DISPlay[:WINDow]:TEXT1:CALCulate{1|2|3|4}:DIGit?

Description Specifies the number of digits to use in the screen display of the measurement result for each of the parameters 1 (:CALC1) through 4 (:CALC4).

Parameters

	<numeric>
Description	Number of digits
Range	4 to 6
Default	4
Resolution	1

If your specified parameter is beyond the valid range, the instrument ignores the parameter and uses either the maximum or minimum value depending on whether the parameter is greater than the upper limit or smaller than the lower limit.

Query response {numeric}<newline><^END>

Equivalent key sequence **[Display] - SETUP MEAS DISP - {PRMTR-1|PRMTR-2|PRMTR-3|PRMTR-4} - DIGIT**

:DISP:TEXT1:CALC{1-4}:FIX

Syntax
:DISPlay[:WINDow]:TEXT1:CALCulate{1|2|3|4}:FIX {ON|OFF|1|0}
:DISPlay[:WINDow]:TEXT1:CALCulate{1|2|3|4}:FIX?

Description
Specifies whether to fix the decimal point in the screen display of the measurement result for each of parameters 1 (:CALC1) through 4 (:CALC4).

Parameters

	Description
ON or 1	Instructs instrument to fix the decimal point
OFF or 0 (initial value)	Instructs instrument NOT to fix the decimal point

Query response
{1|0}<newline><^END>

Equivalent key sequence
[Display] - SETUP MEAS DISP - {PRMTR-1|PRMTR-2|PRMTR-3|PRMTR-4} - MSD FIXED

:DISP:TEXT1:CALC{1-4}:MSD

Syntax
:DISPlay[:WINDow]:TEXT1:CALCulate{1|2|3|4}:MSD <numeric>
:DISPlay[:WINDow]:TEXT1:CALCulate{1|2|3|4}:MSD?

Description
When the instrument is configured to fix the decimal point in the screen display of the measurement result for each of the parameters 1 (:CALC1) through 4 (:CALC4), use this command to set the most significant digit. You can specify the most significant digit by its exponent. For example, to set the most significant digit to 100n (1E-7), specify -7 as the parameter value.

Parameters

	<numeric>
Description	Exponent that indicates the most significant digit
Range	-15 to 15
Default	0
Resolution	1

If your specified parameter is beyond the valid range, the instrument ignores the parameter and uses either the maximum or minimum value depending on whether the parameter is greater than the upper limit or smaller than the lower limit.

Query response
{numeric}<newline><^END>

Equivalent key sequence
[Display] - SETUP MEAS DISP - {PRMTR-1|PRMTR-2|PRMTR-3|PRMTR-4} - MODIFY MSD

:DISP:TEXT1:CALC{11-12}

Syntax :DISPlay[:WINDow]:TEXT1:CALCulate{11|12}[:STATe] {ON|OFF|1|0}
:DISPlay[:WINDow]:TEXT1:CALCulate{11|12}[:STATe]?

Description Turns on or off the screen display of the results of monitoring the test signal current level (:CALC11) or voltage level (:CALC12).

Parameters

	Description
ON or 1 (initial value)	Turns on screen display
OFF or 0	Turns off screen display

Query response {1|0}<newline><^END>

Equivalent key sequence **[Display] - SETUP MEAS DISP - {I-mon|V-mon} - DISPLAY**

:DISP:TEXT1:CALC{11-12}:DIG

Syntax :DISPlay[:WINDow]:TEXT1:CALCulate{11|12}:DIGit <numeric>
:DISPlay[:WINDow]:TEXT1:CALCulate{11|12}:DIGit?

Description Specifies the number of digits to use in the screen display of the results of monitoring the test signal current level (:CALC11) or voltage level (:CALC12).

Parameters

	<numeric>
Description	Number of digits
Range	4 to 6
Default	4
Resolution	1

If your specified parameter is beyond the valid range, the instrument ignores the parameter and uses either the maximum or minimum value depending on whether the parameter is greater than the upper limit or smaller than the lower limit.

Query response {numeric}<newline><^END>

Equivalent key sequence **[Display] - SETUP MEAS DISP - {I-mon|V-mon} - DIGIT**

:DISP:TEXT1:CALC{11-12}:FIX

Syntax :DISPlay[:WINDow]:TEXT1:CALCulate{11|12}:FIX {ON|OFF|1|0}
 :DISPlay[:WINDow]:TEXT1:CALCulate{11|12}:FIX?

Description Specifies whether to fix the decimal point in the screen display of the results of monitoring the test signal current level (:CALC11) or voltage level (:CALC12).

Parameters

	Description
ON or 1	Instructs instrument to fix the decimal point
OFF or 0 (initial value)	Instructs instrument NOT to fix the decimal point

Query response {1|0}<newline><<^END>

Equivalent key sequence **[Display] - SETUP MEAS DISP - {I-mon|V-mon} - MSD FIXED**

:DISP:TEXT1:CALC{11-12}:MSD

Syntax :DISPlay[:WINDow]:TEXT1:CALCulate{11|12}:MSD <numeric>
 :DISPlay[:WINDow]:TEXT1:CALCulate{11|12}:MSD?

Description When the instrument is configured to fix the decimal point in the screen display of the results of monitoring the test signal current level (:CALC11) or voltage level (:CALC12), use this command to set the most significant digit. You can specify the most significant digit by its exponent. For example, to set the most significant digit to 0.01 (1E-2), specify -2 as the parameter value.

Parameters

	<numeric>
Description	Exponent that indicates the most significant digit
Range	-15 to 15
Default	0
Resolution	1

If your specified parameter is beyond the valid range, the instrument ignores the parameter and uses either the maximum or minimum value depending on whether the parameter is greater than the upper limit or smaller than the lower limit.

Query response {numeric}<newline><<^END>

Equivalent key sequence **[Display] - SETUP MEAS DISP - {I-mon|V-mon} - MODIFY MSD**

:DISP:TEXT1:CALC13:DIG

Syntax :DISPlay[:WINDow]:TEXT1:CALCulate13:DIGit <numeric>
:DISPlay[:WINDow]:TEXT1:CALCulate13:DIGit?

Description Specifies the number of digits to use in the screen display of the results of R_{dc} measurement.

Parameters

	<numeric>
Description	Number of digits
Range	4 to 6
Default	4
Resolution	1

If your specified parameter is beyond the valid range, the instrument ignores the parameter and uses either the maximum or minimum value depending on whether the parameter is greater than the upper limit or smaller than the lower limit.

Query response {numeric}<newline><^END>

Equivalent key sequence **[Display] - SETUP MEAS DISP - R_dc - DIGIT**

:DISP:TEXT1:CALC13:FIX

Syntax :DISPlay[:WINDow][:TEXT1]:CALCulate13:FIX {ON|OFF|1|0}
:DISPlay[:WINDow][:TEXT1]:CALCulate13:FIX?

Description Specifies whether to fix the decimal point in the screen display of the results of R_{dc} measurement.

Parameters

	Description
ON or 1	Instructs instrument to fix the decimal point
OFF or 0 (initial value)	Instructs instrument NOT to fix the decimal point

Query response {1|0}<newline><^END>

Equivalent key sequence **[Display] - SETUP MEAS DISP - R_dc - MSD FIXED**

:DISP:TEXT1:CALC13:MSD

Syntax :DISPlay[:WINDow]:TEXT1:CALCulate13:MSD <numeric>
:DISPlay[:WINDow]:TEXT1:CALCulate13:MSD?

Description When the instrument is configured to fix the decimal point in the screen display of the results of R_{dc} measurement, use this command to set the most significant digit. You can specify the most significant digit by its exponent. For example, to set the most significant digit to 100 (1E2), specify 2 as the parameter value.

Parameters

	<numeric>
Description	Exponent that indicates the most significant digit
Range	-15 to 15
Default	0
Resolution	1

If your specified parameter is beyond the valid range, the instrument ignores the parameter and uses either the maximum or minimum value depending on whether the parameter is greater than the upper limit or smaller than the lower limit.

Query response {numeric}<newline><^END>

Equivalent key sequence **[Display] - SETUP MEAS DISP - R_dc - MODIFY MSD**

:DISP:TEXT10

:DISP:TEXT10

Syntax :DISPlay[:WINDow]:TEXT10[:STATe] {ON|OFF|1|0}
 :DISPlay[:WINDow]:TEXT10[:STATe]?

Description Specifies whether to display the title (defined with the **:DISP:TEXT10:DATA** command) in the title display area (uppermost part of the screen).

Parameters

	Description
ON or 1 (initial value)	Shows title
OFF or 0	Hides title

Query response {1|0}<newline><^END>

See also :DISP:TEXT10:DATA on page 270

Equivalent key sequence **[Display] - TITLE MENU - DISPLAY**

:DISP:TEXT10:DATA

Syntax :DISPlay[:WINDow]:TEXT10:DATA <string>
 :DISPlay[:WINDow]:TEXT10:DATA?

Description Defines the string to display in the title display area.

Parameters

	<string>
Description	String displayed in the title display area
Range (maximum length)	Up to 90 characters
Default	Blank (“”)

If your specified title exceeds the maximum allowable length, the title is truncated to the maximum length.

Query response {string}<newline><^END>

See also :DISP:TEXT10 on page 270

Equivalent key sequence **[Display] - TITLE MENU - MODIFY TITLE**

:DISP:TEXT11

Syntax :DISPlay[:WINDow]:TEXT11[:STATe] {ON|OFF|1|0}
 :DISPlay[:WINDow]:TEXT11[:STATe]?

Description Specifies whether to display the date and time at the right-hand side of the status display area (lower-right part of the LCD screen).

Parameters

	Description
ON or 1	Shows date and time
OFF or 0 (initial value)	Hides date and time

Query response {1|0}<newline><^END>

See also :DISP:TEXT11:MODE on page 271

Equivalent key sequence **[Display] - DATE & TIME**

:DISP:TEXT11:MODE

Syntax :DISPlay[:WINDow]:TEXT11:MODE {STAMp|LIVE}
 :DISPlay[:WINDow]:TEXT11:MODE?

Description Specifies whether to update the date and time displayed at the right-hand side of the status display area.

Parameters

	Description
STAMp (initial value)	Does NOT update date and time
LIVE	Updates date and time

Query response {STAM|LIVE}<newline><^END>

See also :DISP:TEXT11 on page 271

Equivalent key sequence **[Display] - DATE & TIME**

:DISP:TEXT2:LAB{1-4}

Syntax :DISPlay[:WINDow]:TEXT2:LABel{1|2|3|4} {PARam1|PARam2|PARam3|PARam4|VMONitor|IMONitor|FREQuency|AVERage|POWer|RDC}

Description Defines each of the four display items (:LAB1 through :LAB4) that appear on the list measurement screen.

Parameters

	Description
PARam1	Displays parameter 1 measurement result
PARam2	Displays parameter 2 measurement result
PARam3	Displays parameter 3 measurement result
PARam4	Displays parameter 4 measurement result
VMONitor	Displays result of monitoring the test signal voltage level
IMONitor	Displays result of monitoring the test signal current level
FREQuency	Displays frequency setting of the test signal
AVERage	Displays averaging factor setting
POWer	Displays test signal level setting
RDC	Displays result of R_{dc} measurement

Display item 1 defaults to PARam1; display item 2 defaults to PARam2; display item 3 defaults to PARam3; display item 4 defaults to PARam4.

Query response {PAR1|PAR2|PAR3|PAR4|VMON|IMON|FREQ|AVER|POW|RDC}<newline><^END>

See also :SOUR:LIST:STAT on page 291

Equivalent key sequence [Prmtr] - SETUP LIST PRMTRS - {LABEL-1|LABEL-2|LABEL-3|LABEL-4} - {PRMTR-1|PRMTR-2|PRMTR-3|PRMTR-4|V-mon|I-mon|FREQ|AVG|POWER|R_dc}

:DISP:UPD

Format :DISPlay:UPDate {ON|OFF|1|0}
:DISPlay:UPDate?

Description Sets update of the LCD to On or OFF.

When update is set to ON, all displayed items are updated according to changes in measurement values, instrument settings, instrument status, and so on.

When update is set to OFF, only the measurement results (measurement results from measurement parameters 1-4, monitoring results of current and voltage of the measurement signals, R_{dc} measurement results, results of comparator) that are displayed at the execution of the command are updated (the latest results are displayed after each measurement). On the other hand, the measurement results not displayed at the execution of the command, the contents of the instrument status display area, and instrument setting display are not necessarily updated. For example, if update of the LCD is set to OFF when R_{dc} measurement is set to off, R_{dc} measurement results will not be displayed even if you subsequently turn on R_{dc} measurement.

Parameter

	Description
ON or 1 (initial value)	Sets update to ON
OFF or 0	Sets update to OFF

Query response {1|0}<newline><^END>

Equivalent key sequence **[System] - SERVICE MENU - UPDATE DISPLAY**

:FETC?

Syntax	:FETCh?
Description	Returns the measurement data from the most recently performed measurement. (Query only)
Query response	<p>For single-point measurement</p> <pre>{stat},{par1},{par2},{par3},{par4},{Imon},{Vmon},{Rdc},{comp}<newline><<^END></pre> <p>The command returns the following data at the measured point.</p> <p>{stat}: Measurement status, which is represented as an integer between 0 and 3 as follows:</p> <ul style="list-style-type: none"> 0: No error 1: Detection of measurement failure (overload) 2: Detection of R_{dc} out of range 3: Simultaneous detection of overload and R_{dc} out of range <p>{par1}: Parameter 1 measurement result</p> <p>{par2}: Parameter 2 measurement result</p> <p>{par3}: Parameter 3 measurement result</p> <p>{par4}: Parameter 4 measurement result</p> <p>{Imon}: Result of monitoring test signal current level</p> <p>{Vmon}: Result of monitoring test signal voltage level</p> <p>{Rdc}: Result of R_{dc} measurement.</p> <p>{comp}: Bin sort result, which can be an integer between 0 and 14 as follows:</p> <ul style="list-style-type: none"> 0: Indicates a DUT that was not sorted into any of bins 1 through 13 1: Sorted into bin 1 2: Sorted into bin 2 3: Sorted into bin 3 4: Sorted into bin 4 5: Sorted into bin 5 6: Sorted into bin 6 7: Sorted into bin 7 8: Sorted into bin 8 9: Sorted into bin 9 10: Sorted into bin 10 11: Sorted into bin 11 12: Sorted into bin 12 13: Sorted into bin 13 14: Sort failed

NOTE

The result of parameter 1 is not returned if the display of parameter 1 is off. The results of parameters 2 through 4 as well as the test signal current/voltage levels are treated in a similar way.

The result of R_{dc} measurement is not returned if the R_{dc} measurement feature is off.

The bin sort result is not returned if the comparator is off.

NOTE

If the measurement failed because of overload (that is, the measurement status is 1 or 3), the command returns 9.9E37 for the measurement results of parameters 1 through 4, the test signal monitor results, and the R_{dc} measurement result; the command returns 14 for the comparator result.

For list measurement

```
{stat 1},{par1 1},{par2 1},{par3 1},{par4 1},{Imon 1},{Vmon 1},{Rdc 1},...,
{stat N},{par1 N},{par2 N},{par3 N},{par4 N},{Imon N},{Vmon N},{Rdc N},
{comp}<newline><^END>
```

where N represents the number of points defined in the active table while n represents an integer between 1 and N.

The command returns data at all measurement points in the active table. The returned data consists of the following items:

- {stat n}: Measurement status at measurement point number n
- {par1 n}: Parameter 1 measurement result at measurement point number n
- {par2 n}: Parameter 2 measurement result at measurement point number n
- {par3 n}: Parameter 3 measurement result at measurement point number n
- {par4 n}: Parameter 4 measurement result at measurement point number n
- {Imon n}: Result of monitoring test signal current level at measurement point number n
- {Vmon n}: Result of monitoring test signal voltage level at measurement point number n
- {Rdc n}: Result of R_{dc} measurement
- {comp}: Bin sort result

NOTE

The result of R_{dc} measurement is returned N times. However, all of the results of R_{dc} measurement have the same value because R_{dc} is measured only once.

The bin sort result is finally returned only once.

See also

- :SOUR:LIST:STAT on page 291
- :DISP:TEXT1:CALC{1-4} on page 264
- :DISP:TEXT1:CALC{11-12} on page 266
- :SOUR:LIST:RDC on page 290
- :CALC:COMP on page 205
- :READ? on page 287
- *TRG on page 202

Equivalent key sequence

No equivalent keys are available on the front panel.

:FORM

Format :FORMat[:DATA] {ASCii|REAL}
:FORMat[:DATA]?

Description Specifies the format used for data transfer with the following commands.

- :FETC? on page 274
- :READ? on page 287
- *TRG on page 202
- Commands that begin with **:DATA**

For details on the data transfer format, see “Data Transfer Format” on page 74.

Parameter

	Description
ASCii (initial value)	Specifies ASCII format
REAL	Specifies binary format

Query response {ASC|REAL}<newline><^END>

See also :FORM:BORD on page 277
*RST on page 200

Equivalent key sequence No equivalent keys are available on the front panel.

:FORM:BORD

Format :FORMat:BORDer {NORMal|SWAPped}
 :FORMat:BORDer?

Description Specifies the order for transferring each byte comprising 8-byte data if the binary format is selected as the data transfer format. For details on the data transfer format, see “Data Transfer Format” on page 74.

Parameter

	Description
NORMal (initial value)	Specifies byte order so that data transfer begins at the byte containing MSB (Most Significant Bit).
SWAPped	Specifies byte order so that data transfer begins at the byte containing LSB (Least Significant Bit).

Query response {NORM|SWAP}<newline><^END>

Related command :FORM on page 276

Equivalent key sequence No equivalent keys are available on the front panel.

:HCOP

:HCOP

Syntax :HCOPy[:IMMediate]

Description Outputs the data selected with the **:HCOP:CONT** command to the printer connected to the 4287A. (No query)

See also :HCOP:CONT on page 278

Equivalent key sequence **[Display] - PRINT MENU - PRINT**

:HCOP:ABOR

Syntax :HCOPy:ABORt

Description Aborts print operation. (No query)

Equivalent key sequence **[Display] - PRINT MENU - ABORT PRINTING**

:HCOP:CONT

Syntax :HCOPy:CONTent {SCReen|SETup|LIST}
:HCOPy:CONTent?

Description Lets you select what to print.

Parameters

	Description
SCReen (initial value)	Instructs the bitmap images*1 from the non-volatile memory (clipboard). If no image resides on the clipboard, the image currently displayed on screen is transferred to the clipboard before it is output to the printer. When you are working with the measurement results for single-point measurement, you can choose this item to output the data as an image.
SETup	Instructs the instrument to output the active table contents, which can contain a measurement point setup table, calibration kit setup table, compensation kit setup table, and BIN sorting setup table.
LIST	Instructs the instrument to output the measurement results of list measurement across all of the measurement points. You cannot output this data when you are working with the results of single-point measurement.

*1. This is the image that is displayed before you press the **[Capture]** key (**[Display]** key).

Query response {SCR|SET|LIST}<newline><^END>

See also :HCOP on page 278

Equivalent key sequence **[Display] - PRINT MENU - CONTENT**

:HCOP:DPR

Syntax :HCOPy:DPRinter <numeric>
 :HCOPy:DPRinter?

Description Configures the 4287A to use the specified printer for print operations. You can use the **:HCOP:PRIN?** command to obtain a list of available (connected) printers and their numbers.

Parameters

	<number>
Description	Printer number
Range	1 to the maximum number returned by the :HCOP:PRIN? command
Default	1
Resolution	1

If your specified parameter is beyond the valid range, the instrument ignores the parameter and uses either the maximum or minimum value depending on whether the parameter is greater than the upper limit or smaller than the lower limit.

Query response {string}<newline><^END>

	Description
{string}	Printer name

NOTE The query response is different from the parameter used for setting.

See also :HCOP:PRIN? on page 280

Equivalent key sequence **[Display] - PRINT MENU - SELECT DEFAULT PRINTER**

:HCOP:IMAG

Syntax :HCOPy:IMAGe {NORMal|INVert|MONochrome}
:HCOPy:IMAGe?

Description If you have issued the **:HCOP:CONT** command by specifying “SCR” to configure the instrument to print out the LCD screen contents, use this command to select the print color scheme.

Parameters

	Description
NORMal (initial value)	Instructs instrument to output a color image using a color scheme that approximates that of the screen display.
INVert	Instructs instrument to output a color image using a color scheme that is inverse to that of the screen display.
MONochrome	Instructs instrument to output a monochrome image using a color scheme inverse that is to that of the screen display.

Query response {NORM|INV|MON}<newline><^END>

See also :HCOP:CONT on page 278

Equivalent key sequence **[Display] - PRINT MENU - IMAGE**

:HCOP:PRIN?

Syntax :HCOPy:PRINters?

Description Returns the total number of printers available with the 4287A as well as each printer's number and name. Note that when you use the **:HCOP:DPR** command to configure the instrument to use a specific printer, you will need to specify the appropriate printer number. (Query only)

Query response {string}<newline><^END>

The command returns a string in the following format.

“N<newline>,1,first printer name<newline>,...,N,Nth printer name<newline>”

where N represents the total number of printers.

See also :HCOP:DPR on page 279

Equivalent key sequence No equivalent keys are available on the front panel.

:INIT

Syntax :INITiate[:IMMEDIATE]

Description When the trigger system is in the idle state, issuing this command activates the trigger system. The trigger system returns to the idle state after completing one trigger cycle. When the trigger system is not in the idle state or configured to be continuously activated (i.e., after you have issued the **:INIT:CONT** command by specifying “ON”), issuing this command generates an error. For more information on the trigger system, see “Trigger system” on page 66. (No query)

See also :INIT:CONT on page 281

Equivalent key sequence No equivalent keys are available on the front panel.

:INIT:CONT

Syntax :INITiate:CONTinuous {ON|OFF|1|0}
:INITiate:CONTinuous?

Description Specifies whether to continuously activate the trigger system. This setting is initialized to OFF when the ***RST** is issued. For more information on the trigger system, see “Trigger system” on page 66.

Parameters

	Description
ON or 1 (initial value)	Instructs instrument to continuously activate trigger system
OFF or 0	Instructs instrument to NOT continuously activate trigger system

Query response {1|0}<newline><<^END>

See also *RST on page 200

Equivalent key sequence No equivalent keys are available on the front panel.

:MMEM:CAT?

Syntax	:MMEM:CATalog?
Description	<p>This command reads the following information about the storage device (except the floppy disk drive) built in the 4287A. (Query only)</p> <ul style="list-style-type: none">• Capacity used• Free (available) capacity• Names and sizes of files
Query response	<p>{used_size},{free_size},{name 1},{type 1},{size 1},..., {name N},{type N},{size N}<newline><^END></p> <p>N is the number of all files contained in the built-in storage.</p> <p>{used_size}: Already used capacity (bytes) of built-in storage</p> <p>{free_size}: Free capacity (bytes) of built-in storage</p> <p>{name n}: Name of the nth file (Character string enclosed within double quotation marks ("))</p> <p>{type n}: A pair of double quotation marks ("") are always read.</p> <p>{size n}: Size (bytes) of the nth file</p> <p>With n defined as integer 1 to N, N sets of {name n}, {type n}, and {size n} are read.</p>
Equivalent key sequence	No equivalent keys are available on the front panel.

:MMEM:COPY

Syntax :MMEM:COPY <string 1>,<string 2>

Description This command copies a file.

To specify the file, use a file name accompanying an extension. If you want to specify a file residing on the floppy disk, you must attach "A:" to the head of the file name. To use the directory and file names for specification, separate them using a slash (/).

If the specified source file is not found, an error will occur and the command will be ignored. Note that, if the file that has the same name as the specified source file already exists, it will be overwritten. (No query)

Parameters

	<string 1>	<string 2>
Description	Source file name	Destination file name
Range	Up to 248 characters (including extension)	Up to 248 characters (including extension)

Equivalent key sequence **[Save/Recall] - FILE UTILITY**

:MMEM:CRE:DIR

Syntax :MMEM:CREate:DIRectory <string>

Description This command creates a new directory (folder).

If you want a directory created on the floppy disk, you must attach "A:" to the head of the file name. If you want a file created under an existing directory, use a slash (/) to separate directory names.

If the file that has the same name as the specified source file already exists, an error will occur and the command will be ignored. (No query)

Parameters

	<string>
Description	Name of the directory to be created
Range	Up to 248 characters

Equivalent key sequence **[Save/Recall] - FILE UTILITY**

:MMEM:DEL

:MMEM:DEL

Syntax :MMEM:DELeTe <string>

Description This command deletes an existing file or directory (folder).
 If a directory is specified, all files and directories in it will be deleted.
 To specify a file, use a file name accompanying an extension. If you want to specify a file or directory on the floppy disk, you must add "A:" to the head of the file name. To specify a file (directory) under an existing directory, use a slash (/) to separate directory names or a directory and a file (or directory) name.
 If you specify "D:/USER" for the directory name, all user-created files and directories in the 4287A built-in storage will be deleted.
 If the specified file or directory is not found, an error will occur and the command will be ignored. (No query)

Parameters

	<string>
Description	Name of the directory to be deleted
Range	Up to 248 characters (including extension)

Equivalent key sequence **[Save/Recall] - FILE UTILITY**

:MMEM:LOAD

Syntax :MMEM:LOAD <string>

Description Recalls the instrument settings from an .sta file previously saved with the **:MMEM:STOR** command.
 You must specify the file name with the extension. When you specify a file on the floppy disk drive, precede the file name with "A:". When you specify a file under a directory, delimit the directory and file names with a slash (/).
 If your specified file is not found, the command fails and an error is generated. (No query)

Parameters

	<string>
Description	Name of file to recall
Range	Up to 248 characters (including extension)

Equivalent key sequence **[Save/Recall] - RECALL STATE**

:MMEM:STOR

Format :MMEM:STORe <String>[, {LOG|LIST|SETup|COMParator}]

Description Saves the instrument settings (including calibration/compensation), images on the LCD stored in the volatile memory (clipboard) (images of the LCD when the **[Capture]** key is pressed), measurement data for statistical analysis, list measurement results, or the contents of the setup table as a file. Contents to be saved depend on the extension of the file specified (first parameter). However, you should specify the second parameter only if the extension is “.csv”. The list below shows each extension and the corresponding contents to be saved. (No Query)

- | | |
|------|---|
| .sta | Instrument settings (binary format) |
| .bmp | Images on the LCD ^{*1} (bitmap format) |
| .csv | Comma-separated data for the following items (ASCII format) <ul style="list-style-type: none"> • Measurement data for statistical analysis^{*2} • List measurement results • Contents of setup table |
| .dta | Measurement data for statistical analysis ^{*2} (binary format) |

When specifying a file on the floppy disk drive, you must specify “A:” at the beginning of the filename. When specifying a directory name and filename, you must separate them with a slash (/).

If a filename you specify already exists, note that the existing file may be overwritten by the new file.

NOTE A file for instrument settings saved as autorec.sta is automatically recalled during power-on of the 4287A.

Parameter First parameter: <String>

	<String >
Description	Name of file to be saved
Range	Less than 248 characters (including extension)

*1. If no image exists on the clipboard, the images on the LCD are stored on the clipboard when the command is executed and then they are saved.

*2. In the ASCII format (extension “.csv”), up to 65,536 measurement data for statistical analysis can be saved. If the frequency of data measurement stored on the volatile memory exceeds 65,536, only the data of the first 65,536 measurements are saved and the remaining data are ignored. In the binary format (extension “.dta”), there is no limit to measurement frequency, and thus all of the stored measurement data for statistical analysis are saved.

:MMEM:STOR

Second parameter: {LOG|LIST|SETup|COMParator}

You should specify the second parameter only if the file extension is “.csv”. When this parameter is not specified for any file with the extension “.csv”, measurement data for statistical analysis (LOG) are saved.

	Description
LOG	Specifies that measurement data for statistical analysis are saved.
LIST	Specifies that measurement results of list measurement at all measurement points are saved. This parameter is not available for single-point measurement.
SETup	Specifies that contents of all measurement point setup tables, contents of all calibration kit setup tables, and contents of all compensation kit setup tables are saved.
COMParator	Specifies that contents of all BIN sorting setup tables are saved.

Equivalent key
sequence

**[Save/Recall] - {SAVE STATE|EXPORT LIST VIEW|EXPORT LOG DATA(ASC)|
EXPORT LOG DATA(BIN)|SAVE GRAPHIC}**

On the setup screen (**[Setup View]**) **[Alt] - [1] - [1]**

:READ?

Syntax :READ? [<numeric>]

Description When the instrument is configured to use an internal, manual or external trigger source (that is, after you have issued the **:TRIG:SOUR** command by specifying “INT”, “MAN” or “EXT”), issuing this command without the parameter sets the trigger system into trigger wait state. Then this command returns the measurement data when the instrument is triggered and has completed the measurement cycle.

When the instrument is configured to use an internal, manual or external trigger source, issuing this command with the parameter sets the active table to the number specified by the parameter. Then the 4287A is operated as described above. In other words, issuing this command with the parameter causes the same operation as when the **:SOUR:LIST:TABL** command is issued, and then the **:READ?** command is issued without the parameter.

When the instrument is configured to use the GPIB/LAN trigger source (that is, after you have issued the **:TRIG:SOUR** command by specifying “BUS”), this command fails and an error is generated. This is because issuing the command would prevent the instrument from being triggered. (Query only)

NOTE When the instrument is configured to use a manual or external trigger source, it does not accept any additional command until it is triggered from the external source. To exit from this state without triggering the instrument from the external source, you must send the Device Clear command (“CLEAR” statement in HP BASIC) to abort query processing.

Parameters This is an optional parameter. You don’t have to specify the parameter if you don’t intend to change the active table every measurement.

	<numeric>
Description	Table number
Range	1 to 8
Default	1
Resolution	1

If your specified parameter is beyond the valid range, the command fails and an error is generated.

Query response Same as the **:FETC?** command. See the description of **:FETC?**.

See also **:FETC?** on page 274
:TRIG:SOUR on page 304
:SOUR:LIST:TABL on page 291

Equivalent key sequence No equivalent keys are available on the front panel.

:SOUR:LIST

:SOUR:LIST

Syntax :SOURce:LIST <nop>,<freq 1>,<ave 1>,<pow 1>,...,<freq N>,<ave N>,<pow N>
:SOURce:LIST?

where N represents the number of points contained in the active table (this number is specified with the <nop> parameter).

Description Sets up the active table by specifying the measurement frequency values, averaging factors, and oscillator levels for all measurement points.

Parameters

	<nop>	<freq n>	<ave n>
Description	Number of measurement points (N)	Measurement frequency at nth point	Averaging factor at nth point
Range	1 to 32	1E6 to 3000E6	1 to 100
Default	1	1E6	1
Unit	_____	Hz	_____
Resolution	1	100E3	1

	<pow n>		
Description	Oscillator level at nth point		
Unit to apply to setting *1	dBm	mA	mV
Range	-40 to 1	0.1 to 10	5 to 502
Default	-13	2	100
Unit	dBm	mA	mV
Resolution	0.1 dB*2		

*1. Use the **:SOUR:UNIT** command to select the unit for the setting.

*2. The value is converted to dBm and then rounded off in resolutions of 0.1dB when mA or mV is selected as the unit of oscillator level.

where N represents an integer between 1 and N.

If your specified parameter is beyond the valid range, the instrument ignores the parameter and uses either the maximum or minimum value depending on whether the parameter is greater than the upper limit or smaller than the lower limit.

Query response {nop},{freq 1},{ave 1},{pow 1},...,{freq N},{ave N},{pow N}<newline><^END>

See also :SOUR:LIST:SIZE? on page 290
:SOUR:UNIT on page 292

Equivalent key sequence **[Setup View]** (Measurement point setup display)

:SOUR:LIST:CLE

Syntax	:SOURce:LIST:CLEar
Description	Resets all of the measurement point setup tables to the factory default settings, regardless of the active table settings. (No query)
Equivalent key sequence	[Alt] - [2] - [8] - [2] (when the measurement point setup display is selected by [Setup View])

:SOUR:LIST:POIN

Syntax	:SOURce:LIST:POINt <numeric> :SOURce:LIST:POINt?
Description	<p>Specifies the measurement point for single-point measurement. This setting is retained even if the active table is changed. If the specified point number exceeds the maximum point number allowed in the new active table, however, the instrument will perform single-point measurement using that maximum number instead of the previously specified number.</p> <p>This setting is reset when settings in the measurement point setup table are changed by execution of the :SOUR:LIST or :SOUR:LIST:CLE command.</p>

Parameters

	<numeric>
Description	Point number for single-point measurement
Range	1 to number of points (up to 32)
Default	1
Resolution	1

If your specified parameter is beyond the valid range, the instrument ignores the parameter and uses either the maximum or minimum value depending on whether the parameter is greater than the upper limit or smaller than the lower limit.

Query response	{numeric}<newline><^END>
See also	:SOUR:LIST on page 288 :SOUR:LIST:CLE on page 289 :SOUR:LIST:STAT on page 291
Equivalent key sequence	[Stml Select] - POINT No.

:SOUR:LIST:RDC

Syntax :SOURce:LIST:RDC {ON|OFF|1|0}
 :SOURce:LIST:RDC?

Description Specifies whether to perform R_{dc} measurement. This setting is retained even if the active table is changed.

Parameters

	Description
ON or 1	Instructs instrument to perform R_{dc} measurement (turns on R_{dc} measurement function)
OFF or 0 (initial value)	Instructs instrument to NOT perform R_{dc} measurement (turns off R_{dc} measurement function)

Query response {1|0}<newline><^END>

Equivalent key sequence **[Prmtr] - RDC MEAS**

:SOUR:LIST:RDC:OFSC

Syntax :SOURce:LIST:RDC:OFSCancel {ON|OFF|1|0}
 :SOURce:LIST:RDC:OFSCancel?

Description Turns ON/OFF the offset cancel function for the R_{dc} measurement.

NOTE Turn ON this setup before measuring calibration/compensation data.

Parameters

	Description
ON or 1	Turns ON the offset cancel function.
OFF or 0 (initial value)	Turns OFF the offset cancel function.

Query response {1|0}<newline><^END>

Corresponding key **[System] - SERVICE MENU - RDC OFS CANCEL**

:SOUR:LIST:SIZE?

Syntax :SOURce:LIST:SIZE?

Description Returns the number of measurement points defined in the active table. (Query only)

Query response {numeric}<newline><^END>

Equivalent key sequence No equivalent keys are available on the front panel.

:SOUR:LIST:STAT

Syntax :SOURce:LIST:STATe {ON|OFF|1|0}
 :SOURce:LIST:STATe?

Description Sets the measurement points to be used during measurement.

List measurement The instrument measures the DUT’s characteristics at all points defined in the active table.

Single-point measurement The instrument measures the DUT’s characteristics only at the point specified by issuing the **:SOUR:LIST:POIN** command.

Parameters

	Description
ON or 1	Instructs instrument to perform list measurement
OFF or 0 (initial value)	Instruct instrument to perform single-point measurement

Query response {1|0}<newline><^END>

See also :SOUR:LIST:POIN on page 289

Equivalent key sequence **[Meas View]**

:SOUR:LIST:TABL

Syntax :SOURce:LIST:TABLE <numeric>
 :SOURce:LIST:TABLE?

Description Specifies which table to use as the active table.

Parameters

	<numeric>
Description	Number of the table that should be the active table
Range	1 to 8
Default	1
Resolution	1

If your specified parameter is beyond the valid range, the instrument ignores the parameter and uses either the maximum or minimum value depending on whether the parameter is greater than the upper limit or smaller than the lower limit.

Query response {numeric}<newline><^END>

Equivalent key sequence **[Stml Select] - TABLE No.**

:SOUR:UNIT**:SOUR:UNIT**

Syntax :SOURce:UNIT {DBM|V|A}
:SOURce:UNIT?

Description Lets you select the unit to be used while displaying and setting the oscillator levels.

Parameters

	Description
DBM (initial value)	Uses dBm as display/setting unit
V	Uses mV as display/setting unit
A	Uses mA as display/setting unit

Query response {DBM|V|A}<newline><^END>

Equivalent key sequence **[Setup View]** (Measurement point setup display)

:STAT:OPER?

Syntax	:STATus:OPERation[:EVENT]?
Description	Returns the value of the Operation Status Event register. (Query only)
Query response	{numeric}<newline><^END>
See also	*CLS on page 198
Equivalent key sequence	No equivalent keys are available on the front panel.

:STAT:OPER:COND?

Syntax	:STATus:OPERation:CONDition?
Description	Returns the value of the Operation Status Condition register. (Query only)
Query response	{numeric}<newline><^END>
Equivalent key sequence	No equivalent keys are available on the front panel.

:STAT:OPER:ENAB

Syntax	:STATus:OPERation:ENABle <numeric> :STATus:OPERation:ENABle?
Description	Sets the value of the Operation Status enable register.
Parameters	

	<numeric>
Description	Value of enable register
Range	0 to 32767
Default	0
Resolution	1

If you specify a parameter value beyond the valid range, the command assumes a bit-by-bit logical product (AND) with 32767 (0x7fff).

Query response	{numeric}<newline><^END>
See also	*SRE on page 201 :STAT:PRES on page 295
Equivalent key sequence	No equivalent keys are available on the front panel.

:STAT:OPER:NTR

Syntax :STATus:OPERation:NTRansition <numeric>
:STATus:OPERation:NTRansition?

Description Sets the value of the negative transition filter of the operation status register.

Parameters

	<numeric>
Description	Value of negative transition filter
Range	0 to 32767
Default	0
Resolution	1

If you specify a parameter value beyond the valid range, the command assumes a bit-by-bit logical product (AND) with 32767 (0x7fff).

Query response {numeric}<newline><^END>

See also :STAT:PRES on page 295

Equivalent key sequence No equivalent keys are available on the front panel.

:STAT:OPER:PTR

Syntax :STATus:OPERation:PTRansition <numeric>
:STATus:OPERation:PTRansition?

Description Sets the value of the positive transition filter of operation status register.

Parameters

	<numeric>
Description	Value of positive transition filter
Range	0 to 32767
Default	0
Resolution	1

If you specify a parameter value beyond the valid range, the command assumes a bit-by-bit logical product (AND) with 32767 (0x7fff).

Query response {numeric}<newline><^END>

See also :STAT:PRES on page 295

Equivalent key sequence No equivalent keys are available on the front panel.

:STAT:PRES

- Syntax :STATus:PRESet
- Description Initializes the values of the Operation Status register and Questionable Status register. (No query)
- Equivalent key sequence No equivalent keys are available on the front panel.

:STAT:QUES?

- Syntax :STATus:QUEStionable[:EVENT]?
- Description Returns the value of the Questionable Status Event register. (Query only)
- Query response {numeric}<newline><^END>
- Equivalent key sequence No equivalent keys are available on the front panel.

:STAT:QUES:ENAB

- Syntax :STATus:QUEStionable:ENABle <numeric>
:STATus:QUEStionable:ENABle?
- Description Sets the value of the Questionable Status enable register.
- Parameters

	<numeric>
Description	Value of enable register
Range	0 to 32767
Default	0
Resolution	1

If you specify a parameter value beyond the valid range, the command assumes a bit-by-bit logical product (AND) with 32767 (0x7fff).

- Query response {numeric}<newline><^END>
- See also *SRE on page 201
:STAT:PRES on page 295
- Equivalent key sequence No equivalent keys are available on the front panel.

:SYST:BEEP1

:SYST:BEEP1

Syntax :SYSTem:BEEP1[:IMMEDIATE]

Description Generates a beep to notify the user that a particular operation is complete. (No query)

See also :SYST:BEEP1:STAT on page 296

Equivalent key sequence **[System] - BEEPER MENU - PLAY BEEP DONE**

:SYST:BEEP1:STAT

Syntax :SYSTem:BEEP1:STATe {ON|OFF|1|0}

Description Specifies whether to enable the beep mechanism used to notify the user that a particular operation (such as measuring the calibration data) is complete.

Parameters

	Description
ON or 1 (initial value)	Enables beep mechanism
OFF or 0	Disables beep mechanism

Query response {1|0}<newline><^END>

Equivalent key sequence **[System] - BEEPER MENU - BEEP DONE**

:SYST:BEEP2

Syntax :SYSTem:BEEP2[:IMMEDIATE]

Description Generates a beep to notify the user that a warning condition has occurred or that the comparator has returned a result. (No query)

See also :SYST:BEEP2:STAT on page 297

Equivalent key sequence **[System] - BEEPER MENU - PLAY BEEP WARN**

:SYST:BEEP2:STAT

Syntax :SYSTem:BEEPer2:STATe {ON|OFF|1|0}

Description Specifies whether to enable the beep mechanism used to notify the user of a warning condition or a comparator result.

Parameters

	Description
ON or 1 (initial value)	Enables beep mechanism
OFF or 0	Disables beep mechanism

Query response {1|0}<newline><^END>

See also :CALC:COMP:BEEP:COND on page 205

Equivalent key sequence **[System] - BEEPER MENU - BEEP WARN**

:SYST:DATE

Syntax :SYSTem:DATE <year>,<month>,<day>
:SYSTem:DATE?

Description Sets the date of the 4287A's internal clock.

Parameters

	<year>	<month>	<day>
Description	Year part of the date	Month part of the date	Day part of the date
Range	1980 to 2099	1 to 12	1 to 31
Resolution	1	1	1

If your specified parameter is beyond the valid range, the command fails and an error is generated.

Query response {year},{month},{day}<newline><^END>

See also :SYST:TIME on page 301

Equivalent key sequence **[System] - SET DATE & TIME**

:SYST:ERR?

:SYST:ERR?

Syntax :SYSTem:ERRor?

Description Returns the oldest error from the 4287A's error queue. The size of the error queue is 100. You can use the ***CLS** command to clear all errors contained in the error queue. (Query only)

NOTE This commands cannot return an error that occurs by manual operation using the front panel, the mouse or keyboard.

Query response {numeric},{string}<newline><^END>

{numeric}: Error number

{string}: Error message (a double-quoted string)

If the error queue contains no error, the command returns zero for the error number and "No error" for the error message.

See also *CLS on page 198

Equivalent key sequence No equivalent keys are available on the front panel.

:SYST:ERR:COUN?

Syntax :SYSTem:ERRor:COUNt?

Description Returns the number of errors contained in the error queue. (Query only)

Query response {numeric}<newline><^END>

Equivalent key sequence No equivalent keys are available on the front panel.

:SYST:EXTR?

Syntax :SYSTem:EXTRef?

Description Returns whether the external reference signal is inputted through the Ext Ref In connector on the rear panel. (Query only)

Query response {1|0}<newline><^END>

	Description
1	External reference signal is inputted
0	External reference signal is not inputted

Equivalent key sequence No equivalent keys are available on the front panel.

:SYST:KLOC

Syntax :SYSTem:KLOCK[:FPANel] {ON|OFF|1|0}
:SYSTem:KLOCK[:FPANel]?

Description Specifies whether to lock the front panel key, rotary knob and key board.
This command has the same function as :SYST:KLOC:KBD command.

Parameters

	Description
ON or 1	Locked
OFF or 0 (initial value)	Unlocked

Query response {1|0}<newline><^END>

See also :SYST:KLOC:KBD on page 299
:SYST:KLOC:MOUS on page 300

Equivalent key sequence **[System] - KEY LOCK MENU - FPANEL LOCK**

:SYST:KLOC:KBD

Syntax :SYSTem:KLOCK:KBD {ON|OFF|1|0}
:SYSTem:KLOCK:KBD?

Description Specifies whether to lock the front panel key, rotary knob and key board.
This command has the same function as :SYST:KLOC command.

Parameters

	Description
ON or 1	Locked
OFF or 0 (initial value)	Unlocked

Query Response {1|0}<newline><^END>

See also :SYST:KLOC on page 299
:SYST:KLOC:MOUS on page 300

Equivalent key sequence **[System] - KEY LOCK MENU - KBD LOCK**

:SYST:KLOC:MOUS

Syntax :SYSTem:KLOCK:MOUSe {ON|OFF|1|0}
:SYSTem:KLOCK:MOUSe?

Description Specifies whether to lock the mouse.

Parameters

	Description
ON or 1	Locked
OFF or 0 (initial value)	Unlocked

Query Response {1|0}<newline><^END>

See also :SYST:KLOC on page 299
:SYST:KLOC:KBD on page 299

Equivalent key sequence **[System] - KEY LOCK MENU - MOUSE LOCK**

:SYST:POFF

Syntax :SYSTem:PRESet

Description Turns off the power to the 4287A. (No query)

Equivalent key sequence standby switch

:SYST:PRES

Syntax :SYSTem:PRESet

Description Resets the instrument to its preset state. This command works similarly to the ***RST** command, except that it: (No query)

- Turns on the continuous activation of the trigger system.
- Has no effect on the data transfer format setting.

See also *RST on page 200

Equivalent key sequence **[Preset]**

:SYST:TIME

Syntax :SYSTem:TIME <hour>,<min>,<sec>
 :SYSTem:TIME?

Description Sets the time of the 4287A's internal clock.

Parameters

	<hour>	<min>	<sec>
Description	Hour part of the time (in the 24-hour format)	Minute part of the time	Second part of the time
Range	0 to 23	0 to 59	0 to 59
Resolution	1	1	1

If your specified parameter is beyond the valid range, the command fails and an error is generated.

Query Response {hour},{min},{sec}<newline><^END>

See also :SYST:DATE on page 297

Equivalent key sequence **[System] - SET DATE & TIME**

:SYST:VERS?

Syntax :SYSTem:VERSion?

Description Returns the SCPI version number the instrument complies with. (Query only)

Query Response {string}<newline><^END>

The command returns a string in a YYYY.V format. The YYYY part of this string indicates the year version while the V part indicates the version number within that year.

Equivalent key sequence No equivalent keys are available on the front panel.

:TRIG

:TRIG

Syntax :TRIGger[:SEQuence1][:IMMediate]

Description When the trigger system is in trigger event detect state, you can use this command to immediately trigger the instrument to start measurement, regardless of the trigger setting. If the trigger system is not in trigger event detect state, however, issuing the command generates an error. For more information on the trigger system, see “Trigger system” on page 66. (No query)

Equivalent key sequence No equivalent keys are available on the front panel.

:TRIG:DEL

Syntax :TRIGger[:SEQuence1]:DELay <numeric>
:TRIGger[:SEQuence1]:DELay?

Description Specifies the wait time (trigger delay time) between triggering and the start of single-point or list measurement.

Parameters

	<numeric>
Description	Trigger delay time
Range	0 to 1
Default	0
Unit	s (seconds)
Resolution	100E-6

If your specified parameter is beyond the valid range, the instrument ignores the parameter and uses either the maximum or minimum value depending on whether the parameter is greater than the upper limit or smaller than the lower limit.

Query Response {numeric}<newline><^END>

See also :TRIG:SEQ2:DEL on page 303

Equivalent key sequence **[Trigger Mode] - SETUP DELAY - TRIGGER DELAY**

:TRIG:SEQ2:DEL

Syntax :TRIGger:SEQuence2:DELay <numeric>
:TRIGger:SEQuence2:DELay?

Description Specifies the pre-measurement wait time (measurement point delay time) for each measurement point.

Parameters

	<numeric>
Description	Measurement point delay time
Range	0 to 1
Default	0
Unit	s (seconds)
Resolution	100E-6

If your specified parameter is beyond the valid range, the instrument ignores the parameter and uses either the maximum or minimum value depending on whether the parameter is greater than the upper limit or smaller than the lower limit.

Query Response {numeric}<newline><^END>

See also :TRIG:DEL on page 302

Equivalent key sequence **[Trigger Mode] - SETUP DELAY - POINT DELAY**

:TRIG:SLOP

Syntax :TRIGger:SLOPe {POSitive|NEGative}
:TRIGger:SLOPe?

Description Sets the polarity of the external trigger signal input through the rear panel EXT TRIGGER terminal and the handler interface.

Parameters

	Description
POSitive (initial value)	Positive (triggering at the rising edge from the LOW level to the HIGH level)
NEGative	Negative (triggering at the falling edge from the HIGH level to the LOW level)

Query Response {POS|NEG}<newline><^END>

Equivalent key sequence **[Trigger Mode] - TRIG PRLTY**

:TRIG:SOUR

Syntax :TRIGger[:SEQuence1]:SOURce {INTernal|MANual|EXTernal|BUS}
 :TRIGger[:SEQuence1]:SOURce?

Description Lets you select one of the following four trigger sources:

Internal	Configures the instrument to use its internal trigger source so that is it automatically and continuously triggered.
Manual	Configures the instrument to be triggered when you press the [Trigger] key on the front panel.
External	Configures the instrument to be triggered when a trigger signal is input through the Ext TRIGGER terminal or handler interface.
GPIB/LAN	Configures the instrument to be triggered when the *TRG command on page 202 is issued.

Parameters

	Description
INTernal (initial value)	Internal trigger source
MANual	Manual trigger
EXTernal	External trigger source
BUS	GPIB/LAN trigger

Query Response {INT|MAN|EXT|BUS}<newline><^END>

Equivalent key sequence **[Trigger Mode] - TRIG SOURCE - {INTERNAL | MANUAL | EXTERNAL | BUS}**

Service command

This section describes the command for service engineers. If you use the command shown in this section, accuracy of measurement is not guaranteed.

:SOUR:LIST:RDC:AVER

Syntax :SOURce:LIST:RDC:AVERage <numeric>
:SOURce:LIST:RDC:AVERage?

Description Sets the averaging factor of the R_{dc} measurement.
For maximum reduction of measurement variations by ac line noise at measurements for service, set the averaging factor to following number.

When ac line frequency is 50 Hz: 2000

When ac line frequency is 60 Hz: 1667

Parameters

	<numeric>
Description	Averaging factor
Range	1 to 6000
Default	128
Resolution	1

If your specified parameter is beyond the valid range, the instrument ignores the parameter and uses either the maximum or minimum value depending on whether the parameter is greater than the upper limit or smaller than the lower limit.

Query response {numeric}<newline><^END>

Equivalent key sequence No equivalent keys are available on the front panel.

A **Manual Changes**

This appendix contains the information required to adapt this manual to earlier versions or configurations of the Agilent 4287A than that indicated by the current printing date of this manual. The information in this manual applies directly to the 4287A model that has the serial number prefix listed on the title page of this manual.

Manual Changes

To adapt this manual to your Agilent 4287A, refer to Table A-1 and Table A-2.

Table A-1 **Manual Changes by Serial Number**

Serial Prefix or Number	Make Manual Changes
JP1KG, MY432	“Change 3” on page 309

Table A-2 **Manual Changes by Firmware Version**

Version	Make Manual Changes
1.1x	“Change 1” on page 309, “Change 2” on page 309
1.20	“Change 2” on page 309
1.x	“Change 3” on page 309

Agilent Technologies uses a two-part, ten-character serial number that is stamped on the serial number plate (Figure A-1). The first five characters are the serial prefix and the last five digits are the suffix.

Execute the *IDN? command on page 199 to check the firmware version.

Figure A-1 **Example of Serial Number Plate**

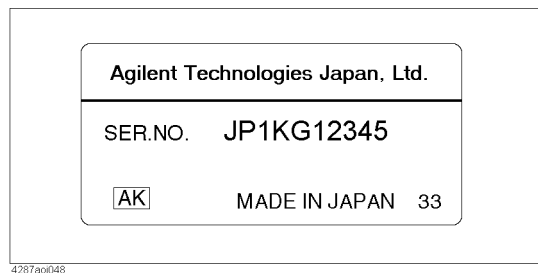

4287ayj048

Change 1

The firmware revision 1.1x dose not support the following commands. Please delete the descriptions about these commands in this manual.

- :AVER:COUN command on page 204
- :MMEM:CAT? command on page 282
- :MMEM:COPY command on page 283
- :MMEM:CRE:DIR command on page 283
- :MMEM:DEL command on page 284

Change 2

The firmware revision 1.1x, and 1.20 dose not support the following commands. Please delete the descriptions about these commands in this manual.

- :DISP:CCL command on page 263
- :SOUR:LIST:RDC:OFSC command on page 290

Change 3

The function of :SYST:KLOC and :SYST:KLOC:KBD are different. Please refer to the following explanation.

:SYST:KLOC

Syntax

```
:SYSTem:KLOCK[:FPANel] {ON|OFF|1|0}
:SYSTem:KLOCK[:FPANel]?
```

Description

Specifies whether to lock the front panel key and rotary knob.

Parameters

	Description
ON or 1	Locked
OFF or 0 (initial value)	Unlocked

Query response

```
{1|0}<newline><<^END>
```

See also

:**SYST:KLOC:KBD** on page 309
:SYST:KLOC:MOUS (page 300)

Equivalent key sequence

[System] - KEY LOCK MENU - FPANEL LOCK
:**SYST:KLOC:KBD**

Syntax

```
:SYSTem:KLOCK:KBD {ON|OFF|1|0}
```

Manual Changes
Manual Changes

:SYSTem:KLOCK:kBD?

Description Specifies whether to lock the keyboard.

Parameters

	Description
ON or 1	Locked
OFF or 0 (initial value)	No effect (if you want to unlock the keyboard, you need to reboot the 4287A)

Query Response {1|0}<newline><^END>

See also :SYST:KLOC
:SYST:KLOC:MOUS

Equivalent key sequence [System] - KEY LOCK MENU - KBD LOCK

B **Status Reporting System**

This appendix describes the status reporting system of the Agilent 4287A.

General Status Register Model

The Agilent 4287A has a status reporting system to report the condition of the instrument.

Figure B-1

General Status Register Model

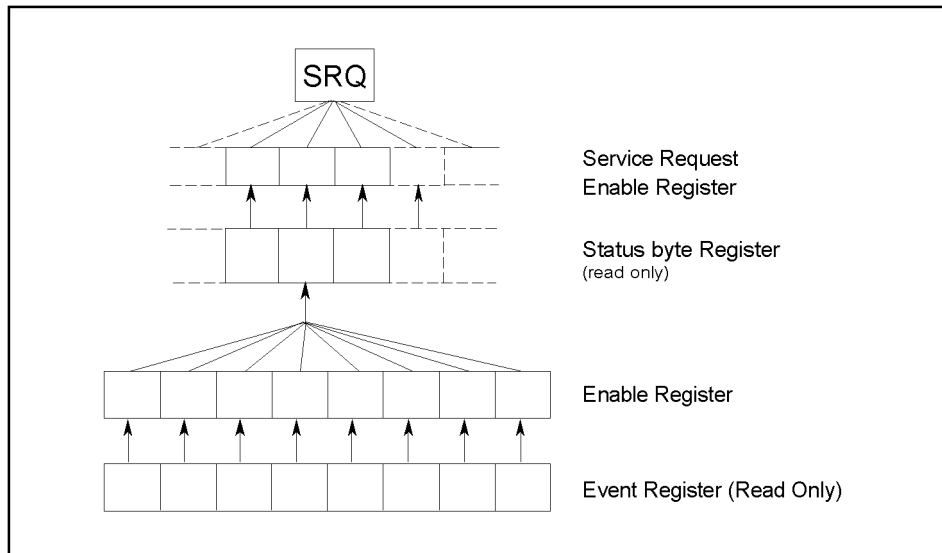

The status reporting system has a hierarchical structure as shown in Figure B-1. When the instrument satisfies a particular condition, the corresponding bit of the event register is set to 1. Therefore, you can check the instrument status by reading the event register.

When the event register bit is set to “1” and a corresponding enable register bit (a bit marked with an arrow in Figure B-1) is also “1,” the summary bit of the status byte register is set to “1.” You can read the status byte register by using the serial poll.

If the bit of the service request enable register is “1,” a service request (SRQ) is generated by the positive transition of the corresponding status byte register bit. By generating SRQ, you can notify the controller that the 4287A is requesting service. In other words, interruption by SRQ can be programmed. For more information on using SRQ, see “Waiting for (Detecting) End of Measurement” on page 70 in Chapter 5, “Starting Measurement Cycle (Triggering) and Detecting End of Measurement,” or “Using the Status Reporting System” on page 135 in Chapter 10, “Error Handling.”

Event register

The event register reflects the corresponding condition of the 4287A (e.g., occurrence of an event) as a bit status. These bits continuously monitor changes in the 4287A's state and change the bit status when the condition (e.g., change bit status to "1" if a specific event occurs) for each bit is met. You cannot change the bit status by issuing a GPIB command.

The Agilent 4287A has the following event registers:

- Standard Event Status Register (see Table B-2 for details.)
- Operation Status Event Register (see Table B-3 for details.)
- Questionable Status Event Register (see Table B-4 for details.)

Enable register

Setting the enable register allows you to specify event register bits that can set "1" to the summary bit of the status byte register when an event occurs. The register bits work as mask bits; setting "1" to an enable register will enable a corresponding bit in the event register.

For example, when you want to set "1" as the summary bit in the status byte register by a specific register condition, set the corresponding enable register to "1."

Status byte register

If the enabled event register is set to "1," a corresponding bit of the status byte register is also set to "1." This register also indicates the output queue and SRQ status.

The value of the status byte register can be read by using the ***STB?** command on page 201 or the serial poll (SPOLL statement in HP BASIC) from the controller.

Reading the status byte register by using the ***STB?** command does not affect the contents of the status byte register. However, reading it with the SPOLL statement of HP BASIC will clear the RQS bit in the status byte register.

Setting the service request enable register using the ***SRE** command on page 201 can generate a service request synchronously with the status byte register.

Condition register and transition filter

When the status register has a transition filter, there is a lower register called a condition register under the event register. The transition filter is between the event register and the condition register.

The transition filter enables you to select a positive and/or negative transition of the condition register bit in order to set a bit in the corresponding event register. For example, using the negative transition filter to set bit 3 to “1” causes bit 3 of the event register to be set to “1” when bit 3 of the condition register makes a negative transition, that is, changes from 1 to 0,

Figure B-2

Transition filter and condition register

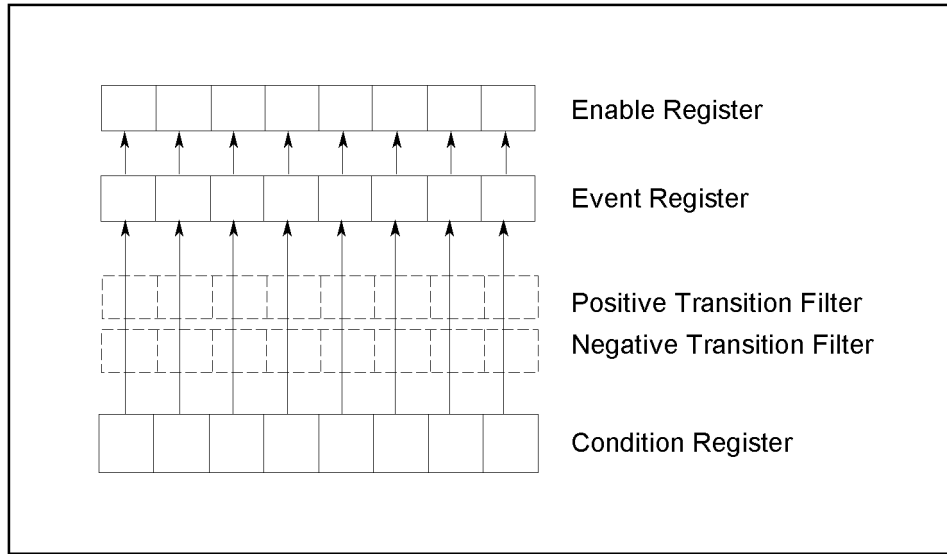

4294ape022

The 4287A's condition register and transition filter work only with the operation status register.

Status Register Structure

The status reporting system has a hierarchical structure as shown in Figure B-3. The status byte register is a summary of registers in the lower level. This section describes status registers in each hierarchy. Each bit of the status register is described in Table B-1 through Table B-4.

Figure B-3 Status Register Structure

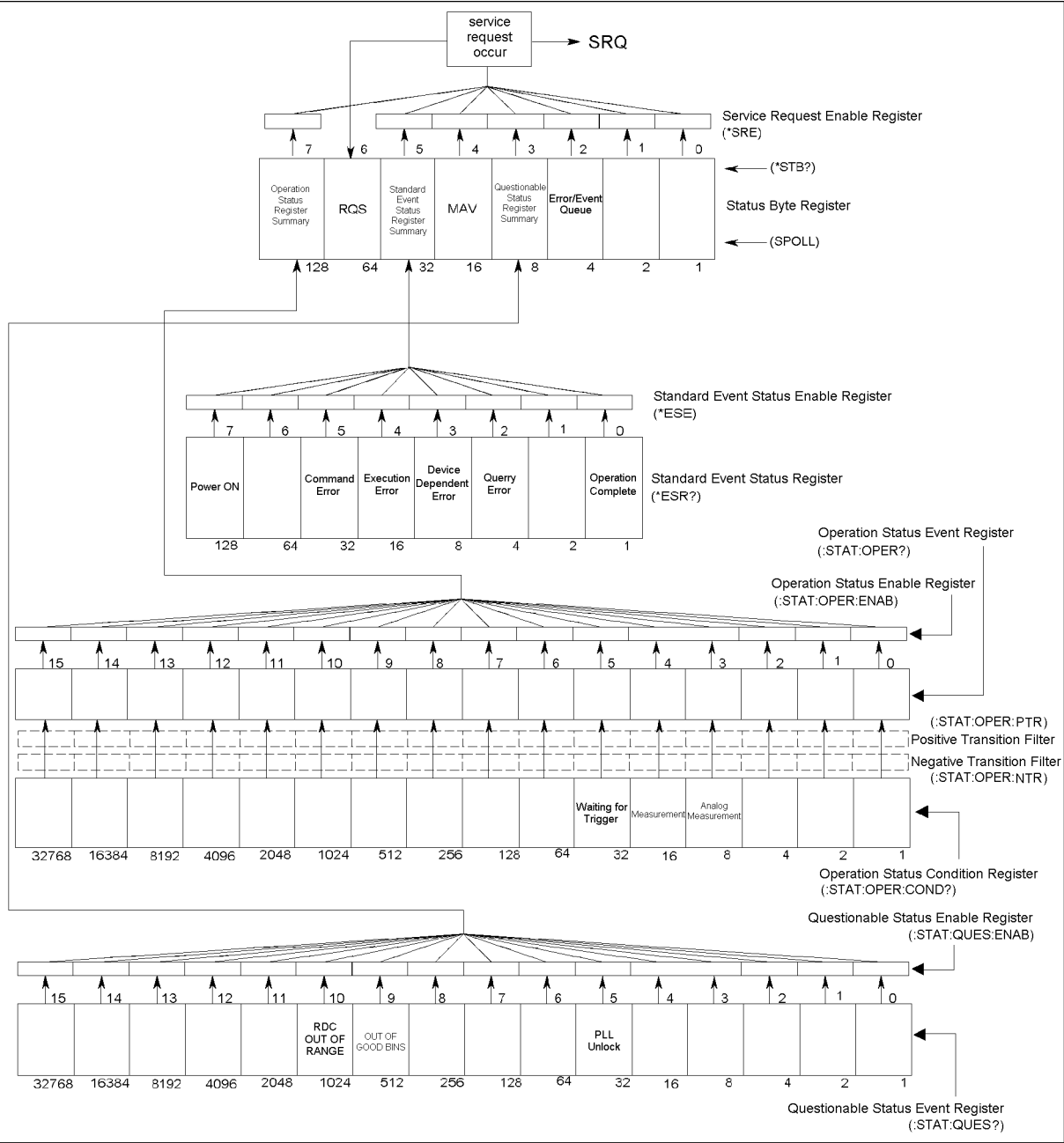

4287ape001

Table B-1

Status Bit Definitions of Status Byte (STB)

Bit Position	Name	Description
0, 1	Not used	Always 0
2	Error/Event Queue	Set to "1" if the error/event queue contains data; reset to "0" when all of the data has been retrieved.
3	Questionable Status Register Summary	Set to "1" when one of the enabled bits in the status event status register is set to "1."
4	MAV (Message Available)	Set to "1" when the output queue contains data; reset to "0" when all of the data has been retrieved.
5	Standard Event Status Register Summary	Set to "1" when one of the enabled bits in the status event status register is set to "1."
6	RQS	Set to "1" when any of the status byte register bits enabled by the service request enable register is set to "1"; reset to "0" when all of the data has been retrieved through serial polling.
7	Operation Status Register Summary	Set to "1" when one of the enabled bits in the operational status register is set to "1."

Issuing the ***CLS** command will clear all bits from the status byte register.

Table B-2

Status Bit Definitions of Event Status Register (ESR)

Bit Position	Name	Description
0	Operation Complete	Set to "1" upon completion of all operations done by commands that precede the *OPC command on page 199.
1	Not used	Always 0
2	Query Error	<ol style="list-style-type: none"> Set to "1" when the 4287A receives a data output request but there is no data to output. Set to "1" when the data of the 4287A's output queue has been cleared because of a new message received before the completion of data output.
3	Device Dependent Error	Set to "1" when an error has occurred and the error is not a command, query, or execution error.
4	Execution Error	<ol style="list-style-type: none"> Set to "1" when any parameter in a GPIB command exceeds its input range or is inconsistent with the 4287A's capabilities. Set to "1" when a GPIB command cannot be properly executed due to some condition of the 4287A.
5	Command Error	<ol style="list-style-type: none"> Set to "1" when an IEEE 488.2 syntax error occurs (a command sent to the 4287A does not follow the IEEE 488.2 syntax). Possible violations include the command parameter violating the 4287A listening formats or being unacceptable. Set to "1" when a semantic error occurs. Possible causes include a command containing misspellings being sent to the 4287A or an IEEE 488.2 command that is not supported by the 4287A being sent. Set to "1" when GET (Group Execution Trigger) is input while a program message is being received.
6	Not used	Always 0
7	Power ON	Set to "1" when the 4287A is powered ON.

B: Status Reporting System

Issuing the ***CLS** command will clear all bits from the standard event status register.

Table B-3

Status Bit Definitions of the Operation Status Condition Register

Bit Position	Name	Description
0 to 2	Not used	Always 0
3	Analog Measurement	Set to “1” during analog measurement* ¹ .
4	Measurement	Set to “1” during measurement* ² .
5	Waiting for Trigger	Set to “1” when the instrument is waiting for a trigger* ³ .
6 to 15	Not used	Always 0

*1. This is when the handler interface’s /INDEX signal is active.

*2. This is when the handler interface’s /EOM signal is active.

*3. This is when the trigger system is in trigger wait state. For more information on the trigger system, refer to “Trigger system” on page 66.

Issuing the ***CLS** command will clear all bits from the operation status event register.

Table B-4

Status Bit Definitions of Questionable Status Event Register

Bit Position	Name	Description
0 to 4	Not used	Always 0
5	PLL Unlock	Set to “1” when a PLL unlock occurs.
6 to 8	Not used	Always 0
9	OUT OF GOOD BINS	Set to “1” when the bin sorting result is OUT OF GOOD BINS* ¹ .
10	RDC OUT OF RANGE	Set to “1” when the result of R _{dc} measurement fails to fall within the specified limit range.
11 to 15	Not used	Always 0

*1. This is when the handler interface’s /OUT_OF_GOOD_BINS is active (the DUT is sorted into the bad bin or not sorted into any bin).

Issuing the ***CLS** command will clear all bits from the questionable status event register.

Using the Status Reporting System

You can manage the status report system using the following commands in any combination:

- *CLS on page 198
- *SRE on page 201
- *STB? on page 201
- *ESE on page 198
- *ESR? on page 199
- :STAT:PRES on page 295
- :STAT:OPER:ENAB on page 293
- :STAT:OPER:COND? on page 293
- :STAT:OPER? on page 293
- :STAT:OPER:PTR on page 294
- :STAT:OPER:NTR on page 294
- :STAT:QUES? on page 295
- :STAT:QUES:ENAB on page 295

For sample programs that demonstrate the use of the commands listed above, refer to “Waiting for (Detecting) End of Measurement” on page 70 in Chapter 5 or “Using the Status Reporting System” on page 135 in Chapter 10.

NOTE

You cannot use the *STB? command in telnet session. Refer Figure B-3, “Status Register Structure,” and use the command to read lower level registers of the status byte register.

Status Reporting System
Using the Status Reporting System

C GPIB Command Table

This appendix provides the Agilent 4287A GPIB command list sorted according to function.

GPIB Command Table

The following table lists the 4287A GPIB commands sorted according to function. See Chapter 15, “Command Reference,” on page 195 for detailed information on the 4287A GPIB commands.

Function	Setting/Operation		GPIB Command
Measurement Condition	Reset	Turns off the continuous activation of the trigger system.	*RST (page 200)
		Turns on the continuous activation of the trigger system.	:SYST:PRES (page 300)
	Measurement parameter		:CALC:PAR{1-4}:FORM (page 224)
	List measurement On/Off		:SOUR:LIST:STAT (page 291)
	Measurement point for single-point measurement		:SOUR:LIST:POIN (page 289)
	Active table		:SOUR:LIST:TABL (page 291)
Measurement point setup table (stimulus setup table)		Clear	:SOUR:LIST:CLE (page 289)
		Unit of oscillator level	:SOUR:UNIT (page 292)
		Oscillator (frequency, level) and averaging factor	:SOUR:LIST (page 288)
		Averaging factor	:AVER:COUN (page 204)
		Reads the number of measurement points	:SOUR:LIST:SIZE? (page 290)
R _{dc} measurement	On/Off		:SOUR:LIST:RDC (page 290)
		Offset cancel function On/Off	:SOUR:LIST:RDC:OFSC (page 290)
		Limit range	:CALC:COMP:RDC:LIM (page 218)
Deviation measurement	On/Off		:CALC:PAR{1-4}:EXPR:STAT (page 223)
		Mode	:CALC:PAR{1-4}:EXPR:NAME (page 223)
		Reference value	:CALC:PAR{1-4}:EXPR:CENT (page 222)
Delay time		Trigger delay	:TRIG:DEL (page 302)
		Measurement point delay	:TRIG:SEQ2:DEL (page 303)

Function	Setting/Operation		GPIB Command	
Calibration	Calibration kit selection		:CORR1:CKIT (page 225)	
	Standard definition for user calibration kit	Impedance definition method (fixed/point-by-point)		:CORR1:CKIT:LIST (page 226)
		Open	Impedance value (G and Cp)	:CORR1:CKIT:STAN1:LIST (page 229)
			Dc conductance value	:CORR1:CKIT:STAN1:DC (page 227)
			Offset delay	:CORR1:CKIT:STAN1:EDEL (page 228)
		Short	Impedance value (Rs and Ls)	:CORR1:CKIT:STAN2:LIST (page 232)
			Dc resistance value (R_{dc})	:CORR1:CKIT:STAN2:DC (page 230)
			Offset delay	:CORR1:CKIT:STAN2:EDEL (page 231)
		Load	Definition impedance parameter type	:CORR1:CKIT:STAN3:FORM (page 235)
			Impedance value	:CORR1:CKIT:STAN3:LIST (page 236)
			Dc resistance value (R_{dc})	:CORR1:CKIT:STAN3:DC (page 233)
			Offset delay	:CORR1:CKIT:STAN3:EDEL (page 234)
		Measurement of data for calibration coefficient calculation	Data for Impedance and R_{dc} measurement	:CORR1:COLL (page 238)
	Data for Impedance measurement		:CORR1:COLL:RF (page 240)	
	Data for R_{dc} measurement		:CORR1:COLL:DC (page 239)	
	Checks calibration status (On/Off)		:CORR1? (page 225)	
Calculates the calibration coefficient and turns on the calibration function		:CORR1:COLL:SAVE (page 240)		

[GPIB Command Table](#)
[GPIB Command Table](#)

Function	Setting/Operation		GPIB Command	
Compensation	Selection of standard values (default values/user defined values)		:CORR2:CKIT (page 241)	
	Standard definition	Impedance definition method (fixed/point-by-point)		:CORR2:CKIT:LIST (page 241)
		Open	Impedance value (G and Cp)	:CORR2:CKIT:STAN1:LIST (page 243)
			Dc conductance value	:CORR2:CKIT:STAN1:DC (page 242)
		Short	Impedance value (Rs and Ls)	:CORR2:CKIT:STAN2:LIST (page 245)
			Dc resistance value (R_{dc})	:CORR2:CKIT:STAN2:DC (page 244)
	Measurement of data for compensation coefficient calculation	Data for Impedance and R_{dc} measurement		:CORR2:COLL (page 246)
		Data for Impedance measurement		:CORR2:COLL:RF (page 248)
		Data for R_{dc} measurement		:CORR2:COLL:DC (page 247)
	Calculates the compensation coefficient and turns on the compensation function			:CORR2:COLL:SAVE (page 249)
	Open compensation function On/Off			:CORR2:COLL:OPEN (page 248)
Short compensation function On/Off			:CORR2:COLL:SHOR (page 249)	
Test fixture selection (port extension compensation function)	Fixture selection		:CORR2:FIXT (page 250)	
	User fixture setting	Electrical length	:CORR2:FIXT:EDEL:DIST (page 251)	
		Fixture name	:CORR2:FIXT:LAB (page 252)	

Function	Setting/Operation			GPIB Command	
Comparator (BIN sort)	On/Off			:CALC:COMP (page 205)	
	Reads comparator result			:CALC:COMP:DATA:BIN? (page 215)	
	Beep mode			:CALC:COMP:BEEP:COND (page 205)	
	Fixes the boundary line between good BIN and no good BIN			:CALC:COMP:OGB (page 217)	
	BIN setting	Clears all settings			:CALC:COMP:CLE (page 208)
		On/Off of each BIN			:CALC:COMP:BIN{1-13} (page 206)
	Sorting condition setting	For all BINs	Measurement point number	:CALC:COMP:COND{1-4}:SNUM (page 212)	
			Parameter	:CALC:COMP:COND{1-4}:PAR (page 211)	
			limit mode	:CALC:COMP:COND{1-4}:MODE (page 209)	
			Nominal value	:CALC:COMP:COND{1-4}:NOM (page 210)	
		For each BIN	Limit range	:CALC:COMP:BIN{1-13}:COND{1-4}:LIM (page 207)	
			BIN range mode	:CALC:COMP:BIN{1-13}:COND{1-4}:LTY P (page 208)	
	BIN counter	On/Off			:CALC:COMP:COUN (page 213)
		Count number	Clear	:CALC:COMP:COUN:CLE (page 213)	
			Read	:CALC:COMP:DATA:BCOU? (page 214)	
R _{dc} measurement comparator (for contact check)	Limit range			:CALC:COMP:RDC:LIM (page 218)	
	Evaluation result			:CALC:COMP:DATA:RDC? (page 216)	
Trigger	Triggering			:TRIG (page 302)	
	Triggering and measurement data reading			*TRG (page 202)	
	Trigger source			:TRIG:SOUR (page 304)	
	Polarity of external trigger			:TRIG:SLOP (page 303)	
	Delay time	Trigger delay		:TRIG:DEL (page 302)	
		Measurement point delay		:TRIG:SEQ2:DEL (page 303)	
	Trigger system	Reset			:ABOR (page 203)
		Initiates once			:INIT (page 281)
		Continuous activation On/Off			:INIT:CONT (page 281)

[GPIB Command Table](#)
 [GPIB Command Table](#)

Function	Setting/Operation		GPIB Command
Data read/write	Data transfer format	Sets the format	:FORM (page 276)
		Sets the byte order of binary transfer format	:FORM:BORD (page 277)
	Triggers and reads measurement data		*TRG (page 202)
	Reads measurement data		:FETC? (page 274)
	Reads measurement data when measurement completed after triggering		:READ? (page 287)
	Reads measurement data array		:DATA:RAW? (page 258)
	Reads display data array		:DATA:FDAT{1-4}? (page 257)
	R _{dc} measurement	Reads R _{dc} measurement result	:DATA:RDC? (page 261)
		Reads comparator evaluation result	:CALC:COMP:DATA:RDC? (page 216)
	Test signal level monitor	Reads current level	:DATA:IMON? (page 257)
		Reads voltage level	:DATA:VMON? (page 261)
	Reads/writes calibration coefficients		:DATA:CCO{1-6} (page 254)
	Reads data to calculate calibration coefficients		:DATA:CAD{1-8}? (page 253)
	Reads/writes calibration coefficients for R _{dc} measurement		:DATA:RCCO{1-3} (page 259)
	Reads data to calculate calibration coefficients for R _{dc} measurement		:DATA:RCAD{1-3}? (page 259)
	Reads/writes compensation coefficients		:DATA:CMP{1-3} (page 256)
	Reads data to calculate compensation coefficients		:DATA:CMD{1-2}? (page 255)
	Reads/writes compensation coefficients for R _{dc} measurement		:DATA:RCMP{1-3} (page 260)
	Reads data to calculate compensation coefficients for R _{dc} measurement		:DATA:RCMD{1-2}? (page 260)
	Reads BIN sort result		:CALC:COMP:DATA:BIN? (page 215)
Reads BIN count result		:CALC:COMP:DATA:BCOU? (page 214)	
Statistical analysis	Executes statistical analysis and reads its results		:CALC:EXAM:GET? (page 219)
	Starts logging data for statistical analysis		:CALC:EXAM:STAR (page 222)
	Sets maximum data size		:CALC:EXAM:SIZE (page 221)
	Reads logged data size		:CALC:EXAM:POIN? (page 220)

Function	Setting/Operation	GPIB Command	
Status report structure	Clears registers		*CLS (page 198)
	Reads status byte register		*STB? (page 201)
	Reads service request enable register		*SRE (page 201)
	Standard event status register	Reads register	*ESR? (page 199)
		Sets enable register	*ESE (page 198)
		Setting of OPC bit when operation finishes	*OPC (page 199)
	Operation status register	Resets	:STAT:PRES (page 295)
		Reads condition register	:STAT:OPER:COND? (page 293)
		Sets enable register	:STAT:OPER:ENAB (page 293)
		Reads event register	:STAT:OPER? (page 293)
		Sets positive transition filter	:STAT:OPER:PTR (page 294)
		Sets negative transition filter	:STAT:OPER:NTR (page 294)
	Questionable status register	Resets	:STAT:PRES (page 295)
		Sets enable register	:STAT:QUES:ENAB (page 295)
		Reads event register	:STAT:QUES? (page 295)
Save/Recall and file management	Save		:MMEM:STOR (page 285)
	Recall		:MMEM:LOAD (page 284)
	Copy		:MMEM:COPY (page 283)
	Creates a new directory (folder)		:MMEM:CRE:DIR (page 283)
	Deletes an existing file or directory		:MMEM:DEL (page 284)
	Reads the information about a storage device		:MMEM:CAT? (page 282)
	Printer	Selection of printer	
Reads information of available printers		:HCOP:PRIN? (page 280)	
Print out		Executes	:HCOP (page 278)
		Aborts	:HCOP:ABOR (page 278)
Print setting		Contents	:HCOP:CONT (page 278)
		Color	:HCOP:IMAG (page 280)

GPIB Command Table
 GPIB Command Table

Function	Setting/Operation		GPIB Command	
Display	LCD's backlight On/Off		:DISP:BACK (page 262)	
	Display On/Off		:DISP (page 262)	
	Update On/Off		:DISP:UPD (page 273)	
	Results	Display On/Off		:DISP:TEXT1 (page 263)
		Result of measurement parameter 1 to 4	Display On/Off	:DISP:TEXT1:CALC{1-4} (page 264)
			Number of digits	:DISP:TEXT1:CALC{1-4}:DIG (page 264)
			Fixed decimal point mode On/Off	:DISP:TEXT1:CALC{1-4}:FIX (page 265)
			Most significant digit	:DISP:TEXT1:CALC{1-4}:MSD (page 265)
		Result of test signal level monitor	Display On/Off	:DISP:TEXT1:CALC{11-12} (page 266)
			Number of digits	:DISP:TEXT1:CALC{11-12}:DIG (page 266)
			Fixed decimal point mode On/Off	:DISP:TEXT1:CALC{11-12}:FIX (page 267)
			Most significant digit	:DISP:TEXT1:CALC{11-12}:MSD (page 267)
		Result of R _{dc} measurement	Number of digits	:DISP:TEXT1:CALC13:DIG (page 268)
			Fixed decimal point mode On/Off	:DISP:TEXT1:CALC13:FIX (page 268)
			Most significant digit	:DISP:TEXT1:CALC13:MSD (page 269)
	Title	Display On/Off	:DISP:TEXT10 (page 270)	
		Title characters	:DISP:TEXT10:DATA (page 270)	
Time and date	Display On/Off	:DISP:TEXT11 (page 271)		
	Update On/Off	:DISP:TEXT11:MODE (page 271)		
Displayed item in list measurement display		:DISP:TEXT2:LAB{1-4} (page 272)		
Clears the displayed error message		:DISP:CCL (page 263)		
Key lock	Front panel key		:SYST:KLOC (page 299)	
	Keyboard		:SYST:KLOC:KBD (page 299)	
	Mouse		:SYST:KLOC:MOUS (page 300)	
Beeper	Beep to notify the completion of operation	On/Off	:SYST:BEEP1:STAT (page 296)	
		Generation of a beep	:SYST:BEEP1 (page 296)	
	Beep to notify an error/warning or sorting results	On/Off	:SYST:BEEP2:STAT (page 297)	
		Generation of a beep	:SYST:BEEP2 (page 296)	
Internal clock	Sets the date	:SYST:DATE (page 297)		
	Sets the time	:SYST:TIME (page 301)		

Function	Setting/Operation	GPIB Command	
Other functions	Shutdown	:SYST:POFF (page 300)	
	Executes the self-test	*TST? (page 202)	
	Reads product information	*IDN? (page 199)	
	Reads error queue	Error number and error message	:SYST:ERR? (page 298)
		Number of errors	:SYST:ERR:COUN? (page 298)
	Checks whether the external reference signal is inputted at Ext Ref In terminal	:SYST:EXTR? (page 298)	
	Reads the SCPI version	:SYST:VERS? (page 301)	
	Waits for the completion of operation	*WAI (page 202)	
	Reads 1 when operation is complete	*OPC? (page 199)	
	Sets 1 to OPC bit when operation is complete	*OPC (page 199)	

GPIB Command Table
GPIB Command Table

D **GPIB Command Tree**

This appendix provides the Agilent 4287A GPIB command tree.

Command Tree

The Agilent 4287A command tree is shown in the following table.

Command	Parameter	Note
ABORt		[No query]
CALCulate		
:COMParator		
:BEEPer		
:CONDition	{PASS FAIL}	
[:STATe]	{ON OFF 1 0}	
:BIN{1 2 3 4 5 6 7 8 9 10 11 12 13}		
:CONDition{1 2 3 4}		
:LIMit	<numeric>,<numeric>	
:LTYPe	{IN OUT ALL}	
[:STATe]	{ON OFF 1 0}	
:CLEar		[No query]
:CONDition{1 2 3 4}		
:MODE	{ABS DEV PCNT}	
:NOMinal	<numeric>	
:PARAmeter	{Z Y LS LP CS CP RS RP D Q X G B TZR TZD TYR TYD}	
:SNUMber	<numeric>	
:COUNT		
:CLEar		[No query]
[:STATe]	{ON OFF 1 0}	
:DATA		
:BCOU?		[Query only]
:BIN?		[Query only]
:RDC?		[Query only]
:OGBINs	<numeric>	
:RDC		
:LIMit	<numeric>,<numeric>	
[:STATe]	{ON OFF 1 0}	
PARAmeter		
[:MATH]		
:EXAMine		
[:MEMory]		
:START		[No query]
:POINT?	<numeric>	[Query only]
:SAVE		[No query]
PARAmeter{1 2 3 4}		
:FORMat	{Z Y LS LP CS CP RS RP D Q X G B TZR TZD TYR TYD}	
[:MATH]		
:EXAMine		[No query]
:GET?	<numeric>	[Query only]
:LIMit	<numeric>,<numeric>	
:EXPRession		
:CENTer	<numeric>	
:NAME	{DEV PCNT}	
:STATe	{ON OFF 1 0}	

Command	Parameter	Note
DATA		
[:DATA]		
:CAD{1 2 3 4 5 6 7 8}?		[Query only]
:CCO{1 2 3 4 5 6}	<numeric>,...,<numeric>	
:CMD{1 2}?		[Query only]
:CMP{1 2 3}	<numeric>,...,<numeric>	
:FDATa{1 2 3 4}?		[Query only]
:IMON?		[Query only]
:RAW?		[Query only]
:RCAD{1 2 3}?		[Query only]
:RCCO{1 2 3}	<numeric>	
:RCMD{1 2}?		[Query only]
:RCMP{1 2 3}	<numeric>	
:RDC?		[Query only]
:VMON?		[Query only]
DISPlay		
:BACKlight	{ON OFF 1 0}	
:CClear		[No query]
:UPDate	{ON OFF 1 0}	
[:WINDow]		
[:STATe]	{ON OFF 1 0}	
:TEXT1		
:CALCulate{1 2 3 4}		
[:STATe]	{ON OFF 1 0}	
:DIGit	<numeric>	
:FIX	{ON OFF 1 0}	
:MSD	<numeric>	
:CALCulate{11 12}		
[:STATe]	{ON OFF 1 0}	
:DIGit	<numeric>	
:FIX	{ON OFF 1 0}	
:MSD	<numeric>	
:CALCulate13		
:DIGit	<numeric>	
:FIX	{ON OFF 1 0}	
:MSD	<numeric>	
[:STATe]	{ON OFF 1 0}	
:TEXT10		
:DATA	<string>	
[:STATe]	{ON OFF 1 0}	
:TEXT11		
[:STATe]	{ON OFF 1 0}	
:MODE	{STAMP LIVE}	
:TEXT2		
:LABel{1 2 3 4}	{PAR1 PAR2 PAR3 PAR4 VMON IMON FREQ AVER POW RDC}	

GPIB Command Tree
Command Tree

Command	Parameter	Note
FETCh?		[Query only]
FORMat		
:BORDer	{NORMal SWAPped}	
[:DATA]	{ASCIi REAL}	
HCOPy		
:ABORt		[No query]
:CONtent	{SCREen SETup LIST}	
:DPRINter	<numeric>	
:IMAGe	{NORMal INVert MONochrome}	
:PRINters?		[Query only]
[:IMMediate]		[No query]
INITiate		
:CONTinuous	{ON OFF 1 0}	
[:IMMediate]		[No query]
MMEMory		
:CATalog?		[Query only]
:COPI	<string>,<string>	[No query]
:CREate		
:DIRectory	<string>	[No query]
:DELe	<string>	[No query]
:LOAD	<string>	[No query]
:STORe	<string>	[No query]
READ?		[Query only]

Command	Parameter	Note
[SENSe]		
:AVERage		
:COUNT	<numeric>	
:CORRection1		
:CKIT	{DEFault USER}	
:LIST		
[:STATe]	{ON OFF 1 0}	
:STANdard1		
:DC	<numeric>	
:EDELay		
[:TIME]	<numeric>	
:LIST	<numeric>,<numeric>,<numeric>	
:STANdard2		
:DC	<numeric>	
:EDELay		
[:TIME]	<numeric>	
:LIST	<numeric>,<numeric>,<numeric>	
:STANdard3		
:DC	<numeric>	
:EDELay		
[:TIME]	<numeric>	
:FORMat	{RL LQ CDF}	
:LIST	<numeric>,<numeric>,<numeric>	
:COLLect		
[:ACQuire]	{STANdard1 STANdard2 STANdard3 STANdard4}	[No query]
:RF	{STANdard1 STANdard2 STANdard3 STANdard4}	[No query]
:DC	{STANdard1 STANdard2 STANdard3}	[No query]
:SAVE		[No query]
[:STATe]?	{1 0}	[Query only]
:CORRection2		
:CKIT	{DEFault USER}	
:LIST		
[:STATe]	{ON OFF 1 0}	
:STANdard1		
:DC	<numeric>	
:LIST	<numeric>,<numeric>,<numeric>	
:STANdard2		
:DC	<numeric>	
:LIST	<numeric>,<numeric>,<numeric>	
:COLLect		
[:ACQuire]	{STANdard1 STANdard2}	[No query]
:RF	{STANdard1 STANdard2}	[No query]
:DC	{STANdard1 STANdard2}	[No query]
:OPEN		
[:STATe]	{ON OFF 1 0}	
:SAVE		[No query]
:SHORT		
[:STATe]	{ON OFF 1 0}	
:FIXTure	{NONE 16191A 16192A 16193A 16196A 16196B 16196C USER}	
:LABel	<string>	
:EDELay		
:DISTance	<numeric>	

GPIB Command Tree Command Tree

Command	Parameter	Note
SOURce		
:LIST	<numeric>,...,<numeric> (Nop ^{*1} ×3+1 parameters)	
:CLEar		[No query]
:POINt	<numeric>	
:RDC	{ON OFF}1 0}	
:OFSCancel	{ON OFF}1 0}	
:SIZE?		[Query only]
:STATe	{ON OFF}1 0}	
:TABLe	<numeric>	
:UNIT	{DBM V A}	
STATus		
:OPERation		
:CONDition?		[Query only]
:ENABle	<numeric>	
:NTRansition	<numeric>	
:PTRansition	<numeric>	
[:EVENT]?		[Query only]
:PRESet		[No query]
:QUEStionable		
:ENABle	<numeric>	
[:EVENT]?		[Query only]
SYSTem		
:BEEPer1		
[:IMMediate]		[No query]
:STATe	{ON OFF}1 0}	
:BEEPer2		
[:IMMediate]		[No query]
:STATe	{ON OFF}1 0}	
:DATE	<numeric>,<numeric>,<numeric>	
:ERRor?		[Query only]
:ERRor		
:COUNt?		[Query only]
:EXTRef?		[Query only]
:KLOCK		
[:FRONt]	{ON OFF}1 0}	
:KBD	{ON OFF}1 0}	
:MOUSE	{ON OFF}1 0}	
:POFF		[No query]
:PRESet		[No query]
:CONFirm	{ON OFF}1 0}	
:TIME	<numeric>,<numeric>,<numeric>	
:VERSion?		[Query only]
TRIGger		
[:SEQuence1]		
:DELay	<numeric>[MS M S]	
[:IMMediate]		[No query]
:SOURce	{INternal MANual EXTernal BUS}	
:SEQuence2		
:DELay	<numeric>[MS M S]	
:SLOPe	{POSitive NEGative}	

*1. Nop: The number of measurement points defined in the active table.

E 4286A vs. 4287A GPIB Commands Correspondence Table

This appendix gives the correspondence between the Agilent 4287A GPIB commands and those of the Agilent 4286A.

4286A vs. 4287A GPIB Commands Correspondence Table

The table below shows the correspondence between the 4286A and 4287A GPIB commands. For details of each command, refer to the 4286A *Programming Description Manual* and Chapter 15, “Command Reference,” in the 4287A *Programming Description Manual*.

NOTE

There are some cases where the corresponding commands differ in how they are used (e.g., how to supply the parameter(s)). Therefore, it is important to fully understand the details of each command’s function for the particular machine you are using. For example, the measurement parameters setting commands listed in the table are **:CALC:FORM** for the 4286A and **:CALC:PAR{1-4}:FORM** on page 224 for the 4287A, which differ in their use as shown in the example below. **Accordingly, simple command replacement cannot modify a 4286A program into one suitable for the 4287A.**

Example: Setting Ls-Q as the measurement parameter (HP BASIC):

4286A:	10	OUTPUT 717; “:CALC:FORM LSQ”
4287A:	10	OUTPUT 717; “:CALC:PAR1:FORM LS”
	20	OUTPUT 717; “:CALC:PAR2:FORM Q”

4286A vs. 4287A GPIB Commands Correspondence Table
4286A vs. 4287A GPIB Commands Correspondence Table

Function	Item to set/run		GPIB command	
			4286A	4287A
Measurement settings	Reset	Trigger System Consecutive Start Off	*RST	← on page 200
		Trigger System Consecutive Initiation On	:SYST:PRES	← on page 300
	Measurement Parameter Setting		:CALC:FORM	:CALC:PAR{1-4}:FORM on page 224
	Set Measurement Points and Test Signal	Set Test Signal Level	:SOUR:POW :SOUR:CURR :SOUR:VOLT	(Because these differ in how they are used, there is no one-to-one correspondence between the two machines' commands.) :SOUR:LIST on page 288 :SOUR:UNIT on page 292 :SOUR:LIST:CLE on page 289 :SOUR:LIST:STAT on page 291 :SOUR:LIST:POIN on page 289 :SOUR:LIST:TABL on page 291 :AVER:COUN on page 204
		Set List Table	:SENS:LIST:CLE :SENS:LIST:MODIF:SEGM{1-10}:FREQ :SENS:LIST:MODIF:SEGM{1-10}:AVER:COUN :SENS:LIST:SAVE :SENS:LIST:SEGM :SENS:LIST:SEGM:ADD :SENS:LIST:SEGM:AVER:COUN :SENS:LIST:SEGM:DEL :SENS:LIST:SEGM:EDIT :SENS:LIST:SEGM:FREQ :SENS:LIST:SEGM:QUIT :SENS:LIST:SEGM:SAVE	
	Set R _{dc} Measurement	Measurement ON/OFF	:SENS:RDC	:SOUR:LIST:RDC on page 290
		Comparator ON/OFF	:CALC:RDC:LIM:STAT	None. (This is done by turning ON/OFF the entire function of the comparator.)
		Limit Value	:CALC:RDC:LIM:UPP :CALC:RDC:LIM:LOW	:CALC:COMP:RDC:LIM on page 218
	Set Delay Time	Trigger Delay (for each trigger)	:SENS:SWE:DWEL2	:TRIG:DEL on page 302
		Point Delay	:SENS:SWE:DWEL1	:TRIG:SEQ2:DEL on page 303

4286A vs. 4287A GPIB Commands Correspondence Table
4286A vs. 4287A GPIB Commands Correspondence Table

Function	Item to set/run	GPIB command		
		4286A	4287A	
Calibration	Select Calibration Kit	:SENS:CORR1:CKIT	:CORR1:CKIT on page 225	
	Set User Definition Calibration Kit	:SENS:CORR1:CKIT:LAB	None.	
	Save User Definition Calibration Kit	:SENS:CORR1:CKIT:SAVE	None. (Saved with the hardware settings.)	
	Define Each Standard of User Definition Calibration Kit	Select How to Define Impedance Value (for each fixed point and measurement point)	None.	:CORR1:CKIT:LIST on page 226
		Define Open	:SENS:CORR1:CKIT:STAN1:G :SENS:CORR1:CKIT:STAN1:C	:CORR1:CKIT:STAN1:LIST on page 229 :CORR1:CKIT:STAN1:DC on page 227 :CORR1:CKIT:STAN2:LIST on page 232
		Define Short	:SENS:CORR1:CKIT:STAN2:R :SENS:CORR1:CKIT:STAN2:L	:CORR1:CKIT:STAN2:LIST on page 232 :CORR1:CKIT:STAN2:DC on page 230 :CORR1:CKIT:STAN2:EDEL on page 231
		Define Load	:SENS:CORR1:LOAD:TYPE :SENS:CORR1:CKIT:STAN3:R :SENS:CORR1:CKIT:STAN3:L :SENS:CORR1:CKIT:STAN3:Q :SENS:CORR1:CKIT:STAN3:F	:CORR1:CKIT:STAN3:FORM on page 235 :CORR1:CKIT:STAN3:LIST on page 236 :CORR1:CKIT:STAN3:DC on page 233 :CORR1:CKIT:STAN3:EDEL on page 234
	Measure Calibration Coefficient Calculation Data	:SENS:CORR1:COLL	:CORR1:COLL on page 238 :CORR1:COLL:RF on page 240 :CORR1:COLL:DC on page 239	
	Select Measurement Points for Calibration Coefficient Calculation Data	:SENS:CORR1:COLL:FPO	None. (There is no mode for measuring data with fixed measurement points.)	
	Check Calibration Function ON/OFF	:SENS:CORR1?	:CORR1? on page 225	
Calibrate Calibration Coefficient and Turn On Calibration Function	:SENS:CORR1:COLL:SAVE	:CORR1:COLL:SAVE on page 240		
Set Extension of Port	:SENS:CORR1:EDEL:STAT :SENS:CORR1:EDEL	None. (The same function can be implemented with the electrical length setting of fixture selection.)		

4286A vs. 4287A GPIB Commands Correspondence Table
4286A vs. 4287A GPIB Commands Correspondence Table

Function	Item to set/run		GPIB command	
			4286A	4287A
Compensation	Select Compensation Kit		None.	:CORR2:CKIT on page 241
	Set User Definition Compensation Kit Label		:SENS:CORR2:CKIT:LAB	None.
	Save User Definition Compensation Kit		:SENS:CORR2:CKIT:SAVE	None. (Saved with the hardware settings.)
	Define Each Standard of User Definition Compensation Kit	Select How to Define Impedance Value (for each fixed point and measurement point)	None.	:CORR2:CKIT:LIST on page 241
		Define Open	:SENS:CORR2:CKIT:STAN1:G :SENS:CORR2:CKIT:STAN1:C	:CORR2:CKIT:STAN1:LIST on page 243 :CORR2:CKIT:STAN1:DC on page 242
		Define Short	:SENS:CORR2:CKIT:STAN2:R :SENS:CORR2:CKIT:STAN2:L	:CORR2:CKIT:STAN2:LIST on page 245 :CORR2:CKIT:STAN2:DC on page 244
		Define Load	:SENS:CORR2:CKIT:STAN3:R :SENS:CORR2:CKIT:STAN3:L	None. (Cannot perform load compensation.)
	Select Definition Value of User Definition Compensation Kit		:SENS:CORR2:CKIT:STAN1 :SENS:CORR2:CKIT:STAN2 :SENS:CORR2:CKIT:STAN3	None.
	Measure Compensation Coefficient Calculation Data		:SENS:CORR2:COLL	:CORR2:COLL on page 246 :CORR2:COLL:RF on page 248 :CORR2:COLL:DC on page 247
	Select Measurement Points for Calibration Coefficient Calculation Data		:SENS:CORR2:COLL:FPO	None. (There is no mode for measuring data with fixed measurement points.)
	Calculate Compensation Coefficient		:SENS:CORR2:COLL:SAVE	:CORR2:COLL:SAVE on page 249
	Set Open Compensation Function ON/OFF		:SENS:CORR2:OPEN	:CORR2:COLL:OPEN on page 248
	Set Short Compensation Function ON/OFF		:SENS:CORR2:SHOR	:CORR2:COLL:SHOR on page 249
	Set Load Compensation Function ON/OFF		:SENS:CORR2:LOAD	None. (Cannot perform load compensation.)
Fixture Selection	Fixture Selection		:SYST:FIXT	:CORR2:FIXT on page 250
	Set User-created Fixture	Amount Compensated (Electrical Length)	:SYST:FIXT:DIST	:CORR2:FIXT:EDEL:DIST on page 251
		Name	:SYST:FIXT:LAB	:CORR2:FIXT:LAB on page 252
		Save	:SYST:FIXT:SAVE	None. (Saved with the hardware settings.)

4286A vs. 4287A GPIB Commands Correspondence Table
4286A vs. 4287A GPIB Commands Correspondence Table

Function	Item to set/run		GPIB command		
			4286A	4287A	
Comparator (BIN Sort)	ON/OFF Setting		:CALC:COMP:STAT	:CALC:COMP on page 205	
	Read Results of Decision		:DATA? BIN	:CALC:COMP:DATA:BIN? on page 215	
	Set Beep Output Mode		:CALC:BEEP:COND	:CALC:COMP:BEEP:COND on page 205	
	BIN Setting		:CALC:COMP:CLE :CALC:COMP:OFFS :CALC:COMP:SAVE :CALC:COMP:SEGM :CALC:COMP:SEGM:ADD :CALC:COMP:SEGM:DEL :CALC:COMP:SEGM:EDIT :CALC:COMP:SEGM:SAVE :CALC:COMP:SEGM:UPP :CALC:COMP:SEGM:LOW :CALC:COMP:CONT:SEGM :CALC:COMP:SREJ:STAT :CALC:COMP:SREJ:UPP :CALC:COMP:SREJ:LOW	(Because these differ in how they are used, there is no one-to-one correspondence between the two machines' commands.) :CALC:COMP:CLE on page 208 :CALC:COMP:COND{1-4}:SNUM on page 212 :CALC:COMP:COND{1-4}:PAR on page 211 :CALC:COMP:COND{1-4}:MODE on page 209 :CALC:COMP:COND{1-4}:NOM on page 210 :CALC:COMP:BIN{1-13} on page 206 :CALC:COMP:BIN{1-13}:COND{1-4} on page 207 :LIM on page 207 :CALC:COMP:BIN{1-13}:COND{1-4} on page 208 :LTYP on page 208 :CALC:COMP:OGB on page 217	
	BIN Counter	ON/OFF Setting	:CALC:COMP:COUN	←on page 213	
		Count Value	Clear	:CALC:COMP:COUN:CLE	←on page 213
			Read	:DATA? BCOU	:CALC:COMP:DATA:BCOU? on page 214
	R _{dc} Measurement Result Comparator	ON/OFF Setting	:CALC:RDC:LIM:STAT	None. (This is done by turning ON/OFF the entire function of the comparator.)	
		Set Limit Value	:CALC:RDC:LIM:UPP :CALC:RDC:LIM:LOW	:CALC:COMP:RDC:LIM on page 218	
		Read Results of Decision	:DATA? RDCL	:CALC:COMP:DATA:RDC? on page 216	
Limit Test		:CALC:LIM:STAT :CALC:LIM:CLE :CALC:LIM:SAVE :CALC:LIM:SEGM :CALC:LIM:SEGM:ADD :CALC:LIM:SEGM:DEL :CALC:LIM:SEGM:EDIT :CALC:LIM:SEGM:SAVE :CALC:LIM:SEGM:UPP :CALC:LIM:SEGM:LOW :CALC:LIM:SEGM:CONT	None. (The comparator function is used instead.)		

4286A vs. 4287A GPIB Commands Correspondence Table
4286A vs. 4287A GPIB Commands Correspondence Table

Function	Item to set/run		GPIB command	
			4286A	4287A
Trigger	Release Trigger		*TRG	:TRIG on page 302 *TRG on page 202 (with Query response)
	Set Trigger Event Mode		:TRIG:EVEN:TYPE	None.
	Set Trigger Source		:TRIG:SOUR	← on page 304
	Set Polarity of External Trigger		:TRIG:SLOP	← on page 303
	Set Delay Time	Trigger Delay (for each trigger)	:SENS:SWE:DWEL2	:TRIG:DEL on page 302
		Point Delay (for each point)	:SENS:SWE:DWEL1	:TRIG:SEQ2:DEL on page 303
	Trigger System	Reset	:ABOR	← on page 203
		Initiate Once	:INIT	← on page 281
		Reset and then Reinitiate	:INIT:AGA:ALL	None.
		Set Continuous Start ON/OFF	:INIT:CONT	← on page 281
Data Read/Write	Set Data Transfer Format		:FORM	← on page 276
	Set Byte Order for Binary Transfer		None.	:FORM:BORD on page 277
	Read Results of Impedance Measurement (complex number data before calibration/compensation)		:DATA? RAW	:DATA:RAW? on page 258
	Read Results of Impedance Measurement (complex number data after calibration/compensation and before parameter conversion)		:DATA? DATA	None.
	Read Measurement Results of Measurement Parameters		:DATA? DTR	:DATA:FDAT{1-4}? on page 257
	Read Results of R _{dc} Measurement		:DATA? RDC	:DATA:RDC? on page 261
	Read Results of R _{dc} Comparator Decision		:DATA? RDCL	:CALC:COMP:DATA:RDC? on page 216
	Read Results of R _{dc} Comparator Decision, R _{dc} Measurement, and Measurement Parameter		:DATA? RDCDT	None. (The equivalent information can be obtained with :FETC? on page 274 or :READ? on page 287.)
	Read Results of Monitoring Test Signal Level		:DATA? MON	:DATA:IMON? on page 257 :DATA:VMON? on page 261

4286A vs. 4287A GPIB Commands Correspondence Table
4286A vs. 4287A GPIB Commands Correspondence Table

Function	Item to set/run	GPIB command		
		4286A	4287A	
Data Read/Write (continued)	Read/Write Calibration Coefficient	:DATA CCO1{1-3}	:DATA:CCO{1-6} on page 254	
	Read Data for Calibration Coefficient Calculation	None.	:DATA:CAD{1-8}? on page 253	
	Read/Write R _{dc} Measurement Calibration Coefficient	None.	:DATA:RCCO{1-3} on page 259	
	Read Data for R _{dc} Measurement Calibration Coefficient Calibration	None.	:DATA:RCAD{1-3}? on page 259	
	Read/Write Compensation Coefficient	:DATA CMP{1-3}	:DATA:CMP{1-3} on page 256	
	Read Data for Compensation Coefficient Calculation	None.	:DATA:CMD{1-2}? on page 255	
	Read/Write R _{dc} Measurement Compensation Coefficient	None.	:DATA:RCMP{1-3} on page 260	
	Read Data for R _{dc} Measurement Compensation Coefficient Calculation	None.	:DATA:RCMD{1-2}? on page 260	
	Fixture Compensation Standard Array (Standard Value of Compensation Kit)	Read/Write	:DATA:DEF	None.
		Clear	:DATA:DEL	None.
	Read Results of BIN Sort	:DATA? BIN	:CALC:COMP:DATA:BIN? on page 215	
	Read Results of BIN Count	:DATA? BCOU	:CALC:COMP:DATA:BCOU? on page 214	
	Read Sweep Parameter Values of All Measurement Points (Stimulus Array)	:DATA? SPAR	None.	
	Read Results of Limit Test	:DATA? LFA{1-2} :DATA? LLIS{1-2} :DATA? LRES{1-2} :DATA:VAL? LRES{1-2} :DATA:POIN? LFA	None.	

4286A vs. 4287A GPIB Commands Correspondence Table
4286A vs. 4287A GPIB Commands Correspondence Table

Function	Item to set/run		GPIB command	
			4286A	4287A
Status Report Mechanism	Clear Register		*CLS	← on page 198
	Read Status Byte Register Value		*STB?	← on page 201
	Set Service Request Significant Register		*SRE	← on page 201
	Standard Event Status Register	Read Register Value	*ESR?	← on page 199
		Set Significant Register Value	*ESE	← on page 198
		Set OPC Bit Indicated at End of Operation	*OPC	← on page 199
	Hardware Event Status Register	Read Register Value	:STAT:INST?	None. (Of the commands previously assigned to this register, those also required for the 4287A are assigned to other registers that can be used for verification.)
		Set Significant Register Value	:STAT:INST:ENAB	
	Operation Status Register	Reset	:STAT:PRES	← on page 295
		Read Condition Register Value	:STAT:OPER:COND?	← on page 293
		Set Significant Register Value	:STAT:OPER:ENAB	← on page 293
		Read Event Register Value	:STAT:OPER?	← on page 293
		Set Positive Transition Filter Value	:STAT:OPER:PTR	← on page 294
		Set Negative Transition Filter Value	:STAT:OPER:NTR	← on page 294
	Questionable Status Register	Reset	:STAT:PRES	← on page 295
		Set Significant Register Value	:STAT:QUES:ENAB	← on page 295
		Read Event Register Value	:STAT:QUES?	← on page 295

Note: The 4286A and 4287A basically use the same commands for the status report mechanism. However, the structures of the mechanisms are considerably different. For details on this mechanism, refer to the *Programming Description Manual* of the machine you are using.

4286A vs. 4287A GPIB Commands Correspondence Table
4286A vs. 4287A GPIB Commands Correspondence Table

Function	Item to set/run		GPIB command	
			4286A	4287A
Save/Recall	Save/Recall		:MMEM:STOR:CAL:AUTO :MMEM:STOR:DINT:GRAP :MMEM:STOR:DINT:TRAC :MMEM:STOR:ITEM:TRAC:CAT? :MMEM:STOR:ITEM:TRAC:DEL :MMEM:STOR:ITEM:TRAC:SEL :MMEM:STOR:STAT :MMEM:STOR:TRAC :MMEM:LOAD:STAT :MMEM:LOAD:CAL :MMEM:LOAD:TRAC	(Because these differ in how they are used, there is no one-to-one correspondence between the two machines' commands.) :MMEM:STOR on page 285 :MMEM:LOAD on page 284
	File Management	Copy	:MMEM:COPY	←on page 283
		Delete	:MMEM:DEL	←on page 284
		Delete CALREC_C	:MMEM:DEL:CAL	None.
		Creat a new directory	:MMEM:CRE:DIR	←on page 283
		Change current directory	:MMEM:CDIR	None.
		Change file extension	:MMEM:FNAM:EXT{1-2}	None.
		Initialize a strage device	:MMEM:INIT	None.
		Read the information about a storage device	None.	:MMEM:CAT? on page 282
	File Management		:MMEM:CDIR :MMEM:COPY :MMEM:CRE:DIR :MMEM:DEL :MMEM:DEL:CAL :MMEM:FNAM:EXT{1-2} :MMEM:INIT	None. (Cannot be performed with a GPIB command; do this by manually operating the front panel.)
Printer	Items Related to Printer or Plotter Settings		:HCOP:DEF :HCOP:DEV:LANG :HCOP:DEV:SPE :HCOP:ITEM:ANN:STAT :HCOP:ITEM:MENU:STAT :HCOP:ITEM:TDST:STAT :HCOP:PAGE:DIM:FULL :HCOP:PAGE:DIM:QUAD{1-4} :HCOP:PAGE:SCAL	(Because these differ in how they are used, there is no one-to-one correspondence between the two machines' commands.) :HCOP:DPR on page 279 :HCOP:PRIN? on page 280 :HCOP:CONT on page 278 :HCOP:IMAG on page 280
	Output	Run	:HCOP	←on page 278
		Stop	:HCOP:ABOR	←on page 278

4286A vs. 4287A GPIB Commands Correspondence Table
4286A vs. 4287A GPIB Commands Correspondence Table

Function	Item to set/run	GPIB command		
		4286A	4287A	
Display	Display Settings	:DISP:DATA:PARA{1-2} :DISP:DATA:PARA{1-2}:MSD{1-10} :DISP:DATA:PARA{1-2}:MSD:ALL :DISP:DATA:PARA{1-2}:MSD:AUTO :DISP:DATA:PARA{1-2}:MSD:FIX :DISP:ALL :DISP:BCOU:STAT :DISP:TEXT10 :DISP:TEXT{1-10}:PAGE :DISP:TEXT{1-10}:STAT :DISP:TRAC:STAT :CALC:FORM2	(Because these differ in how they are used, there is no one-to-one correspondence between the two machines' commands.) :DISP:BACK on page 262 :DISP on page 262 :DISP:UPD on page 273 :DISP:TEXT1 on page 263 :DISP:TEXT1:CALC{1-4} on page 264 :DISP:TEXT1:CALC{1-4}:DIG on page 264 :DISP:TEXT1:CALC{1-4}:FIX on page 265 :DISP:TEXT1:CALC{1-4}:MSD on page 265 :DISP:TEXT1:CALC{11-12} on page 266 :DISP:TEXT1:CALC{11-12}:DIG on page 266 :DISP:TEXT1:CALC{11-12}:FIX on page 267 :DISP:TEXT1:CALC{11-12}:MSD on page 267 :DISP:TEXT1:CALC13:DIG on page 268 :DISP:TEXT1:CALC13:FIX on page 268 :DISP:TEXT1:CALC13:MSD on page 269 :DISP:TEXT10 on page 270 :DISP:TEXT10:DATA on page 270 :DISP:TEXT11 on page 271 :DISP:TEXT11:MODE on page 271 :DISP:TEXT2:LAB{1-4} on page 272	
Lock I/O Device	Front Panel Key	:SYST:KLOC	← on page 299	
	Keyboard	None.	:SYST:KLOC:KBD on page 299	
	Mouse	None.	:SYST:KLOC:MOUS on page 300	
Beep	Turn ON/OFF Beep Indicating Completion of Operation	:SYST:BEEP1:STAT	← on page 296	
	Beep Indicating Warning or Results of BIN Sort	ON/OFF Setting	:SYST:BEEP2:STAT	← on page 297
		Set Beep Output Mode (OK/NG)	:CALC:BEEP:COND	:CALC:COMP:BEEP:COND on page 205
Built-in Clock	Set Date	:SYST:DATE	← on page 297	
	Set Date Format	:SYST:DATE:MODE	None.	
	Set Time of Day	:SYST:TIME	← on page 301	

4286A vs. 4287A GPIB Commands Correspondence Table
4286A vs. 4287A GPIB Commands Correspondence Table

Function	Item to set/run		GPIB command	
			4286A	4287A
Others	Shutdown		*TST?	←on page 202
	Read Product Information		*IDN?	←on page 199
	Read Error Queue		:SYST:ERR?	←on page 298
	Check Whether External Reference Signal Is Being Input		:DIAG:EREF:STAT?	:SYST:EXTR? on page 298
	Read SCPI Vehicle		:SYST:VERS?	←on page 301
	Read Optional Information		*OPT?	None.
	Waiting for End of Command Run		*WAI	←on page 202
	Read 1 at End of Command Run		*OPC?	←on page 199
	Set OPC Bit at End of Command Run		*OPC	←on page 199
	Set GPIB Address	External Controller	:SYST:COMM:GPIB:CONT:ADDR	None.
		Printer/Plotter	:SYST:COMM:GPIB:RDEV{1-2}:ADDR	None.
	Parallel I/O Port Control		:SYST:COMM:PAR:DATA? :SYST:COMM:PAR:TRAN:DATA	None.
	Set Handler Interface Output Mode		:SYST:COMM:PAR2:MODE	None.
	Send Front Panel Key and Soft Key Codes		:SYST:KEY	None.
	Items Related to IBASIC Control		All commands beginning with :PROG *PCB	None. (IBASIC is not supported.)

F **List of Responses to Measurement Failure**

This appendix summarizes how the Agilent 4287A responds when a measurement fails (an overloading or exceeding the R_{dc} limit range is detected).

Responses to Measurement Failure

When any of the events listed below is detected, the instrument responds by displaying the corresponding notification on the LCD screen, outputting the corresponding data through GPIB, and activating the corresponding handler interface signal, as shown in Table F-1.

- Overload
 (This failure condition is detected when the instrument fails in its ranging performance; for example, when the DUT is detached during measurement.)
- R_{dc} out of range
 (This failure condition is detected when the R_{dc} measurement result falls outside of the limit range.)
- Overload and R_{dc} out of range

Table F-1 List of instrument responses to overload and R_{dc} out of range conditions

	Notification on LCD screen				GPIB output			Activated handler interface signal(s)
	Measurement results			Comparator sorting results	Measurement status	Measured values *1	Comparator sorting results	
	Parameters 1 through 4	Test signal level monitoring	R_{dc}					
Overload*2	9.9E37	9.9E37	Measured values *3	14	1	9.9E37	14	/OVLD
R_{dc} out of range	Measured values *4	Measured values *4	Measured values *5 (highlighted in red)		2	Measured values *6		/RDC_OUT_OF_RANGE
Overload *2 and R_{dc} out of range	9.9E37	9.9E37	Measured values *5 (highlighted in red)		3	9.9E37		/OVLD /RDC_OUT_OF_RANGE

*1. All of the measured values including the measurement results for parameters 1 through 4, test signal level monitoring, and R_{dc} measurement.

*2. In the instrument status area (near the bottom of the screen), an “Ovld” indicator appears in red.

*3. The instrument never detects an overload condition during R_{dc} measurement.

*4. Measured values are displayed as usual, but they can be incorrect due to imperfect contact.

*5. Measured values are displayed as usual, but they are highlighted in red.

*6. Measured values are retrieved as usual, but they can be incorrect due to imperfect contact.

G Initial Settings

This appendix provides initial settings, settings that can be saved/recalled, and settings that can be backed up.

Initial Settings, Settings that can be Saved/Recalled, Settings that can be Backed Up

The following table shows the following items.

- Initial settings (factory settings)
- Settings reset from the GPIB by the :SYST:PRES command on page 300 or the keys on the front panel
- Settings reset from the GPIB by the *RST command on page 200
- Settings that can be saved/recalled

The table uses the following symbols.

○ : Settings that can be saved/recalled

× : Settings that cannot be saved/recalled

- Settings that can be backed up

The table uses the following symbols.

○ : Settings that can be backed up

× : Settings that cannot be backed up

- Available method to set a setting

The table uses the following symbols.

GPIB : Settings that can be set by remote controller using a GPIB command.

Front : Settings that can be set by the front panel keys, the keyboard or the mouse.

Both : Settings that can be set by either of the above methods.

NOTE

The symbol “←” in the table indicates that the value is the same as that indicated to the left.

Initial Settings

Initial Settings, Settings that can be Saved/Recalled, Settings that can be Backed Up

Setting items		Initial settings (factory settings)	Reset		Save/ Recall	Backup	Available method to set	
			:SYST:PRES	*RST				
Measurement parameter	Parameter 1	Z	←	←	○	×	Both	
	Parameter 2	θz (degree)	←	←	○	×	Both	
	Parameter 3	Rs	←	←	○	×	Both	
	Parameter 4	X	←	←	○	×	Both	
List measurement/single-point measurement		Single-point measurement	←	←	○	×	Both	
Measured point number on single-point measurement		1	←	←	○	×	Both	
Active table number		1	←	←	○	×	Both	
Measurement point setup table	Number of measurement points		1	←	←	○	×	Both
	Oscillator	Frequency	1 [MHz]	←	←	○	×	Both
		Level	-13 [dBm]	←	←	○	×	Both
	Averaging factor		1	←	←	○	×	Both
	Unit of oscillator level		dBm	←	←	○	×	Both
R _{dc} measurement	On/Off		Off	←	←	○	×	Both
	Offset cancel function		Off	←	←	×	×	Both
	Limit range	Lower limit value	0 [Ω]	←	←	○	×	Both
		Upper limit value	10 [kΩ]	←	←	○	×	Both
Deviation measurement	On/Off		Off	←	←	○	×	Both
	Mode		DEV	←	←	○	×	Both
	Reference value (center value)		0	←	←	○	×	Both
Delay time	Trigger delay time		0 [s]	←	←	○	×	Both
	Measurement point delay time		0 [s]	←	←	○	×	Both
LCD's backlight On/Off		On	←	←	×	×	Both	
Display On/Off		On	←	←	○	×	Both	
Display's update On/Off		On	←	←	×	×	Both	
Results display (measurement parameters 1 to 4, test signal level monitor, R _{dc} measurement)	All results display On/Off		On	←	←	○	×	Both
	Each result displays On/Off (except R _{dc} measurement result)		On	←	←	○	×	Both
	Number of digits		4	←	←	○	×	Both
	Fixed decimal point mode On/Off		Off	←	←	○	×	Both
	Most significant digit		0	←	←	○	×	Both

Initial Settings

Initial Settings, Settings that can be Saved/Recalled, Settings that can be Backed Up

Setting items		Initial settings (factory settings)	Reset		Save/ Recall	Backup	Available method to set		
			:SYST:PRES	*RST					
Title display	On/Off	Off	←	←	○	×	Both		
	Title characters	“ ” (blank)	←	←	○	×	Both		
Time and date display	On/Off	Off	←	←	○	×	Both		
	Live/Stamp	Stamp	←	←	○	×	Both		
Displayed items on the list measurement display	Item 1 (LABEL-1)	Measurement parameter 1	←	←	○	×	Both		
	Item 2 (LABEL-2)	Measurement parameter 2	←	←	○	×	Both		
	Item 3 (LABEL-3)	Measurement parameter 3	←	←	○	×	Both		
	Item 4 (LABEL-4)	Measurement parameter 4	←	←	○	×	Both		
Trigger source		Internal	←	←	○	×	Both		
Polarity of external trigger		Positive	←	←	○	×	Both		
Trigger system continuous activation On/Off		On	←	Off	×	×	GPIO		
Maximum data size for statistical analysis		3000	←	←	○	×	Both		
Comparator (BIN sort) function On/Off		Off	←	←	○	×	Both		
Boundary between good BIN and no good BIN		10	←	←	○	×	Both		
BIN1 to BIN13 setting	On/Off		Off	←	←	○	×	Both	
	Sorting conditions 1 to 4	Measurement point number	1	←	←	○	×	Both	
		Parameter	Condition 1	Z	←	←	○	×	Both
			Condition 2	θz (degree)	←	←	○	×	Both
			Condition 3	Rs	←	←	○	×	Both
			Condition 4	X	←	←	○	×	Both
		Limit mode (ABS/%/DEV)		ABS	←	←	○	×	Both
		Limit	Nominal value	0	←	←	○	×	Both
			Lower limit value	0	←	←	○	×	Both
	Upper limit value		0	←	←	○	×	Both	
BIN range mode (IN/OUT/ALL)		ALL	←	←	○	×	Both		
BIN count function On/Off		Off	←	←	○	×	GPIO		

Initial Settings, Settings that can be Saved/Recalled, Settings that can be Backed Up

Setting items				Initial settings (factory settings)	Reset		Save/ Recall	Backup	Available method to set	
					:SYST:PRES	*RST				
Calibration option of 'Calibration Wizard' (calibration only /calibration and compensation)				Calibration and Compensation	No effect	←	×	○	Front	
Setting of 'Calibration Wizard'	Calibration			Low-Loss C	Check	No effect	←	×	○	Front
				DC Open	No check	No effect	←	×	○	Front
				DC Short	No check	No effect	←	×	○	Front
				DC Load	No check	No effect	←	×	○	Front
	Compensation			Open	Check	No effect	←	×	○	Front
				Short	Check	No effect	←	×	○	Front
				DC Open	No check	No effect	←	×	○	Front
				DC Short	No check	No effect	←	×	○	Front
	Target table on measurement of data (All tables/Active table only)				Active table only	No effect	←	×	○	Front
	Automatically saves the state into auto-recall file (autorec.sta) when the 'Calibration Wizard' is completed				No check	No effect	←	×	○	Front
	R _{dc} check at measurement of each standard	On/Off			Off (No check)	No effect	←	×	○	Front
		Limit	Calibration	Short-Load	25 [Ω]	No effect	←	×	○	Front
Load-Open				100 [Ω]	No effect	←	×	○	Front	
		Compensation	Short-Open	50 [Ω]	No effect	←	×	○	Front	

Initial Settings

Initial Settings, Settings that can be Saved/Recalled, Settings that can be Backed Up

Setting items		Initial settings (factory settings)	Reset		Save/ Recall	Backup	Available method to set	
			:SYST:PRES	*RST				
Target table in measurement of data for calibration coefficient calculation (all tables/active table only) *1		Active table only	No effect	←	×	○	Front	
Automatically saves the state into auto-recall file (autorec.sta) when the calibration coefficients are calculated *2		No check	No effect	←	×	○	Both	
Calibration kit selection (7 mm standard/user defined)		7 mm standard	←	←	○	×	Both	
User defined calibration kit	Impedance definition method (fixed/point-by-point)	Fixed	←	←	○	×	Both	
	Open	Equivalent parallel conductance (G)	0 [S]	←	←	○	×	Both
		Equivalent parallel capacitance (Cp)	0 [F]	←	←	○	×	Both
		Dc conductance	0 [S]	←	←	○	×	Both
		Offset delay time	0 [s]	←	←	○	×	Both
	Short	Equivalent series resistance (Rs)	0 [Ω]	←	←	○	×	Both
		Equivalent series inductance (Ls)	0 [H]	←	←	○	×	Both
		Dc resistance	0 [Ω]	←	←	○	×	Both
		Offset delay time	0 [s]	←	←	○	×	Both
	Load	Definition impedance parameter type	Rs and Ls	←	←	○	×	Both
		Equivalent series resistance (Rs)	50 [Ω]	←	←	○	×	Both
		Equivalent series inductance (Ls)	0 [H]	←	←	○	×	Both
		Dc resistance	50 [Ω]	←	←	○	×	Both
		Offset delay time	0 [s]	←	←	○	×	Both

*1. When data measurement is performed by GPIB command, the target table is always 'active table only' regardless of this setting.

*2. When calculation of the calibration coefficients is performed by GPIB command, the state is not saved into auto-recall file (autorec.sta) regardless of this setting.

Initial Settings

Initial Settings, Settings that can be Saved/Recalled, Settings that can be Backed Up

Setting items		Initial settings (factory settings)	Reset		Save/ Recall	Backup	Available method to set	
			:SYST:PRES	*RST				
Open compensation On/Off		Off	←	←	○	×	Both	
Short compensation On/Off		Off	←	←	○	×	Both	
Target table in measurement of data for compensation coefficient calculation (all tables/active table only)*1		Active table only	No effect	←	×	○	Front	
Automatically saves the state into auto-recall file (autorec.sta) when the compensation coefficients are calculated*2		No check	No effect	←	×	○	Both	
Selection of compensation kit definition values (predefined values/user defined values)		Predefined values (default)	←	←	○	×	Both	
User defined values	Impedance definition method (fixed/point-by-point)		Fixed	←	←	○	×	Both
	Open	Equivalent parallel conductance (G)	0 [S]	←	←	○	×	Both
		Equivalent parallel capacitance (Cp)	0 [F]	←	←	○	×	Both
		Dc conductance	0 [S]	←	←	○	×	Both
	Short	Equivalent series resistance (Rs)	0 [Ω]	←	←	○	×	Both
		Equivalent series inductance (Ls)	0 [H]	←	←	○	×	Both
		Dc resistance	0 [Ω]	←	←	○	×	Both
Test fixture selection		None	←	←	○	×	Both	
User fixture	Electrical length	0 [m]	←	←	○	×	Both	
	Name	“USER”	←	←	○	×	Both	

Initial Settings

Initial Settings, Settings that can be Saved/Recalled, Settings that can be Backed Up

Setting items		Initial settings (factory settings)	Reset		Save/ Recall	Backup	Available method to set
			:SYST:PRES	*RST			
Data transfer format	Data transfer format (ASCII/Binary)	ASCII	No effect	ASCII	×	×	GPIB
	Byte order when data transfer format is set to binary (normal/swapped)	Normal	No effect	Normal	×	×	GPIB
Printer	Printer selection	HP DeskJet 970C Series	No effect	←	×	○	Both
	Content	Screen graphics	←	←	○	×	Both
	Color	Normal	←	←	○	×	Both
	Orientation	Portrait	←	←	○	×	Front
Key lock	Front panel	Off	←	←	×	×	Both
	Keyboard	Off	No effect	←	×	×	Both
	Mouse	Off	←	←	×	×	Both
Beeper	On/Off of beep to notify the completion of operation	On	←	←	○	×	Both
	Beep to notify an error/warning or sorting results	On/Off	←	←	○	×	Both
		Mode	FAIL	←	←	○	×
Time and date of the internal clock		—	No effect	←	×	○	Both
GPIB address		17	No effect	←	×	○	Front
IP address		192.168.0.1	No effect	←	×	○	Front
Gateway IP address		192.168.0.1	No effect	←	×	○	Front
Subnet mask		255.255.255.0	No effect	←	×	○	Front
Computer name		4287A	No effect	←	×	○	Front
Enable/Disable setting of network device		Disable	No effect	←	×	○	Front
Service request enable register value		0	No effect	←	×	×	GPIB
Standard event status enable register value		0	No effect	←	×	×	GPIB
Operation status register	Enable register value	0	No effect	←	×	×	GPIB
	Positive transition filter value	32767	No effect	←	×	×	GPIB
	Negative transition filter value	0	No effect	←	×	×	GPIB
Questionable status enable register value		0	No effect	←	×	×	GPIB

H Using Printer

This chapter explains how to use a printer to produce hard copies of your measurement results and images displayed on the LCD screen.

Printer Support

NOTE

The printing function is not supported at present. This section explains function for the older version of 4287A specified with the serial numbers as below and is not applicable for the newer version

Table H-1 Compatible printers (as of January 2000)

Version	Serial number	Printing fuction
Older	JP1KG00xxx MY43200xxx	Yes
Newer	MY43300xxx	No

Preparation for Printing

Checking supported printers

To check printers supported by the 4287A, use the following command:

- :HCOP:PRIN? on page 280

Selecting a printer

To select the printer you want to connect to the 4287A, use the following command:

- :HCOP:DPR on page 279

Executing this command configures the 4287A to use your selected printer. Once you have selected the printer, the printer settings are stored in the non-volatile memory, and you do not have to issue the command again unless you use another printer.

NOTE

After you have reconfigured the instrument to use another printer, it may take several seconds for the instrument to update its internal settings. This means that you should not immediately follow this command with another; allow at least 10 seconds before issuing another command.

Outputting the Data to the Printer

Selecting what to output

You can output the following types of data to the printer:

Type of data	Description
Images on the LCD screen	You can print bitmap images*1 from the non-volatile memory (clipboard). If no image resides on the clipboard, the image currently displayed on the screen is transferred to the clipboard before it is output to the printer. When you are working with the measurement results for single-point measurement, you can choose this item to output the data as an image. You can select one of the available color schemes.
Setup Table	Instructs the instrument to output the active table contents, which can contain a measurement point setup table, calibration kit setup table, compensation kit setup table, and BIN sorting setup table. (Monochrome only)
Results of list measurement	Instructs the instrument to output the measurement results of list measurement across all of the measurement points. You cannot output this data when you are working with the results of single-point measurement. (Monochrome only)

*1. This is the image displayed before you pressed the **[Capture]** key (**[Display]** key).

To make this selection, use the following command:

- :HCOP:CONT on page 278

Selecting the color scheme

When you print out the image on the LCD screen, you can choose one of the following three color schemes:

Color scheme	Description
Color	Produces a hard copy with colors that approximate those on the screen.
Color (inverse)	Produces a hard copy with colors inverse to those on screen: black for white, white for black, blue for yellow, yellow for blue, red for light blue, and light blue for red.
Monochrome (inverse)	Produces a monochrome hard copy with gray scales inverse to those on screen.

To make this selection, use the following command:

- :HCOP:IMAG on page 280

Starting a print operation

To actually send the data to the printer, use the following command:

- :HCOP on page 278

Canceling the print operating

To cancel the print operation, use the following command:

- :HCOP:ABOR on page 278

Sample Program

Example H-1 shows a sample program that demonstrates how to print out data. You can find the source file of this program, named `printer.bas`, on the sample program disk.

This sample program lets the user select a printer and outputs the specified type of data to the printer.

The program is described in detail below:

Line 40	Sets the GPIB address.
Lines 60 to 80	Retrieves and displays the currently selected printer.
Lines 90 to 100	Prompts the user to confirm whether to use another printer and waits until the user presses the y or n key.
Lines 110 to 140	If the user presses the y key in response to line 100, the program passes control to a subprogram named <code>Printer_select</code> to change the printer setting.
Lines 160 to 170	Retrieves the list (1)/single-point (0) measurement setting and stores the setting into the <code>List_stat</code> variables.
Line 190	Allows the user to return to the entry start line and re-enter the data if an error (such as an invalid entry) occurs while entering the number that identifies the type of data to print out.
Lines 210 to 330	Displays the list of items that can be printed and prompts the user to choose one of the items by typing in the appropriate number.
Line 340	Converts the entered value into an integer and stores it into the <code>Content</code> variable.
Line 350	If <code>Content</code> is not within the range between 1 and 3 (for list measurement) or the range between 1 and 2 (for single-point measurement), the program returns the user to the entry start line.
Lines 370 to 450	Determines what to print out based on <code>Content</code> . If <code>Content</code> is 1 (i.e., the user chooses to print the image on the LCD screen), the program sets the color scheme to monochrome.
Line 470	Begins sending the data to the printer.

The `Printer_select` subprogram in lines 540 to 1030, which allows the user to select another printer, is described below.

Lines 580 to 590	Retrieves the information on supported printers and stores the information into the <code>Info\$</code> variable.
Lines 610 to 690	Extracts the printer information from the <code>Info\$</code> variable and stores the information into the <code>Prin_info\$(*)</code> array. Note that the printer information includes the number of supported printers and the specifics to the respective printers and is delimited with <code><newline></code> characters (ASCII code 10).
Line 710	Stores the number of supported printers into the <code>Printers</code> variable.
Lines 720 to 840	Extracts the printer number and name from the information specific to each supported printer and stores the printer number into the

Using Printer Sample Program

- Print_no(*) array and the printer name into the Printer\$(*) array.
- Lines 860 to 970 Displays the list of supported printers and prompts the user to choose one of the items by typing in the appropriate number. Then the program converts the entered value into an integer and stores it into the Select_pr variable.
- Lines 990 to 1020 Issues the printer selection command and then retrieves and displays the selected printer.

Example H-1

Printer (printer.bas)

```
10 DIM Set_pr$(50),Inp_char$(9)
20 INTEGER List_stat,Max_no,Content
30 CLEAR SCREEN
40 ASSIGN @Agt4287a TO 717
50 !
60 OUTPUT @Agt4287a;":HCOP:DPR?"
70 ENTER @Agt4287a;Set_pr$
80 PRINT "Current Printer Selection: "&Set_pr$
90 PRINT "Do you want to change the printer selection?"
100 INPUT "[Y]es/[N]o",Inp_char$
110 IF UPC$(Inp_char$)="Y" OR UPC$(Inp_char$)="YES" THEN
120 PRINT "## Printer Selection ##"
130 Printer_select(@Agt4287a)
140 END IF
150 !
160 OUTPUT @Agt4287a;":SOUR:LIST:STAT?"
170 ENTER @Agt4287a;List_stat
180 !
190 ON ERROR GOTO Content_select
200 Content_select: !
210 PRINT "## Print Content Selection ##"
220 PRINT "Select Content"
230 PRINT " 1: Screen"
240 PRINT " 2: Setup Tables (Stimulus,Cal Kit,Compen Kit,Bin Sort)"
250 IF List_stat=1 THEN
260 PRINT " 3: List Measurement Result"
270 Max_no=3
280 ELSE
290 Max_no=2
300 END IF
310 PRINT ""
320 PRINT "Input 1 to "&VAL$(Max_no)
330 INPUT "Number?",Inp_char$
340 Content=IVAL(Inp_char$,10)
350 IF Content<1 OR Content>Max_no THEN Content_select
360 OFF ERROR
370 SELECT Content
380 CASE 1
390 OUTPUT @Agt4287a;":HCOP:CONT SCR"
400 OUTPUT @Agt4287a;":HCOP:IMAG MON"
410 CASE 2
420 OUTPUT @Agt4287a;":HCOP:CONT SET"
430 CASE 3
440 OUTPUT @Agt4287a;":HCOP:CONT LIST"
450 END SELECT
460 !
470 OUTPUT @Agt4287a;":HCOP"
480 !
490 PRINT "Program finished."
500 END
510 !=====
```

```

520 ! Printer Selection Function
530 !=====
540 SUB Printer_select(@Agt4287a)
550 DIM Info$(500),Prin_info$(0:20)[50],Printer$(1:20)[50],
Set_pr$(50)
560 INTEGER Info_len,Loc,N,Prin_no(1:20)
570 !
580 OUTPUT @Agt4287a;" :HCOP:PRIN?"
590 ENTER @Agt4287a USING "-K";Info$
600 Info_len=LEN(Info$)
610 Loc=2
620 N=0
630 FOR I=2 TO Info_len-1
640 IF Info$(I;1)=CHR$(10) THEN
650 Prin_info$(N)=Info$(Loc,I-1)
660 Loc=I+1
670 N=N+1
680 END IF
690 NEXT I
700 !
710 Printers=IVAL(Prin_info$(0),10)
720 FOR I=1 TO Printers
730 IF Prin_info$(I)[1;1]=", " THEN
740 Prin_info$(I)=Prin_info$(I)[2,Info_len]
750 END IF
760 Info_len=LEN(Prin_info$(I))
770 FOR J=1 TO Info_len
780 IF Prin_info$(I)[J;1]=", " THEN
790 Printer$(I)=Prin_info$(I)[J+1,Info_len]
800 Prin_no(I)=IVAL(Prin_info$(I)[1,J-1],10)
810 J=Info_len
820 END IF
830 NEXT J
840 NEXT I
850 !
860 ON ERROR GOTO Printer_select
870 Printer_select: !
880 PRINT "Select Printer"
890 FOR I=1 TO Printers
900 PRINT USING "2D,2A,40A";Prin_no(I)," : ",Printer$(I)
910 NEXT I
920 PRINT ""
930 PRINT "Input 1 to "&VAL$(Prin_no(Printers))
940 INPUT "Printer No?",Inp_char$
950 Select_pr=IVAL(Inp_char$,10)
960 IF Select_pr<1 OR Select_pr>MAX(Prin_no(*)) THEN Printer_select
970 OFF ERROR
980 !
990 OUTPUT @Agt4287a;" :HCOP:DPR ";Select_pr
1000 OUTPUT @Agt4287a;" :HCOP:DPR?"
1010 ENTER @Agt4287a;Set_pr$
1020 PRINT "Current Printer Selection: "&Set_pr$
1030 SUBEND

```

Using Printer
Sample Program

I Error messages

The Agilent 4287A provides error messages to indicate its operating status. This appendix describes the error messages of the 4287A in order of error number. To search error messages alphabetically, refer to the *Operation Manual*.

Error messages

Error number: No number

Error messages are displayed at the top of the 4287A's LCD. Error messages generated during the execution of a GPIB command are preceded by the string "[GPIB]" or "[TELNET]" and can be read out using the GPIB command. This section describes each error message and its remedy.

You can clear error messages displayed on the screen using the following commands.

- :DISP:CCL on page 263

NOTE

Errors with a negative error number are basically general errors defined by IEEE488.2 for GPIB instruments. On the other hand, errors with a positive error number are defined specifically for the 4287A.

Order of error number

No number

A21 board can't be detected. The instrument will be automatically shutdown in 20 seconds.

The A21 board cannot be detected.

The 4287A will be automatically shut down in approximately 20 seconds after the occurrence of this error. The 4287A is at fault and needs repair.

Contact the Agilent Technologies sales office or the company you purchased this instrument.

NOTE

This is a special error that occurs at the startup of the 4287A. The error message, unlike other ones, is displayed in the box that appears at the center of the LCD display, instead of the top of it. No error number is assigned.

No number

A24 GPIB board can't detected. Press OK to continue.

The A24 board cannot be detected.

Although the measurement screen appears normally, the instrument has started up abnormally (GPIB is disabled). To recover the normal status, reboot the 4287A (turn OFF the standby switch and then ON again).

If this error persists after rebooting the 4287A, or occurs frequently, the 4287A is at fault and needs repair. Contact the Agilent Technologies sales office or the company you purchased this instrument.

NOTE

This is a special error that occurs at the startup of the 4287A. The error message, unlike other ones, is displayed in the box that appears at the center of the LCD display, instead of the top of it. No error number is assigned.

- 0 **(No error)**
No error has occurred.
This message is not displayed on the LCD. 0 is returned as the error number if no error has occurred in the instrument when the :SYST:ERR? command on page 298 is sent through GPIB.
- 6 **Additional standards needed**
Before the completion of all data measurements required for calculating the calibration/compensation coefficients, a GPIB command requiring some part of the measurement data is sent. For example, when only the OPEN and SHORT measurements of the calibration kit have been complete, the :CORR1:COLL:SAVE command on page 240, which performs calculation of the calibration coefficients, is sent.
Measure all of the required data.
- 7 **Calibration required**
Although the calibration is not turned on, a GPIB command is sent that is valid only when the calibration is turned on. For example, the :CORR2:COLL command on page 246, which obtains the data for calculating the compensation coefficients, is executed.
Turn on the calibration.
- 11 **Compensation required**
Although compensation is not turned on, a GPIB command is sent that is valid only when compensation is turned on. For example, the :DATA:CMP{1-3} command on page 256, which reads out the compensation coefficients, is executed when compensation is turned off.
Turn on the compensation.
- 22 **Printer error**
The printer does not respond to control from the 4287A.
Check the power to the printer, cable connections, paper, and so on.
- 61 **No data available on memory**
Although the data for statistical analysis has not been acquired, the :CALC:EXAM:GET? command on page 219, which executes statistical analysis and acquires the results, is sent.
Acquire the data for statistical analysis.
- 62 **Can't execute data examination**
The data for statistical analysis has been acquired, but change is made to the settings during data acquisition, and thus statistical analysis cannot be executed.
Acquire the data for statistical analysis with the current settings.

104

Save error

When saving a file, anomalies in the storage media are detected. For example, when you attempt to save a file on a floppy disk, there is not enough space on the disk.

Make sure there is enough space on the floppy disk.

105

Recall error

An error occurs while reading out (recalling) a file. For example, you attempt to read out a file with invalid contents (such as an instrument setting file with extension “.sta”, which is saved by using an instrument other than the 4287A).

Make sure that the contents of the file are valid.

106

Invalid File Name

When executing the save/recall file command, a file name string is invalid. For example, when executing the save command, no extension for the file is specified.

Specify a valid file name.

This error also occurs if the floppy disk has not been correctly set into the drive or if the disk is write-protected when you attempt to save a file onto the disk.

120

PLL unlock

Phase lock loop is not locked

When you enter the external reference signal, check to make sure it is correct. If you entered the correct signal or you did not enter any signal, the instrument needs adjustment or repair. Contact your local Agilent Technologies sales office or the company you purchased this instrument from.

198

Power on test failed

In the power-on self test, a fault is detected.

Contact your local Agilent Technologies sales office or the company you purchased this instrument from.

- 100 **Command error**
A comprehensive syntax error occurs for which the 4287A cannot detect further details of the error. This error code simply indicates the occurrence of a command error that is defined in IEEE488.2,11.5.1.1.4.
- 101 **Invalid character**
Invalid characters exist in the program message string. For example, in a correct program message “:CALC:PAR1:FORM LS”, an ampersand (&) is inserted by mistake to give “:CALC:PAR1:FORM&LS”.
- 102 **Syntax error**
There is a command or data type that cannot be recognized. For example, in a correct program message “:SYST:PRES”, a colon (:) is inserted by mistake to give “:SYST::PRES”.
- 103 **Invalid separator**
The parser (syntax analysis program) expects a separator, but a character other than a separator is sent. For example, although the correct way is to use “;” to separate two sent program messages such as “:CALC:PAR1:FORM LS;*OPC?”, the semicolon (;) needed to separate the program messages is missing to give “:CALC:PAR1:FORM LS *OPC?”.
- 104 **Data type error**
The parser recognized impossible data elements. For example, numeric value or string data is expected, but block data is sent.
- 105 **GET not allowed**
A group execution trigger (GET) is received in a program message. (Refer to IEEE488.2,7.7.)
- 108 **Parameter not allowed**
The number of parameters is larger than required by the command. For example, although the :SOUR:LIST:TABL command on page 291 requires one parameter such as “:SOUR:LIST:TABL 3”, two parameters are added to give “:SOUR:LIST:TABL 3,5”.
- 109 **Missing parameter**
The number of parameters is less than required by the command. For example, although the :SOUR:LIST:TABL command on page 291 requires one parameter such as “:SOUR:LIST:TABL 3”, no parameter is added to give “:SOUR:LIST:TABL”.
- 112 **Program mnemonic too long**
The length of the header exceeds 12 characters. (Refer to IEEE488.2,7.6.1.4.1.)
- 113 **Undefined header**
A header not defined for the 4287A is received. For example, “*XYZ”, which is not defined for the 4287A, is received.
- 120 **Numeric data error**
Numeric data (including numeric data without a decimal point) causes an error. A numeric value error other than -121 to -129 occurs.

Error messages

Error number: -121

- 121 **Invalid character in number**
An invalid character for the data type of the syntax analysis target is received. For example, alphabetical characters exist in a decimal value or “9” exists in octal data.
- 123 **Exponent too large**
The absolute value of the exponent exceeds 32,000. (Refer to IEEE488.2,7.7.2.4.1.)
- 124 **Too many digits**
The number of digits of the mantissa of the decimal value data element exceeds 255 except for preceding 0s. (Refer to IEEE488.2,7.7.2.4.1.)
- 128 **Numeric data not allowed**
A numeric value data element (that does not violate the standard) is received where the 4287A does not accept any numeric value data element.
- 131 **Invalid suffix**
The suffix does not meet the syntax defined in IEEE488.2,7.7.3.2 or is inappropriate for the 4287A.
- 134 **Suffix too long**
The suffix contains notation of 12 characters or more. (Refer to IEEE488.2,7.7.3.4.)
- 138 **Suffix not allowed**
A suffix is added to a numeric value element that does not permit a suffix.
- 148 **Character data not allowed**
A character data element (that does not violate the standard) is received where the 4287A does not accept any character data element.
- 150 **String data error**
An error not included in error numbers between -151 and -159 occurs during the syntax analysis of a string data element.
- 151 **Invalid string data**
Character string data are expected, but the string data received are invalid for some reason. (Refer to IEEE488.2,7.7.5.2.) For example, the END message is received before the end quotation mark character appears.
- 158 **String data not allowed**
A string data element is received where the 4287A does not accept any string data element. For example, a parameter must be enclosed with double quotation marks (“...”) but they are missing.
- 161 **Invalid block data**
Block data are expected, but the block data received are invalid for some reason. (Refer to IEEE488.2,7.7.6.2.) For example, the END message is received before the length of the block data is reached.
- 168 **Block data not allowed**
A block data element is received where the 4287A does not accept any block data element.

- 170 **Expression error**
An error not included in error numbers between -171 and -179 occurs during the syntax analysis of equation data.
- 171 **Invalid expression**
The equation data element is invalid. (Refer to IEEE488.2,7.7.7.2.) For example, parentheses are not paired or a character violates the standard.
- 178 **Expression data not allowed**
An equation data element is received where the 4287A does not accept any equation data element.
- 200 **Execution error**
A comprehensive execution error occurs for which the 4287A cannot detect further details of the error. This error code simply indicates the occurrence of an execution error that is defined in IEEE488.2,11.5.1.1.5.
- 211 **Trigger ignored**
A trigger command or trigger signal is received and recognized by the 4287A, but it is ignored due to the timing relationship with the 4287A. For example, this happens when the 4287A's trigger system is not in the Waiting for Trigger state).
- 213 **Init ignored**
Another measurement is being executed and the measurement start request (:INIT command on page 281) is ignored.
- 221 **Setting conflict**
A program data element complying with the syntax standard is analyzed, but the 4287A cannot execute it at present.
- 222 **Data out of range**
A data element (that does not violate the standard) is received out of the range defined for the 4287A.
- 223 **Too much data**
The received block, equation, or string type program data complies with the standard but the amount of data exceeds the limit that the 4287A can handle due to memory or device-specific conditions related to memory.
- 224 **Illegal parameter value**
The value of the parameter is not allowed.
- 230 **Data corrupt or stale**
The data is invalid or a newly initiated read operation has not been completed since the latest access.
- 256 **File name not found**
The specified filename is not found and, as a result, the command is not executed correctly. For example, this happens when you attempt to read a file that does not exist on the disk.

This message is also displayed when you attempt to read a file on floppy disk drive, but no floppy disk is correctly inserted in the drive.

Error messages

Error number: -310

-310

System error

One of the “system errors” defined for the 4287A occurs.

-321

Out of memory

An internal operation needed more memory than is available.

-400

Query error

A comprehensive Query error occurs for which the 4287A cannot detect further details. This code simply indicates the occurrence of a Query error that is defined in IEEE488.2,11.5.1.1.7 and 6.3.

-410

Query INTERRUPTED

This indicates the status that causes an “INTERRUPTED” Query error. (Refer to IEEE488.1,6.3.2.3.) This error occurs, for example, when data byte (DAB) or GET is received after Query but before the response has been completely sent.

-420

Query UNTERMINATED

This indicates the status that causes an “UNTERMINATED” Query error. (Refer to IEEE488.2,6.3.2.) This error occurs, for example, when the 4287A is specified as a talker and an incomplete program message is received.

-430

Query DEADLOCKED

This indicates the status that causes a “DEADLOCKED” Query error. (Refer to IEEE488.2,6.3.1.7.) This error occurs, for example, when both input and output buffers become full and the 4287A cannot continue processing.

-440

Query UNTERMINATED after indefinite response

In a certain program message, after a Query that requests an ambiguous response is executed, another Query is received. (Refer to IEEE488.2,6.5.7.5.7.)

Symbols

"Change 3" on page 305, 308
 0, 26
 σ , 119
 .bmp, 126
 .csv, 126
 .dta, 126
 .sta, 126
 |Y|, 26
 |Z|, 26

Numerics

1 point measurement, 28
 4286A vs. 4287A GPIB Commands Correspondence Table,
 337
 4287A IP address setting, 159
 7 mm calibration kit, 38
 9.9E37, 350

A

A23 handler interface board, 151
 Abort, 362
 Absolute mode, 107
 Active table, 27
 Address
 GPIB
 Factory setting, 358
 How to set, 21
 IP
 Factory setting, 358
 How to set, 159
 Additional standards needed
 EG&A, 368
 Application program, 167
 Array components measurement, 186
 ASCII format, 75
 Auto recall, 127
 autorec.sta, 127
 Average(Mean) value, 119
 Averaging factor
 For impedance measurement, 27
 For Rdc measurement, 305

B

B, 26
 Backed up, 352
 Backlight on/off, 31
 Bad bin, 107
 Beep
 Condition, 106, 205
 Generate, 296
 On/off, 296, 297
 Bin count function, 111
 BIN range mode, 107
 Bin sort
 On/off, 106

Setting the beep condition, 106
 Setting the sorting conditions, 106
 Sort results
 Handler output, 144
 bin_sort.bas, 114
 Binary format
 Byte order, 76
 Format, 76
 Sample program, 89
 bmp, 126
 Bus trigger, 67
 Byte order, 76

C

calib.bas, 46
 Calibration Coefficient Array, 80
 Calibration coefficients
 Calculating, 38, 39
 Retrieving and writing, 41
 Calibration Data Array, 80
 Calibration kit, 38
 Print, 362
 Cancel, 362
 Checking the number of measurement points, 27
 Clear
 Bin count, 111
 Bin sort(Comparator) setup table, 106
 Error message, 368
 Error queue, 198
 Measurement point(Stimulus) setup table, 27
 Status register, 198, 295
 Clock
 Display on/off, 31
 Set
 Date, 297
 Time, 301
 Color, 362
 Command Reference
 4287A commands, 203
 Convents, 196
 IEEE Common Commands, 198
 Commands Correspondence Table
 4286A vs. 4287A GPIB Commands Correspondence Table,
 337
 Comparator
 On/off, 106
 Retrieving Rdc limit test results, 101
 Setting the beep condition, 106
 Setting the sorting conditions, 106
 Sort results
 Handler output, 144
 Sorting results
 Retrieving, 110
 Comparator results, 110
 Compatible Printers, 360
 compen.bas, 60
 Compensation Coefficient Array, 81

- Compensation coefficients
 - Calculating, 54
 - Retrieving and writing, 55
 - Compensation Data Array, 81
 - Compensation kit, 52
 - Print, 362
 - Computer name, 160
 - Condition register, 314
 - Contact failure, 350
 - Content, 362
 - Control by telnet, 164
 - Copyright, 2
 - Cp, 26
 - Cs, 26
 - csv, 126
 - Current level
 - Retrieving monitored values, 99
 - Setting, 27
 - Current/voltage monitor array, 82
 - Customizing the display, 29
- D**
- D, 26
 - Data array, 79
 - Data flow, 77
 - Data for calculating the calibration coefficients
 - Measurement, 38
 - Retrieving, 40
 - Data for calculating the compensation coefficients
 - Measurement, 52
 - Retrieving, 54
 - Data transfer format, 74
 - data.bas, 95
 - Date
 - display on/off, 31
 - Set, 297
 - Dc resistance measurement
 - Limit setting, 28
 - Offset cancel function, 28
 - On/off setting, 28
 - Decimal point, 30
 - Default printer, 361
 - Default values, 352
 - Delay time
 - Measurement point delay time, 303
 - Trigger delay time, 302
 - Deviation measurement mode, 29
 - Deviation tolerance mode, 107
 - Digits, 30
 - Display
 - On/off, 31
 - Update, 31
 - Display Data Array, 79
 - Display of measurement results
 - Customizing the display, 29
 - On/off setting, 30
 - Setting the decimal point, 30
 - Setting the number of digits, 30
 - Drive voltage, 150
 - dta, 126
- E**
- Electrical length, 51
 - Enable register, 313
 - Error message
 - Clear, 368
 - How to read, 134
 - List, 368
 - Error queue, 134
 - Event register, 313
 - Example, 167
 - Ext Ref In connector, 298
 - Extension, 126
 - External trigger, 67
 - polarity, 303
- F**
- Factory settings, 352
 - Failure, 350
 - fetch.bas, 92
 - File, 126
 - File transfer, 161
 - file_sav.bas, 129
 - filelist.bas, 132
 - Firmware version, 199, 308
 - Fixed decimal point, 30
 - Fixture selection, 51
 - Flow
 - Data flow, 77
 - Sorting flow, 109
 - Frequency, 27
 - Frequency distribution, 119
 - ftp, 161
 - FTP(file transfer protocol), 161
- G**
- G, 26
 - Gateway IP address, 159
 - Good bin, 107
 - GPIB address
 - Factory setting, 358
 - How to set, 21
 - GPIB command
 - :MMEM:CATalog?, 282
 - :MMEM:COpy, 283
 - :MMEM:CREate
 - DIRectory, 283
 - :MMEM:DELeTe, 284
 - [:SENSe]:AVERAge:COUNT, 204
 - GPIB Command Reference
 - 4287A commands, 203
 - Convents, 196
 - IEEE Common Commands, 198

 GPIB commands

*CLS, 198
 *ESE, 198
 *ESR?, 199
 *IDN?, 199
 *OPC, 199
 *OPC?, 199
 *RST, 200
 *SRE, 201
 *STB?, 201
 *TRG, 202
 *TST?, 202
 *WAI, 202
 :ABORt, 203
 :CALCulate:COMParator:BEEPer:CONDition, 205
 :CALCulate:COMParator:BIN{1-13}:CONDition{1-4}:LIMit, 207
 :CALCulate:COMParator:BIN{1-13}:CONDition{1-4}:LTYPe, 208
 :CALCulate:COMParator:BIN{1-13}[:STATe], 206
 :CALCulate:COMParator:CLEar, 208
 :CALCulate:COMParator:CONDition{1-4}:MODE, 209
 :CALCulate:COMParator:CONDition{1-4}:NOMinal, 210
 :CALCulate:COMParator:CONDition{1-4}:PARAmeter, 211
 :CALCulate:COMParator:CONDition{1-4}:SNUMber, 212
 :CALCulate:COMParator:COUNt:CLEar, 213
 :CALCulate:COMParator:COUNt[:STATe], 213
 :CALCulate:COMParator:DATA:BCOUNt?, 214
 :CALCulate:COMParator:DATA:BIN?, 215
 :CALCulate:COMParator:DATA:RDC?, 216
 :CALCulate:COMParator:OGBins, 217
 :CALCulate:COMParator:RDC:LIMit, 218
 :CALCulate:COMParator[:STATe], 205
 :CALCulate[:MATH]:EXAMine:GET?, 219
 :CALCulate[:MATH]:EXAMine[:MEMory]:POINT?, 220
 :CALCulate[:MATH]:EXAMine[:MEMory]:SIZE, 221
 :CALCulate[:MATH]:EXAMine[:MEMory]:START, 222
 :CALCulate:PARAmeter{1-4}:FORMat, 224
 :CALCulate:PARAmeter{1-4}[:MATH]:EXPRession:CENTer, 222
 :CALCulate:PARAmeter{1-4}[:MATH]:EXPRession:NAME, 223
 :CALCulate:PARAmeter{1-4}[:MATH]:EXPRession:STATe, 223
 :DATA[:DATA]:CAD{1-8}?, 253
 :DATA[:DATA]:CCO{1-6}, 254
 :DATA[:DATA]:CMD{1-2}?, 255
 :DATA[:DATA]:CMP{1-3}, 256
 :DATA[:DATA]:FDATA{1-4}?, 257
 :DATA[:DATA]:IMON?, 257
 :DATA[:DATA]:RAW?, 258
 :DATA[:DATA]:RCAD{1-3}?, 259
 :DATA[:DATA]:RCCO{1-3}, 259
 :DATA[:DATA]:RCMD{1-2}?, 260
 :DATA[:DATA]:RCMP{1-3}, 260
 :DATA[:DATA]:RDC?, 261
 :DATA[:DATA]:VMON?, 261
 :DISPlay:BACKlight, 262
 :DISPlay:UPDate, 273
 :DISPlay[:WINDow][:STATe], 262
 :DISPlay[:WINDow]:TEXT1:CALCulate{11-12}:DIG, 266
 :DISPlay[:WINDow]:TEXT1:CALCulate{11-12}:FIX, 267
 :DISPlay[:WINDow]:TEXT1:CALCulate{11-12}:MSD, 267
 :DISPlay[:WINDow]:TEXT1:CALCulate{11-12}[:STATe], 266
 :DISPlay[:WINDow]:TEXT1:CALCulate{1-4}:DIGit, 264
 :DISPlay[:WINDow]:TEXT1:CALCulate{1-4}:FIX, 265
 :DISPlay[:WINDow]:TEXT1:CALCulate{1-4}:MSD, 265
 :DISPlay[:WINDow]:TEXT1:CALCulate{1-4}[:STATe], 264
 :DISPlay[:WINDow]:TEXT1:CALCulate13:DIG, 268
 :DISPlay[:WINDow]:TEXT1:CALCulate13:FIX, 268
 :DISPlay[:WINDow]:TEXT1:CALCulate13:MSD, 269
 :DISPlay[:WINDow]:TEXT1[:STATe], 263
 :DISPlay[:WINDow]:TEXT10:DATA, 270
 :DISPlay[:WINDow]:TEXT10[:STATe], 270
 :DISPlay[:WINDow]:TEXT11:MODE, 271
 :DISPlay[:WINDow]:TEXT11[:STATe], 271
 :DISPlay[:WINDow]:TEXT2:LABel{1-4}, 272
 :DISPlayCCLear, 263
 :FETCh?, 274
 :FORMat:BORDER, 277
 :FORMat[:DATA], 276
 :HCOPY:ABORt, 278
 :HCOPY:CONTent, 278
 :HCOPY:DPRinter, 279
 :HCOPY:IMAGe, 280
 :HCOPY[:IMMEDIATE], 278
 :HCOPY:PRINters?, 280
 :INITiate:CONTinuous, 281
 :INITiate:IMMEDIATE, 281
 :MMEM:LOAD, 284
 :MMEM:STORE, 285
 :READ?, 287
 [:SENSe]:CORRection1[:STATe]?, 225
 [:SENSe]:CORRection1:CKIT, 225
 [:SENSe]:CORRection1:CKIT:LIST[:STATe], 226
 [:SENSe]:CORRection1:CKIT:STANdard1:DC, 227
 [:SENSe]:CORRection1:CKIT:STANdard1:EDELay[:TIME], 228
 [:SENSe]:CORRection1:CKIT:STANdard1:LIST, 229
 [:SENSe]:CORRection1:CKIT:STANdard2:DC, 230
 [:SENSe]:CORRection1:CKIT:STANdard2:EDELay[:TIME], 231
 [:SENSe]:CORRection1:CKIT:STANdard2:LIST, 232
 [:SENSe]:CORRection1:CKIT:STANdard3:DC, 233
 [:SENSe]:CORRection1:CKIT:STANdard3:EDELay[:TIME], 234
 [:SENSe]:CORRection1:CKIT:STANdard3:FORMat, 235

[:SENSe]:CORRection1:CKIT:STANdard3:LIST, 236
[:SENSe]:CORRection1:COLLect[:ACQuire], 238
[:SENSe]:CORRection1:COLLect[:ACQuire]:DC, 239
[:SENSe]:CORRection1:COLLect[:ACQuire]:RF, 240
[:SENSe]:CORRection1:COLLect:SAVE, 240
[:SENSe]:CORRection2:CKIT, 241
[:SENSe]:CORRection2:CKIT:LIST[:STATe], 241
[:SENSe]:CORRection2:CKIT:STANdard1:DC, 242
[:SENSe]:CORRection2:CKIT:STANdard1:LIST, 243
[:SENSe]:CORRection2:CKIT:STANdard2:DC, 244
[:SENSe]:CORRection2:CKIT:STANdard2:LIST, 245
[:SENSe]:CORRection2:COLLect[:ACQuire], 246
[:SENSe]:CORRection2:COLLect[:ACQuire]:DC, 247
[:SENSe]:CORRection2:COLLect[:ACQuire]:RF, 248
[:SENSe]:CORRection2:COLLect:OPEN[:STATe], 248
[:SENSe]:CORRection2:COLLect:SAVE, 249
[:SENSe]:CORRection2:COLLect:SHORT[:STATe], 249
[:SENSe]:CORRection2:FIXTure, 250
[:SENSe]:CORRection2:FIXTure:EDELay:DISTance, 251
[:SENSe]:CORRection2:FIXTure:LABel, 252
:SOURce:LIST, 288
:SOURce:LIST:CLEar, 289
:SOURce:LIST:POINT, 289
:SOURce:LIST:RDC, 290
:SOURce:LIST:RDC:AVERage, 305
:SOURce:LIST:RDC:OFSCancel, 290
:SOURce:LIST:SIZE?, 290
:SOURce:LIST:STATe, 291
:SOURce:LIST:TABLE, 291
:SOURce:UNIT, 292
:STATus:OPERation:CONDition?, 293
:STATus:OPERation:ENABLE, 293
:STATus:OPERation[:EVENT]?, 293
:STATus:OPERation:NTRansition, 294
:STATus:OPERation:PTRansition, 294
:STATus:PRESet, 295
:STATus:QUEStionable:ENABLE, 295
:STATus:QUEStionable[:EVENT]?, 295
:SYSTem:BEEPer1[:IMMediate], 296
:SYSTem:BEEPer1:STATe, 296
:SYSTem:BEEPer2[:IMMediate], 296
:SYSTem:BEEPer2:STATe, 297
:SYSTem:DATE, 297
:SYSTem:ERRor:COUNT?, 298
:SYSTem:ERRor?, 298
:SYSTem:EXTRef?, 298
:SYSTem:KLOCK[:FPANel], 299, 309
:SYSTem:KLOCK:KBD, 299, 309
:SYSTem:KLOCK:MOUSE, 300
:SYSTem:POFF, 300
:SYSTem:PRESet, 300
:SYSTem:TIME, 301
:SYSTem:VERSion?, 301
:TRIGger[:SEQuence1]:DELay, 302
:TRIGger[:SEQuence1][:IMMediate], 302
:TRIGger[:SEQuence1]:SOURce, 304
:TRIGger:SEQuence2:DELay, 303

:TRIGger:SLOPe, 303
Lookup, 17
GPIB Commands Correspondence Table, 337
GPIB trigger, 67

H

Handler Interface
Setting the power supply, 151
Setting the pull-up resistors, 152
Handler interface
Electrical characteristics
Input signals, 149
Output signals, 147
Output, 144
pin layout, 142
Setting the pull-up resistors, 152
Timing chart, 146
Histogram, 119
How to use this manual, 17

I

Idle state, 66
Image, 362
Impedance measurement
Retrieving measurement results, 85
Initial Settings, 352
Initialize
Bin count, 111
Bin sort(Comparator) setup table, 106
Error queue, 198
Instrument, 200, 300
Measurement point(Stimulus) setup table, 27
Status register, 198, 295
Input signal drive voltage, 150
Interactive control, 164
Internal clock
Display on/off, 31
Set
Date, 297
Time, 301
Internal data arrays, 78
Internal data processing, 77
Internal trigger, 67
IP address
Factory setting, 358
How to set, 159

K

Key lock
Front panel, 299, 309
Keyboard, 299, 309
Mouse, 300

L

LAN, 157
Enable/Disable, 160

-
- Setting an IP address, 159
 - LAN trigger, 67
 - Level, 27
 - Level monitor array, 82
 - Level(Power), 27
 - Limit mode, 107
 - Limit range
 - For bin sorting, 106
 - For Rdc measurement, 28
 - List measurement, 28
 - List measurement result
 - Print, 362
 - List meaurement
 - Screen setting, 31
 - Load, 38
 - Local Area Network, 157
 - Local key, 24
 - Lock
 - Front panel, 299, 309
 - Keyboard, 299, 309
 - Mouse, 300
 - Looking up commands, 17
 - Lp, 26
 - Ls, 26
 - lvl_mon.bas, 100
- M**
- Manual trigger, 67
 - Maximum data size, 118
 - Mean value, 119
 - meas_ary.bas, 190
 - meas_fxt.bas, 170
 - meas_sys.bas, 179
 - Measurement example, 167
 - Measurement failure, 350
 - Measurement parameters, 26
 - Retrieving measurement results, 85
 - Measurement point, 28
 - Measurement point delay time, 303
 - Measurement point setup table
 - Print, 362
 - Setting, 27
 - Measurement start delay time, 146
 - Measurement state, 68
 - Measuring array components, 186
 - Messages, 368
 - Modification of the handler interface, 151
 - Most significant digit, 30
 - MSD, 30
- N**
- Negative transition filter, 314
 - Net mask, 159
 - Network, 157
 - Network device, 160
 - No good bin, 107
 - Number of digits, 30
 - Number of measurement points, 27
- O**
- Offset cancel function, 28
 - Offset delay time, 38
 - Open, 38, 52
 - Operation manual, 4
 - Operation status register, 315
 - Bit definitions, 318
 - Reads condition register, 293
 - Reads event register, 293
 - Sets enable register, 293
 - Sets negative transition filter, 294
 - Sets positive transition filter, 294
 - OUT_OF_GOOD_BINS line, 107
 - Output signal pull-up voltage, 150
 - Overload, 350
 - Ovld, 350
- P**
- Parameters, 26
 - Percent tolerance mode, 107
 - Pin layout, 142
 - Point delay time, 303
 - Point number, 28
 - Port extension compensation
 - Selecting a fixture, 51
 - Positive transition filter, 314
 - Power, 27
 - Power off, 140
 - Power supply of handler interface, 151
 - Preset, 200, 300
 - Preset values, 352
 - Press, 21
 - Printer, 361
 - printer.bas, 364
 - Procedure to remove the handler interface, 154
 - Product information, 199
 - Programming example
 - File name
 - bin_sort.bas, 114
 - calib.bas, 46
 - compen.bas, 60
 - data.bas, 95
 - fetch.bas, 92
 - file_sav.bas, 129
 - filelist.bas, 132
 - lvl_mon.bas, 100
 - meas_ary.bas, 190
 - meas_fxt.bas, 170
 - meas_sys.bas, 179
 - printer.bas, 364
 - rdc.bas, 103
 - read.bas, 97
 - setup.bas, 34
 - srq_err.bas, 137
 - srq_meas.bas, 71

- stat.bas, 122
- trg.bas, 87
- trg_real.bas, 89
- Title
 - Calibration, 46
 - Compensation, 60
 - Detecting an error via SRQ, 137
 - Detecting the end of measurement using an SRQ, 71
 - File listing, 132
 - File save, 129
 - Measuring array components, 190
 - Measuring the DUT with a test fixture, 170
 - Printer, 364
 - Retrieving Rdc measurement results, 103
 - Retrieving the monitored values of test signal levels, 100
 - Setting measurement conditions, 34
 - Statistic analysis, 122
 - Using an auto-sorting system, 179
 - Using the *TRG command to retrieve measurement results in a binary format, 89
 - Using the *TRG command to retrieve measurement results in the ASCII format, 87
 - Using the :DATA:FDAT{1-4}? command to retrieve measurement results, 95
 - Using the :FETC? command to retrieve measurement results, 92
 - Using the :READ? command to retrieve measurement results, 97
 - Using the bin sorting function to sort DUTs, 114
- Pull-up resistor, 147
- Pull-up voltage, 150
- Q**
- Q, 26
- Questionable status register, 315
 - Bit definitions, 318
 - Reads event register, 295
 - Sets enable register, 295
- R**
- Rdc measurement
 - averaging factor, 305
 - Calibration coefficient, 83
 - Calibration data, 83
 - Compensation coefficients, 84
 - Compensation data, 84
 - Display data, 83
 - Limit setting, 28
 - Offset cancel function, 28
 - On/off setting, 28
 - Retrieving comparator results, 101
 - Retrieving measurement results, 101
- Rdc out of range, 350
- rdc.bas, 103
- read.bas, 97
- Recall, 127
- Recalled settings, 352
- Remote mode, 24
- Reset
 - Bin count, 111
 - Bin sort(Comparator) setup table, 106
 - Error queue, 198
 - Instrument, 200, 300
 - Measurement point(Stimulus) setup table, 27
 - Status register, 198, 295
- Reset values, 352
- Resistor, 147
- Retrieving bin sorting results, 110
- Retrieving comparator results, 110
 - Rdc measurement, 101
- Retrieving measurement results
 - Measurement parameters 1 through 4, 85
 - Rdc measurement, 101
- Retrieving sorting results, 110
- Rp, 26
- Rs, 26
- S**
- σ , 119
- Sample program
 - File name
 - bin_sort.bas, 114
 - calib.bas, 46
 - compen.bas, 60
 - data.bas, 95
 - fetch.bas, 92
 - file_sav.bas, 129
 - filelist.bas, 132
 - lvl_mon.bas, 100
 - meas_ary.bas, 190
 - meas_fxt.bas, 170
 - meas_sys.bas, 179
 - printer.bas, 364
 - rdc.bas, 103
 - read.bas, 97
 - setup.bas, 34
 - srq_err.bas, 137
 - srq_meas.bas, 71
 - stat.bas, 122
 - trg.bas, 87
 - trg_real.bas, 89
 - How to load, 17
 - Title
 - Calibration, 46
 - Compensation, 60
 - Detecting an error via SRQ, 137
 - Detecting the end of measurement using an SRQ, 71
 - File listing, 132
 - File save, 129
 - Measuring array components, 190
 - Measuring the DUT with a test fixture, 170
 - Printer, 364
 - Retrieving Rdc measurement results, 103
 - Retrieving the monitored values of test signal levels, 100

- Setting measurement conditions, 34
 - Statistical analysis, 122
 - Using an auto-sorting system, 179
 - Using the *TRG command to retrieve measurement results in a binary format, 89
 - Using the *TRG command to retrieve measurement results in the ASCII format, 87
 - Using the :DATA:FDAT{1-4}? command to retrieve measurement results, 95
 - Using the :FETC? command to retrieve measurement results, 92
 - Using the :READ? command to retrieve measurement results, 97
 - Using the bin sorting function to sort DUTs, 114
 - Save, 126
 - Saved settings, 352
 - Scanner, 186
 - Selecting a fixture, 51
 - Self-test, 202
 - Sequence operation state, 68
 - Serial number plate, 308
 - Service command, 305
 - Service request, 312
 - Example
 - error detection, 135
 - Waiting for end of measurement, 70
 - Service request enable register, 312
 - Setting, 201
 - Setting the beep condition, 205
 - Setting the decimal point, 30
 - Setting the number of digits, 30
 - Setup table
 - Print, 362
 - Setting
 - Bin sort(Comparator), 106
 - Calibration kit, 38
 - Compensation kit, 52
 - Measurement point(Stimulus), 27
 - setup.bas, 34
 - Short, 38, 52
 - Shutdown, 140
 - Single-point measurement, 28
 - Sort result output hold time, 146
 - Sort result output setup time, 146
 - Sorting flow, 109
 - Sorting results, 110
 - SRQ, 312
 - Example
 - error detection, 135
 - Waiting for end of measurement, 70
 - srq_err.bas, 137
 - sta, 126
 - Standard definition
 - Calibration, 38
 - Compensation, 52
 - Standard deviation, 119
 - Standard event status register, 315
 - Bit definitions, 317
 - Reads event register, 199
 - Sets enable register, 198
 - Standby switch, 140
 - Starting (triggering) measurement, 69
 - stat.bas, 122
 - Statistical analysis function
 - Setting the maximum data size, 118
 - Statistical analysis function
 - Performing statistical analysis, 119
 - Status byte register, 313
 - Bit definitions, 316
 - Reads out the value, 201
 - Status register
 - Example
 - error detection, 135
 - Waiting for end of measurement, 70
 - model, 312
 - Register structure, 315
 - Status reporting system, 312
 - Stimulus setup table
 - Setting, 27
 - Subnet mask, 159
 - Support printer, 361
 - Switching the measurement point, 28
- T**
- 0, 26
 - Table number, 27
 - telnet, 164
 - Test fixture selection, 51
 - Test signal, 27
 - Frequency, 27
 - Test signal level
 - Monitor array, 82
 - Retrieving monitored values, 99
 - Time
 - Set, 301
 - Show or hide, 31
 - Title display area, 31
 - Tolerance mode, 107
 - Transferring files, 161
 - Transition filter, 314
 - trg.bas, 87
 - trg_real.bas, 89
 - Trigger delay time, 302
 - Trigger Event Detect state, 67
 - Trigger pulse width, 146
 - Trigger setup time, 146
 - Trigger source, 67
 - Trigger system, 66
- U**
- Update
 - Display, 31
 - Time, 31
 - User-defined calibration kit, 38

V

- Voltage level
 - Retrieving monitored values, 99
 - Setting, 27
- Voltage monitor array, 82

W

- Waiting for end of measurement, 70
- Waiting for Trigger state, 67

X

- X, 26

Y

- Y, 26

Z

- Z, 26